

SCG200 vSZ-H and SZ300 Administrator Guide

Supporting 3.6

Copyright Notice and Proprietary Information

Copyright 2017 Brocade Communications Systems, Inc. All rights reserved.

No part of this documentation may be used, reproduced, transmitted, or translated, in any form or by any means, electronic, mechanical, manual, optical, or otherwise, without prior written permission of or as expressly provided by under license from Brocade.

Destination Control Statement

Technical data contained in this publication may be subject to the export control laws of the United States of America. Disclosure to nationals of other countries contrary to United States law is prohibited. It is the reader's responsibility to determine the applicable regulations and to comply with them.

Disclaimer

THIS DOCUMENTATION AND ALL INFORMATION CONTAINED HEREIN ("MATERIAL") IS PROVIDED FOR GENERAL INFORMATION PURPOSES ONLY. BROCADE and RUCKUS WIRELESS, INC. AND THEIR LICENSORS MAKE NO WARRANTY OF ANY KIND, EXPRESS OR IMPLIED, WITH REGARD TO THE MATERIAL, INCLUDING, BUT NOT LIMITED TO, THE IMPLIED WARRANTIES OF MERCHANTABILITY, NON-INFRINGEMENT AND FITNESS FOR A PARTICULAR PURPOSE, OR THAT THE MATERIAL IS ERROR-FREE, ACCURATE OR RELIABLE. BROCADE and RUCKUS RESERVE THE RIGHT TO MAKE CHANGES OR UPDATES TO THE MATERIAL AT ANY TIME.

Limitation of Liability

IN NO EVENT SHALL BROCADE or RUCKUS BE LIABLE FOR ANY DIRECT, INDIRECT, INCIDENTAL, SPECIAL OR CONSEQUENTIAL DAMAGES, OR DAMAGES FOR LOSS OF PROFITS, REVENUE, DATA OR USE, INCURRED BY YOU OR ANY THIRD PARTY, WHETHER IN AN ACTION IN CONTRACT OR TORT, ARISING FROM YOUR ACCESS TO, OR USE OF, THE MATERIAL.

Trademarks

Ruckus Wireless, Ruckus, the bark logo, BeamFlex, ChannelFly, Dynamic PSK, FlexMaster, Simply Better Wireless, SmartCell, SmartMesh, SmartZone, Unleashed, ZoneDirector and ZoneFlex are trademarks of Ruckus Wireless, Inc. in the United States and in other countries. Brocade, the B-wing symbol, MyBrocade, and ICX are trademarks of Brocade Communications Systems, Inc. in the United States and in other countries. Other trademarks may belong to third parties.

Contents

Preface	11
Document conventions.....	11
Notes, cautions, and warnings.....	11
Command Syntax Conventions.....	12
Document feedback.....	12
Ruckus resources.....	12
Online training resources.....	13
Contacting Ruckus Technical Support.....	13
Navigating the Dashboard	15
Setting Up the Controller for the First Time.....	15
Logging On to the Web Interface.....	15
Web Interface Features.....	16
Changing the Administrator Password.....	17
Logging Off the Controller.....	18
Configuring Global Filters.....	19
Warnings and Notifications.....	20
Warnings.....	20
Setting Global Notifications.....	21
Health and Maps.....	21
Understanding Cluster and AP Health Icons.....	22
Customizing Health Status Thresholds.....	22
Using the Health Dashboard Map.....	24
Traffic Analysis.....	29
Configuring Traffic Analysis Display for APs.....	30
Configuring Traffic Analysis Display for WLANs.....	31
Configuring Traffic Analysis Display for Top Clients.....	32
Configuring System Settings	33
Configuring General Settings.....	33
Viewing System Settings.....	33
Configuring System Time.....	34
Configuring the Remote Syslog Server.....	35
Configuring SCI Settings.....	37
Setting the Northbound Portal Password.....	37
Enabling Global SNMP Notifications.....	37
Configuring SMTP Server Settings.....	39
Configuring FTP Server Settings.....	40
Configuring the SMS Gateway Server.....	41
Configuring Node Affinity.....	41
Configuring AP Settings.....	42
Working with AP Registration Rules.....	42
Creating vSZ-D Zone Affinity.....	43
Tagging Critical APs.....	44
Configuring the Tunnel UDP Port.....	44
Setting the Country Code.....	44
Limiting the Number of APs in a Domain or Zone.....	45

Viewing the System Cluster Overview.....	47
Control Planes and Data Planes.....	47
Interface and Routing.....	48
Displaying the Chassis View of Cluster Nodes.....	49
Enabling Cluster Redundancy.....	49
Configuring the Control Plane.....	51
Configuring the Data Plane.....	55
Monitoring Cluster Settings.....	58
Working with Maps.....	59
Importing a Floorplan Map.....	59
Viewing RF Signal Strength.....	62
Monitoring APs Using the Map View.....	62
Certificates.....	63
Importing New Certificates.....	64
Assigning Certificates to Services.....	64
Generating Certificate Signing Request (CSR).....	65
Managing AP Certificates.....	66
Importing Trusted CA Certificates.....	67
Configuring Templates.....	67
Working with Zone Templates.....	67
Working with WLAN Templates.....	72
Working With Access Points.....	75
Understanding the System, Domains, Zones and AP Groups.....	75
Hierarchy Overview.....	75
Creating an AP Domain.....	76
Working with AP Zones.....	76
Working with AP Groups.....	83
Monitoring Domains, Zones, and AP Groups.....	91
Viewing Modes.....	94
AP Status.....	94
Configuring Access Points.....	94
Managing Access Points.....	97
Overview of Access Point Configuration.....	97
Viewing Managed Access Points.....	98
Downloading the Support Log from an Access Point.....	98
Provisioning and Swapping Access Points.....	99
Editing Swap Configuration.....	100
Monitoring Access Points.....	101
Working with WLANs and WLAN Groups.....	105
Domains, Zones, AP Groups, and WLANs.....	105
Viewing Modes.....	105
Creating a WLAN Domain for an MSP.....	106
WLAN Groups.....	106
Creating a WLAN Group.....	106
Creating a WLAN Configuration.....	107
802.11 Fast BSS Transition.....	119
802.11w MFP.....	119
Band Balancing.....	119
Bypassing Apple CNA.....	119

Channel Mode.....	119
Client Admission Control.....	120
Client Load Balancing.....	120
Mobility Domain ID.....	120
Portal-based WLANs.....	121
Rate Limiting Ranges for Policies.....	122
Working with WLAN Schedule Profiles.....	122
Managing WLANs.....	123
Moving a Single WLAN to a Different WLAN Zone.....	124
Extracting a WLAN Template.....	124
Applying a WLAN Template.....	125
Triggering a Preferred Node.....	125
Managing Clients.....	127
Working with Wireless Clients.....	127
Viewing a Summary of Wireless Clients.....	127
Viewing Information about a Wireless Client.....	128
Deauthorizing a Wireless Client.....	129
Blocking a Wireless Client.....	129
Unblocking a Wireless Client.....	129
Disconnecting a Wireless Client.....	130
Working with Wired Clients.....	130
Viewing a Summary of Wired Clients.....	130
Viewing Information about a Wired Client.....	130
Deauthorizing a Wired Client.....	131
Working with Users and Roles.....	131
Creating a User Role.....	131
Creating a User Role with Active Directory Authentication.....	132
Creating a User Role with 802.1x Authentication.....	133
Limitations Applying Role Policies to Users.....	133
Creating a Local User.....	134
Creating a Subscription Package.....	136
Working with Guest Passes.....	137
Generating Guest Passes.....	138
Creating a Guest Pass Template.....	142
Creating a Guest Instruction SMS Template.....	143
Exporting the Guest Pass to CSV.....	145
Generating Guest Passes from an Imported CSV.....	145
Sending the Guest Pass via Email.....	147
Printing the Guest Pass.....	148
Sending the Guest Pass via SMS.....	149
Working with Dynamic PSKs.....	150
Viewing Dynamic PSKs.....	151
Generating Dynamic PSKs.....	151
Importing Dynamic PSKs.....	152
Creating an External DPSK Over RADIUS WLAN.....	154
Application Recognition and Control.....	157
Monitoring Applications.....	157
Services and Profiles.....	161
Working with Hotspots and Portals.....	161

Creating a Guest Access Portal.....	161
Working with Hotspot (WISPr) Services.....	163
Creating a Web Authentication Portal.....	166
Creating a WeChat Portal.....	167
Working with Hotspot 2.0 Services.....	169
Creating a UA Blacklist Profile.....	175
Configuring Access Control.....	177
Creating a User Traffic Profile.....	177
Creating OS Policy Service.....	179
VLAN Pooling.....	181
Create Precedence Profile.....	183
Creating an L2 Access Control Service.....	184
Creating Blocked Clients.....	185
Creating a Client Isolation Whitelist.....	186
Creating Time Schedules.....	187
Creating a DNS Server Profile.....	188
Configuring Application Controls.....	189
Creating an Application Control Policy.....	190
Implementing an Application Control Policy.....	191
Creating a User Defined Application.....	194
Importing an Application Signature Package.....	196
URL Filtering.....	197
Limitations.....	197
Viewing a Summary of URL Filters.....	197
Creating a URL Filtering Policy.....	198
Enabling URL Filtering on the Controller.....	201
Enabling URL Filtering in the User Traffic Profile.....	202
Managing URL Filtering Licenses.....	203
Authentication.....	203
Creating Non-Proxy Authentication AAA servers.....	203
Creating Proxy AAA Servers.....	206
Creating Realm Based Authentication Profile.....	213
Accounting.....	215
Creating Non-Proxy Accounting AAA Servers.....	215
Creating Proxy Accounting AAA Servers.....	216
Creating Realm Based Proxy.....	217
Classifying Rogue Policy.....	218
Bonjour.....	219
Bonjour Gateway.....	220
Bonjour Fencing.....	222
Working with Tunnels and Ports.....	225
Creating a Ruckus GRE Profile.....	225
Creating a Soft GRE Profile.....	226
Creating an IPsec Profile.....	228
Creating an Ethernet Port Profile.....	230
Creating a Tunnel DiffServ Profile.....	233
Communications Assistance for Law Enforcement Act (CALEA).....	235
Enabling Flexi VPN.....	235
Enabling L3 Roaming Criteria for vDPs.....	236
Enabling Tunnel Encryption.....	238

Managing Core Network Tunnels.....	239
Creating Bridge Forwarding Profiles.....	239
Creating L2oGRE Forwarding Profiles.....	241
Location Services.....	244
DHCP/NAT.....	245
AP-based DHCP/NAT.....	245
Profile-based DHCP.....	245
Profile-based NAT.....	246
Caveats and Limitations.....	246
Configuring AP-based DHCP Service Settings.....	246
Creating an AP DHCP Pool.....	251
Creating Profile-based DHCP.....	253
Creating Profile-based NAT.....	255
Working with Reports.....	257
Types of Reports.....	257
Client Number Report.....	257
Continuously Disconnected APs Report.....	257
System Resource Utilization Report.....	257
TX/RX Bytes Report.....	257
Managing Report Generation.....	257
Creating Reports.....	258
Generating Reports.....	259
Rogue Access Points.....	260
Viewing Rogue Access Points.....	260
Marking Rogue Access Points.....	260
Locating a Rogue Access Point.....	261
Historical Client Stats.....	261
Viewing AP Client Statistics.....	261
Ruckus AP Tunnel Stats.....	262
Viewing Statistics for Ruckus GRE Tunnels.....	262
Viewing Statistics for SoftGRE Tunnels.....	263
Viewing Statistics for SoftGRE IPsec Tunnels.....	264
Core Network Tunnel Stats.....	265
Viewing Statistics for SoftGRE Core Network Tunnel.....	265
Troubleshooting.....	267
Troubleshooting Client Connections.....	267
Troubleshooting through Spectrum Analysis.....	268
Administering the Controller.....	271
Managing Administrator and Roles.....	271
Creating User Groups.....	271
Creating Administrator Accounts.....	272
Creating a RADIUS Server for Administrator Authentication.....	273
Enabling the Access Control List.....	274
Backing Up and Restoring Clusters.....	275
Creating a Cluster Backup.....	275
Backing Up and Restoring the Controller's Network Configuration from an FTP Server.....	276
Backing up Cluster Configuration.....	284
Upgrading the Controller.....	286
Performing the Upgrade.....	286

Uploading an AP Patch File.....	287
Verifying the Upgrade.....	288
Rolling Back to a Previous Software Version.....	288
Upgrading the Data Plane.....	288
Managing Licenses.....	290
Viewing Installed Licenses.....	290
Configuring the License Server.....	292
Configuring License Bandwidth.....	292
ZoneDirector to SmartZone Migration.....	293
Monitoring Administrator Activities.....	294
Managing Mobile Virtual Network Operator (MVNO) Accounts.....	294
Managing Events and Alarms.....	297
Viewing Events.....	297
Sending SNMP Traps and Email Notifications for Events.....	297
Configuring Event Threshold.....	298
Configuring Alarms.....	299
Clearing Alarms.....	299
Acknowledging Alarms.....	299
Applying Filters.....	300
Diagnostics.....	301
Applying Scripts.....	301
Applying AP CLI Scripts.....	301
Viewing and Downloading Logs.....	302
Available System Logs for SCG200, vSZ-H and SZ300.....	302
Viewing RADIUS Proxy Settings.....	304
Viewing RADIUS Server Settings.....	304
Viewing DHCP Relay Settings.....	304
Statistics Files the Controller Exports to an FTP Server.....	307
Ports to Open for AP-SCG/SZ/vSZ/vSZ-D Communication.....	309
SoftGRE Support.....	313
Overview of SoftGRE Support.....	313
Supported Deployment Scenario.....	313
SoftGRE Packet Format.....	314
Configuring And Monitoring AP Zones.....	315
SoftGRE SNMP MIBs.....	316
SoftGRE Events and Alarms.....	317
SoftGRE Events.....	317
SoftGRE Alarms.....	318
Replacing Hardware Components.....	319
Installing or Replacing Hard Disk Drives.....	319
Ordering a Replacement Hard Disk.....	319
Removing the Front Bezel.....	319
Removing an HDD Carrier from the Chassis.....	320
Installing a Hard Drive in a Carrier.....	321
Reinstalling the Front Bezel.....	324
Replacing PSUs.....	325
Replacing System Fans.....	325

Replacing a Controller Node.....	329
Introduction.....	329
Backing Up and Resorting the Cluster.....	329
Step 1: Backing Up the Cluster from the Web Interface.....	329
Step 2: Back Up the Cluster from the Controller CLI.....	329
Step 3: Transfer the Cluster Backup File to an FTP Server.....	330
Step 4: Restoring the Cluster Backup to the Controller.....	332
Backing Up and Restoring Configuration.....	335
Backed Up Configuration Information.....	335
Backing Up Configuration.....	335
Restoring Configuration.....	336
SCG SSID Syntax.....	341
SSIDs Supported in Release 1.1.x.....	341
SSIDs Supported in Release 2.1.x.....	341
SSIDs Supported in Release 2.5.x.....	342
SSIDs Supported in Release 3.0 and Above.....	342
ZoneDirector SSID Syntax.....	343
SSIDs Supported in Releases 9.8 and 9.7.....	343
Supported SSIDs in ZoneFlex Release 9.6.....	343
ZoneFlex AP SSID Syntax.....	344
Supported SSIDs in Releases 9.8, 9.7, and 9.6.....	344

Preface

- Document conventions.....11
- Command Syntax Conventions..... 12
- Document feedback..... 12
- Ruckus resources.....12
- Online training resources..... 13
- Contacting Ruckus Technical Support..... 13

Document conventions

The following tables list the text and notice conventions that are used throughout this guide.

TABLE 1 Text conventions

Convention	Description	Example
monospace	Represents information as it appears on screen	[Device name]>
default font bold	UI components such as screen or page names, keyboard keys, software buttons, and field names CLI command names and keywords	On the Start menu, click All Programs . ruckus# show running-config ap-heartbeat
<i>italics</i>	Publication titles CLI command modifiers and variables.	Refer to the <i>SmartZone™ (SZ) 100 and Virtual SmartZone Essentials (vSZ-E) Command Reference</i> for more information ap- mac

Notes, cautions, and warnings

Notes, cautions, and warning statements may be used in this document. They are listed in the order of increasing severity of potential hazards.

NOTE

A Note provides a tip, guidance, or advice, emphasizes important information, or provides a reference to related information.



CAUTION

A Caution statement alerts you to situations that can be potentially hazardous to you or cause damage to hardware, firmware, software, or data.



DANGER

A Danger statement indicates conditions or situations that can be potentially lethal or extremely hazardous to you. Safety labels are also attached directly to products to warn of these conditions or situations.

Command Syntax Conventions

Bold and italic text identify command syntax components. Delimiters and operators define groupings of parameters and their logical relationships.

Convention	Description
bold text	Identifies command names, keywords, and command options.
<i>italic text</i>	Identifies a variable.
[]	Syntax components displayed within square brackets are optional. Default responses to system prompts are enclosed in square brackets.
{ x y z }	A choice of required parameters is enclosed in curly brackets separated by vertical bars. You must select one of the options.
x y	A vertical bar separates mutually exclusive elements.
< >	Nonprinting characters, for example, passwords, are enclosed in angle brackets.
...	Repeat the previous element, for example, <i>member</i> { <i>member</i> ...}.
\	Indicates a "soft" line break in command examples. If a backslash separates two lines of a command input, enter the entire command at the prompt without the backslash.

Document feedback

Ruckus is interested in improving its documentation and welcomes your comments and suggestions.

You can email your comments to Ruckus at: docs@ruckuswireless.com

When contacting us, please include the following information:

- Document title and release number
- Document part number (on the cover page)
- Page number (if appropriate)
- For example:
 - SmartCell Gateway 200 S2a Interface Reference Guide for SmartZone 3.5.1
 - Part number: 800-71306-001
 - Page 88

Ruckus resources

Visit the Ruckus website to locate related documentation for your product and additional Ruckus resources.

Release Notes and other user documentation are available at <https://support.ruckuswireless.com/documents>. You can locate documentation by product or perform a text search.

White papers, data sheets, and other product documentation are available at www.ruckuswireless.com.

Online training resources

To access a variety of online Ruckus training modules, including free introductory courses to wireless networking essentials, site surveys, and Ruckus products, visit the Ruckus Training Portal at:

Go to: <https://training.ruckuswireless.com>.

Contacting Ruckus Technical Support

As a Ruckus customer, you can contact Ruckus Technical Support 24x7 online or by telephone.

For product support information and the latest information on contacting the Support Team, go to www.ruckuswireless.com and select **Support**.

If you have purchased Ruckus product support directly from Ruckus, use one of the following methods to contact the Support Team 24x7.

Online	Telephone
<p>Preferred method of contact for non-urgent issues:</p> <ul style="list-style-type: none">• Case management through the https://support.ruckuswireless.com portal.• Access links to Knowledge Base, Forum, Technical Documents, Software Downloads and Licensing tools	<p>Required for Sev 1-Critical and Sev 2-High issues:</p> <ul style="list-style-type: none">• Continental US: 1-855-782-5871• Canada: 1-855-782-5871• Europe, Middle East, Africa, and Asia Pacific, toll-free numbers are available at https://support.ruckuswireless.com/contact-us and Live Chat is also available.

Navigating the Dashboard

- [Setting Up the Controller for the First Time.....](#) 15
- [Logging On to the Web Interface.....](#) 15
- [Web Interface Features.....](#) 16
- [Changing the Administrator Password.....](#) 17
- [Logging Off the Controller.....](#) 18
- [Configuring Global Filters.....](#) 19
- [Warnings and Notifications.....](#) 20
- [Health and Maps.....](#) 21
- [Traffic Analysis.....](#) 29

Setting Up the Controller for the First Time

The controller must first be set up on the network.

NOTE

Setting up the controller is described in the Getting Started Guide or Quick Setup Guide for your controller platform.

For information on how to set up the controller for the first time, including instructions for running and completing the controller's *Setup Wizard*, see the *Getting Started Guide* or *Quick Setup Guide* for your controller platform.

NOTE

While deploying vSZ, iSCSI must be used for block storage and make the hosts see everything as Direct-attached storage (DAS) for real-time database access/synchronisation as it requires lower latency and a high number of r/w transactions. Due to higher r/w latency, SAN and NAS might not be suitable for vSZ deployment.

Some of the new features (for example, location based services, rogue AP detection, force DHCP, and others) that this guide describes may not be visible on the controller web interface if the AP firmware deployed to the zone you are configuring is earlier than this release. To ensure that you can view and configure all new features that are available in this release, Ruckus Wireless recommends upgrading the AP firmware to the latest version.

Logging On to the Web Interface

Before you can log on to the controller web interface, you must have the IP address that you assigned to the Management (Web) interface when you set up the controller on the network using the Setup Wizard.

Once you have this IP address, you can access the web interface on any computer that can reach the Management (Web) interface on the IP network.

Follow these steps to log on to the controller web interface.

1. On a computer that is on the same subnet as the Management (Web) interface, start a web browser.

Supported web browsers include:

- Google Chrome 47 and later (recommended)
- Safari 7 and later (Mac OS)
- Mozilla Firefox 44 and later

Navigating the Dashboard

Web Interface Features

- Internet Explorer 11 and later
 - Microsoft Edge
2. In the address bar, type the IP address that you assigned to the Management (Web) interface, and then append a colon and **8443** (the controller's management port number) at the end of the address.

For example, if the IP address that you assigned to the Management (Web) interface is **10.10.101.1**, then you should enter:
https://10.10.101.1:8443

NOTE

The controller web interface requires an **HTTPS** connection. You must append **https** (not **http**) to the Management interface IP address to connect to the web interface. If a browser security warning appears, this is because the default SSL certificate (or security certificate) that the controller is using for HTTPS communication is signed by Ruckus Wireless and is not recognized by most web browsers.

The controller web interface logon page appears.

3. Log on to the controller web interface using the following logon details:
 - **User Name:** admin
 - **Password:** {the password that you set when you ran the Setup Wizard}
4. Click **Log On**.

The web interface refreshes, and then displays the **Dashboard**, which indicates that you have logged on successfully.

Web Interface Features

The web interface is the primary graphical front end for the controller and is the primary interface

You can use it to:

- Manage access points and WLANs
- Create and manage users and roles
- Monitor wireless clients, managed devices, and rogue access points
- View alarms, events, and administrator activity
- Generate reports
- Perform administrative tasks, including backing up and restoring system configuration, upgrading the cluster, downloading support , performing system diagnostic tests, viewing the status of controller processes, and uploading additional licenses (among others)

FIGURE 1 Controller Web Interface Features

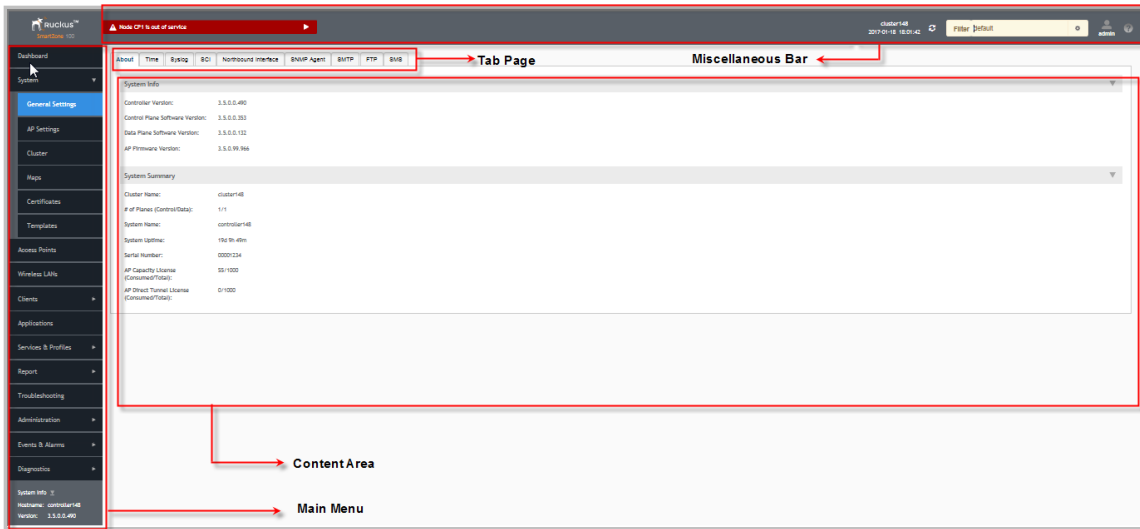

The following table describes the web interface features.

TABLE 2 Controller Web Interface Features

Feature	Description	Action
Main Menu	Lists the menus for administrative task.	Select the required menu and sub-menu.
Tab Page	Displays the options specific to the selected menu.	Select the required tab page.
Content Area	Displays tables, forms, and information specific to the selected menu and tab page.	View the tables, forms and information specific to the selected menu, sub-menu and tab page. Double-click an object or profile in a table, for example: a WLAN, to edit the settings.
Header Bar	Displays information specific to the web interface.	Select the required option (from left to right): <ul style="list-style-type: none"> Warning—Lists the critical issues to be resolved. System Date and time—Displays the current system date and time. Refresh—Refreshes the web page. Global filter—Allows you to set the preferred system filter. My Account link—Allows you to: <ul style="list-style-type: none"> Change password Set session preference Log off Online Help—Allows access to web help.

You can also use the  icon to expand and shrink the main menu. Shrinking the main menu increases the size of the content area for better readability and viewing.

Changing the Administrator Password

Follow these steps to change the administrator password.

1. From the **Header** bar, click **admin** and select **Change Password**. The following window appears.

FIGURE 2 Change Password Form

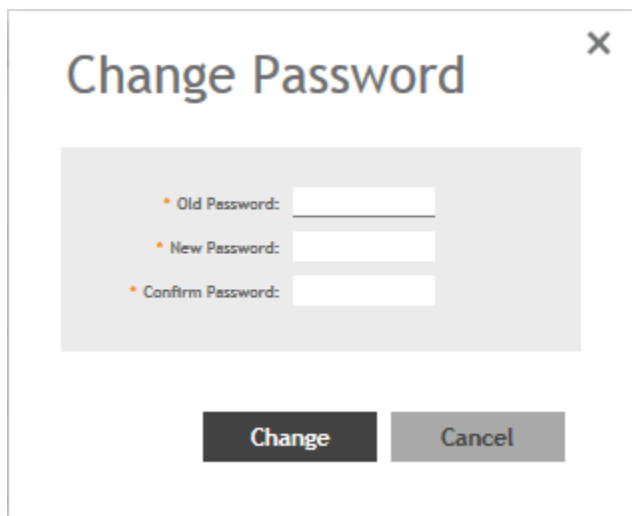

The image shows a web form titled "Change Password" with a close button (X) in the top right corner. The form contains three input fields, each preceded by a red asterisk: "Old Password:", "New Password:", and "Confirm Password:". Below the input fields are two buttons: a dark grey "Change" button and a light grey "Cancel" button.

2. Enter:
 - **Old Password**—Your current password.
 - **New Password**—Your new password.
 - **Confirm Password**—Your new password.
3. Click **Change**, your new password is updated.

Logging Off the Controller

You must be aware of how to log off the controller through CLI and from the web interface.

1. From the **Header** bar, click **admin** and select **Log off**.
The following message appears: Are you sure you want to log off?
2. Click **Yes**.

The controller logs you off the web interface and the logon page appears.

You have completed logging off the web interface.

You can also use CLI commands to shutdown the controller.

To shutdown the controller gracefully, use the following command: **ruckus# shutdown <seconds>**, where *seconds* indicates the number of seconds before controller shutdowns.

To shutdown the controller immediately, use the following command: **ruckus# shutdown now**. The controller would shutdown in 30 seconds.

Configuring Global Filters

The Global filter setting allows you to set your preferred system filter.

Global filters allow the administrator to define a system scope or system context that applies to all pages of the system as they navigate to different menus. For example, if your system includes 5 zones, but you want to view Zone1 and Zone2 only, you can create and apply such a filter. As you navigate throughout the system, the view will be restricted to show only the data, objects, and profiles contained within Zones 1 and 2.

To set the global filter:

1. From the **Header** bar, click **Filter** setting . The below figure appears.

FIGURE 3 Global Filter Form

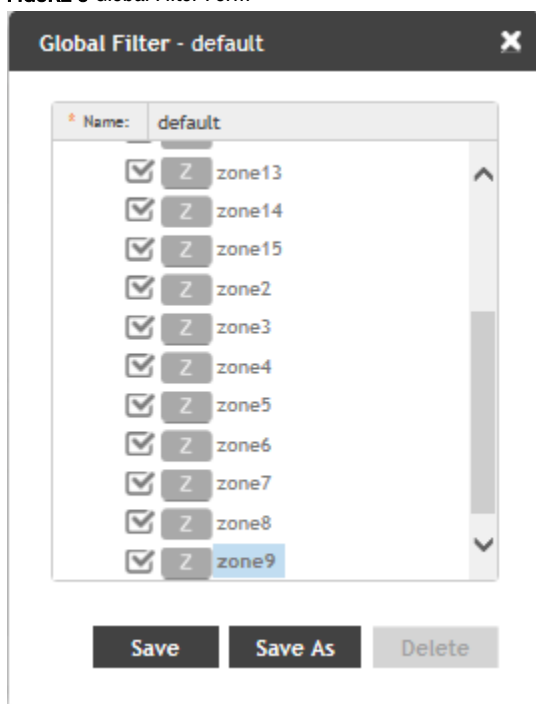

The screenshot shows a dialog box titled "Global Filter - default". At the top, there is a text field labeled "Name:" with the value "default". Below this is a list of zones, each with a checked checkbox and a "Z" icon. The zones listed are zone13, zone14, zone15, zone2, zone3, zone4, zone5, zone6, zone7, zone8, and zone9. The "zone9" entry is highlighted in blue. At the bottom of the dialog, there are three buttons: "Save", "Save As", and "Delete".

2. Select or clear the required system filters and click
 - **Save**—To save the filter settings with the default group.
 - **Save As**—To save the filter settings as a new group. The below figure appears. Enter a new name for the group and click **OK**.

FIGURE 4 New Name Form

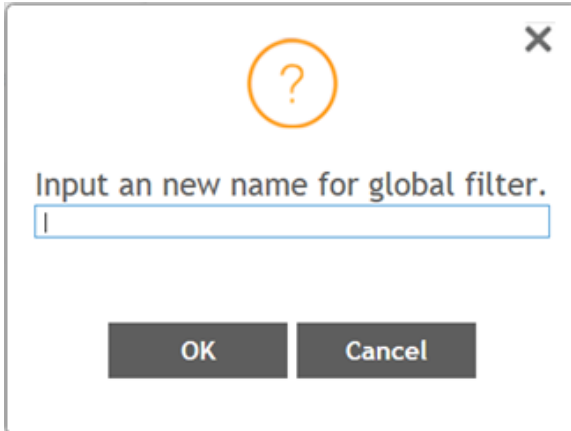

Input an new name for global filter.

OK Cancel

NOTE

You can delete the filter setting. To do so, click the Filter  setting button. The Global Filter form appears, click **Delete**.

Warnings and Notifications

This section explains about warnings and notifications.

Warnings

Warnings are displayed in the Miscellaneous bar. They are issues which are critical in nature. Warnings cannot be removed or acknowledged unless the critical issue is resolved.

FIGURE 5 Sample Warning Message



A list of warning messages that appear are as follows:

- Default 90-day support expiring soon
- System support expiring soon
- System support has expired
- Default 90-day AP license expiring soon
- Default AP license has expired
- Default 90-day RTU license expiring soon
- RTU has expired
- AP Certificate Expiration
- Node Out of Service
- Cluster Out of Service
- VM Resource Mismatch

- Suggested AP Limit Exceeded

Setting Global Notifications

Notifications are integrated with existing alarms and they are displayed only when a notification alarm exists and which is not acknowledged by the administrator. Notifications can be viewed from the **Content** area. Administrators can acknowledge the notification by either:

- Clear the alarm
- Acknowledge the Alarm

Alarm severity are of three types:

- Minor
- Major
- Critical

The administrator can change the alarm severity shown on the dashboard. To do so:

1. From the Notifications area, Click the Setting  button. The Settings - Global Notification form appears.
2. From the **Lowest alarm severity** drop-down, select the required severity level.
3. Click **OK**. Notifications corresponding to the selected alarm severity and severity above it are displayed in the Notification area of the Dashboard.

Health and Maps

The Health dashboard gives you a very high-level overview of cluster, AP and client information. It also displays a world map view using Google Maps, which provides a global view of your SmartZone-controlled wireless network deployments.

The status bar at the top of the Health dashboard contains an iconic representation of the total Cluster, AP and Client counts for the entire system. This information can be filtered to display a single zone, AP group, or venue using the drop-down filter menu. You can also customize the dashboard layout and threshold settings using the Settings (gear) icon.

For more information on customizing the information displayed on the Health dashboard, see [Customizing Health Status Thresholds](#) on page 22.

FIGURE 6 Health Workspace area

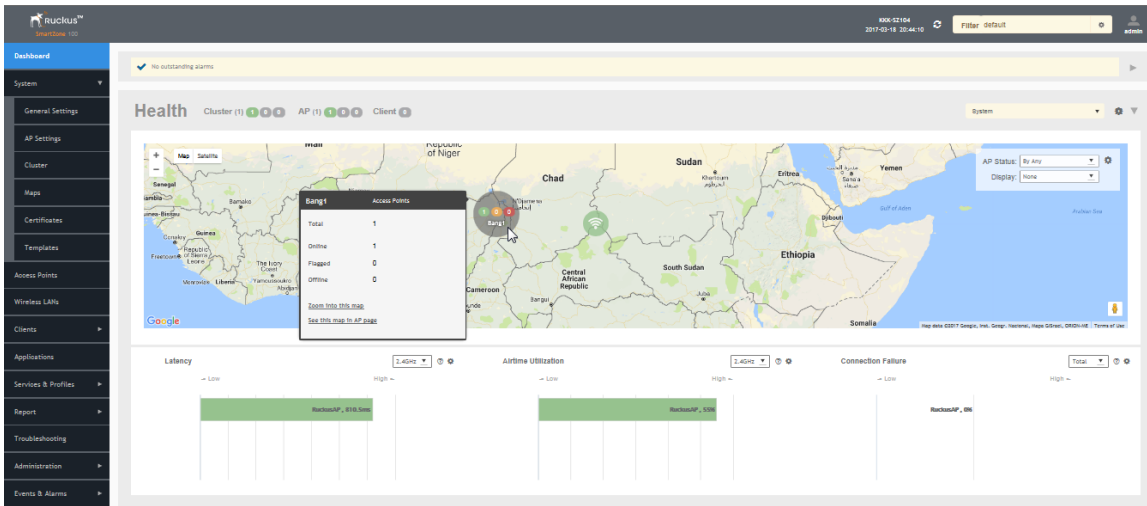

Understanding Cluster and AP Health Icons

The Health dashboard status bar displays the following Cluster and AP information using three colored icons to denote the number of APs/ clusters currently in that state.

The icons for both Cluster and AP status overviews are represented by the following color coding scheme:

- (Green): Online
- (Orange): Flagged
- (Red): Offline

Online and Offline status are self-explanatory. "Flagged" status is user-defined. You can customize the thresholds at which an AP or cluster enters "flagged" state using the **Settings** (gear) icon in the status bar. For more information, see [Customizing Health Status Thresholds](#) on page 22.

Customizing Health Status Thresholds

You can customize the way SmartZone categorizes and displays clusters and APs as "Flagged" in the status bar.

To customize the Health dashboard, click the **Settings** (gear) icon. In the **Settings - Health Dashboard** form, click the **Cluster Status** or **AP Status** tab, and configure the following:

- **Cluster Status:** Configure CPU, hard disk and memory usage percentages above which the cluster will be marked as flagged status.
- **AP Status:** Configure the criteria upon which APs will be flagged. For more information, see [Customizing AP Flagged Status Thresholds](#) on page 23.

FIGURE 7 Setting Cluster Health Status Thresholds

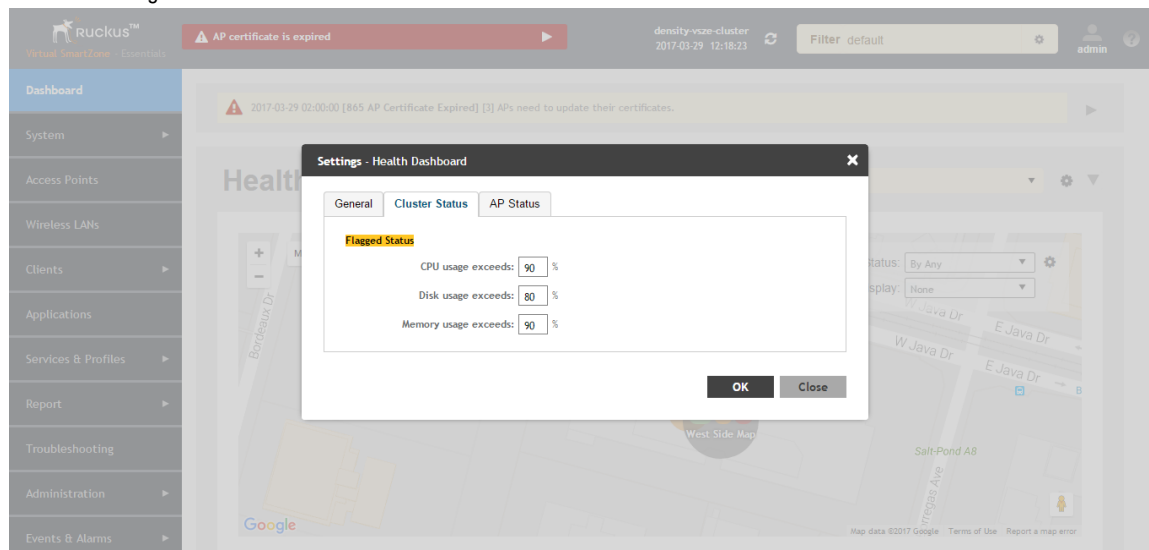

Customizing AP Flagged Status Thresholds

Use the following procedure to customize when APs will be marked as "flagged" on the Health dashboard status bar.

1. Click the **Gear** icon on the **Health** dashboard.
2. The **Settings - Health Dashboard** form appears. Click the **AP Status** tab.
3. Select the behavior of flagging policies when applying changes to parent or child groups:
 - Apply the change to all child groups
 - Apply the change if child group settings already match the parent group
4. Configure thresholds above which APs will be marked as "flagged" for the following criteria:
 - Latency
 - Airtime Utilization
 - Connection Failures
 - Total connected clients
5. Configure the radio (2.4 / 5 GHz) from the drop-down menu and select the level (system, zone, AP group) at which you want to apply the policy, and configure the **Sensitivity** control for the threshold (Low, Medium, High). Setting the Sensitivity level to Low means that an AP must remain above the threshold for a longer period of time before it will appear in the flagged category, while a High sensitivity means that APs will more quickly alternate between flagged and non-flagged status.

- Click **OK** to save your changes.

FIGURE 8 Configuring AP flagged status thresholds

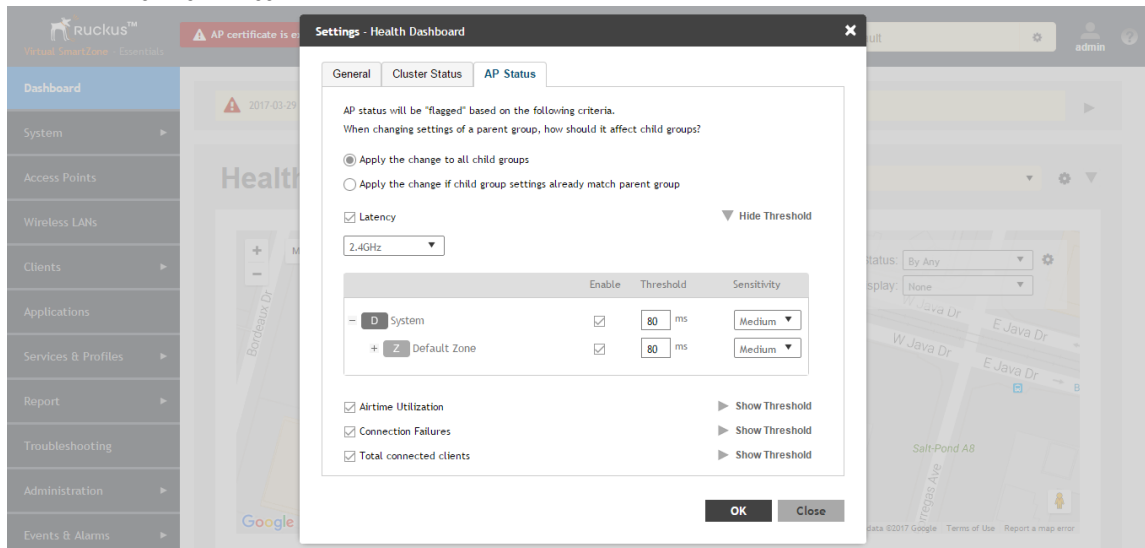

Using the Health Dashboard Map

Use the Google Maps view just as you would normally use Google Maps - including zoom, satellite view, rotate and even street view icons. You can customize the AP icon information displayed on the map using the tools in the upper-right hand corner.

Use the **Settings** (gear) icon to configure the information displayed in tooltips when hovering over an AP on the map. You can also change the view mode altogether, from map view to Groups, Control Planes or Data Planes view mode using the settings menu. Additionally, you can also select the check-box to show mesh links. These links appear as dotted lines. If you hover over the mesh link on the map, a pop-up appears displaying more information such as the following:

- Uplink AP: displays the IP address of the uplink AP to which the wireless client sends data
- Downlink AP: displays the IP address of the downlink AP from which data is sent back to the wireless client
- SNR (Uplink): displays the signal-to-noise ratio in the uplink path
- SNR (Downlink): displays the signal-to-noise ratio in the downlink path
- Bytes (Uplink): displays the bytes of data transferred from the client to the uplink AP
- Bytes (Downlink): displays the bytes of data transferred from the downlink AP to the client
- Connected Since: displays the date and time when the mesh connection was established

Bytes (Uplink) and *Bytes (Downlink)* are aggregate counters for the mesh connection since the start of that mesh connection. If the mesh link is broken and restarts, the counter restarts. If the mesh AP connects to a different mesh root or uplink, the counter restarts.

FIGURE 9 Mesh Link Details

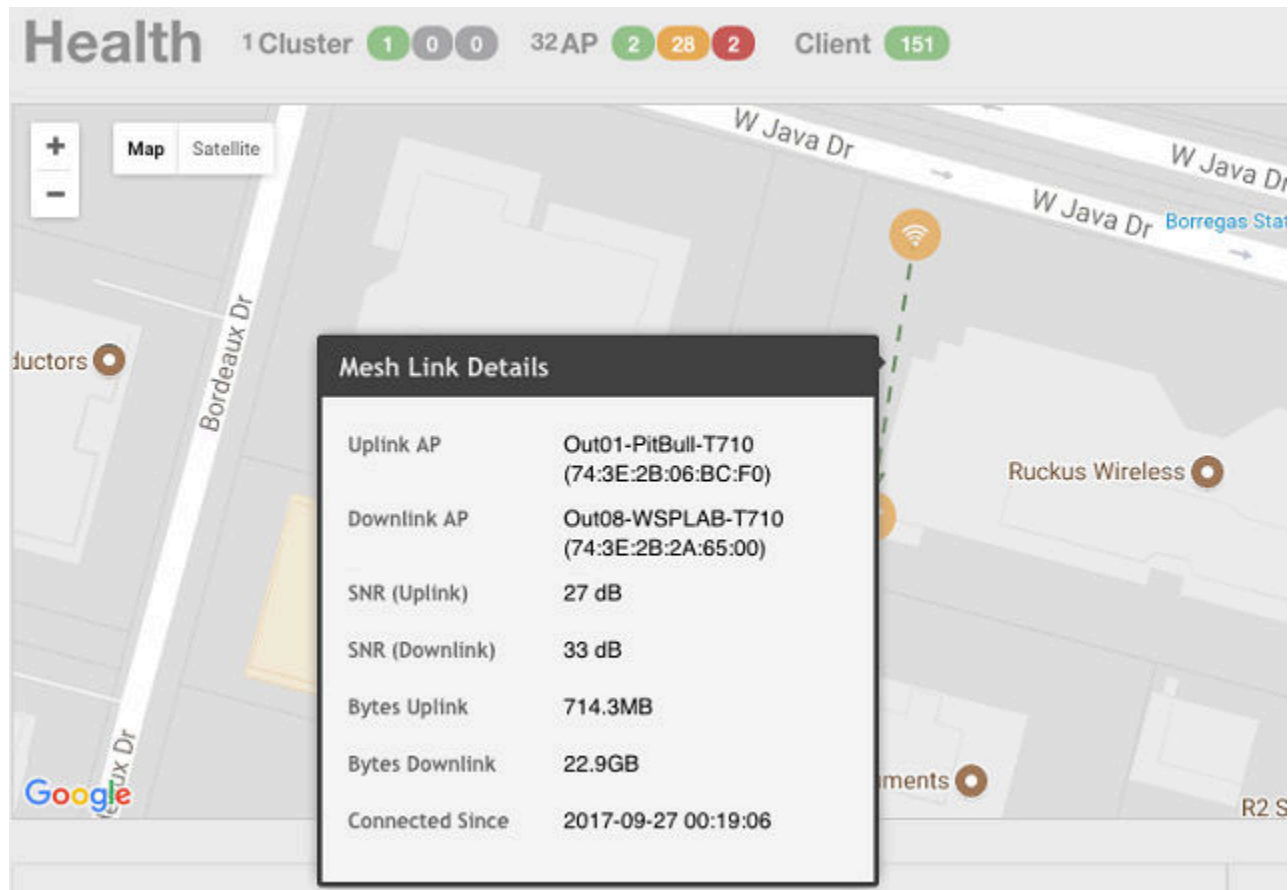

You can also select the Google Map API key to use the Maps service with the application.

FIGURE 10 Configuring map settings

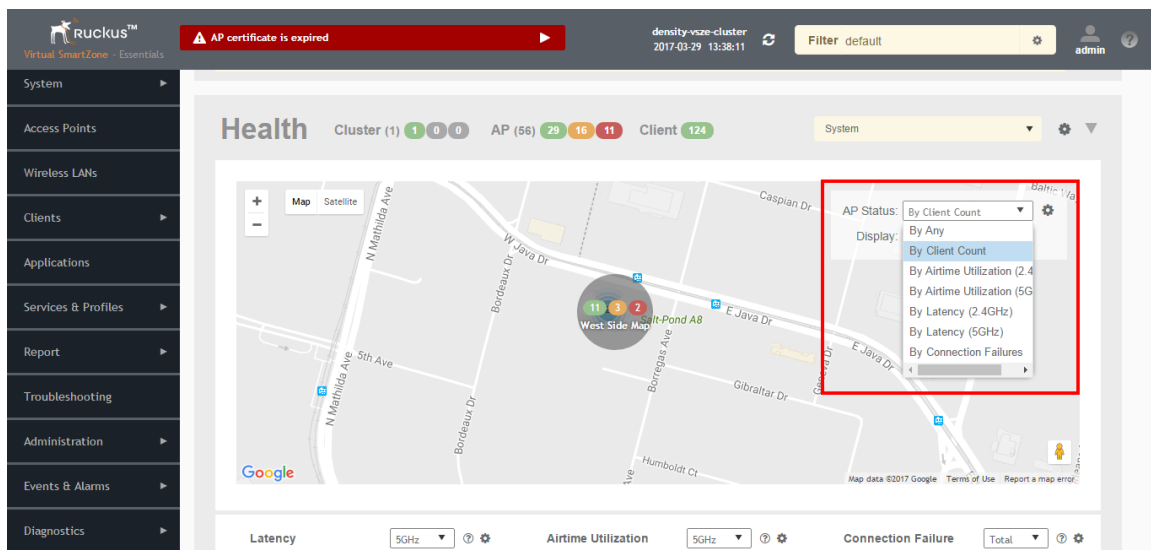

NOTE

In order for your venues to appear on the world map, you must first import a map of your site floorplan.

Configuring the Google Map API Key Behavior

The Google Maps feature in the controller application works based on API interaction between the application and the Maps service hosted by Google. By default, these APIs are commonly available without the need for an API key but sometimes, you might have to generate a key.

If Google Maps do not display properly in the absence of an API key, or when the API usage exceeds the daily limit, then an API key needs to be generated to ensure the map displays all the elements properly.

You would also have to generate an API key if you encounter errors such as

MissingKeyMapError

or

NoApiKeys

FIGURE 11 Health dashboard view when API key is not available

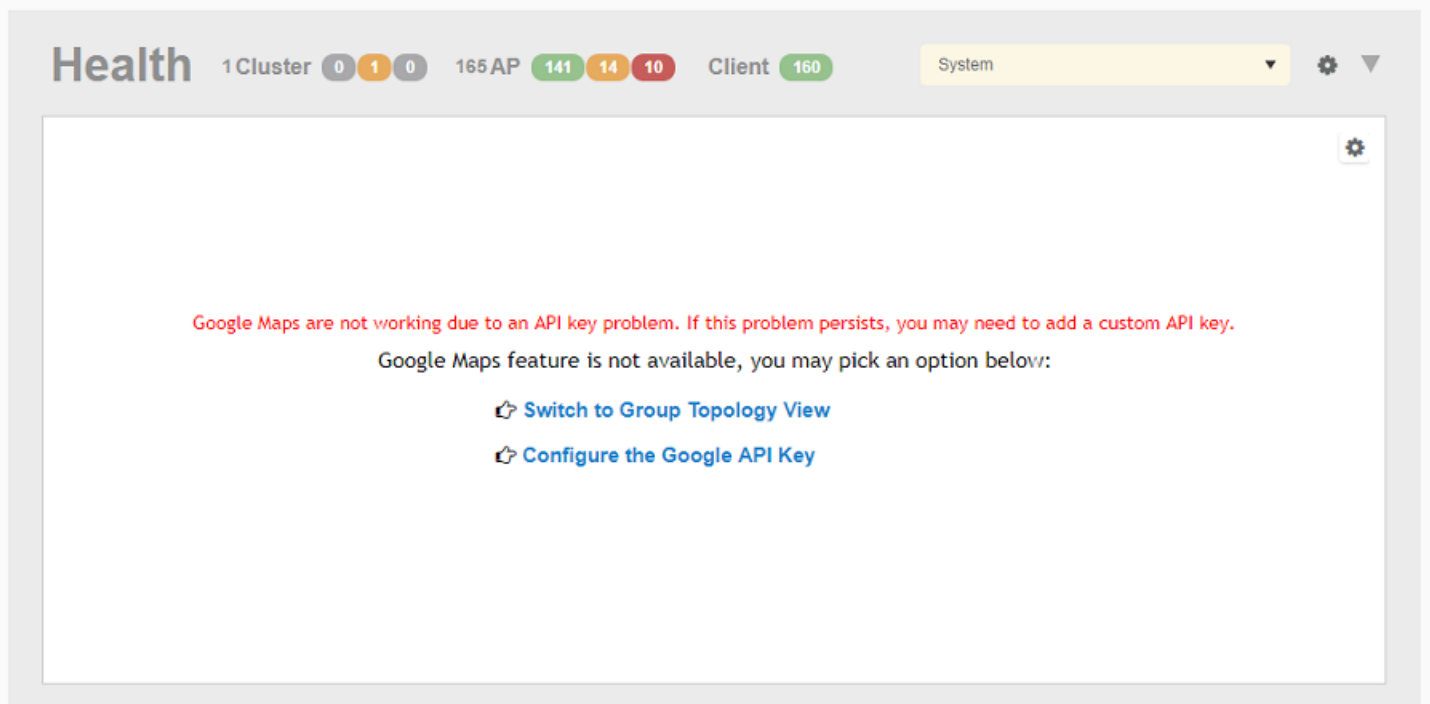

Clicking **Configure the Google API Key** directs you to the **Google Map API Key** tab, where you can manage the Google Map API Key behavior.

All administrators of the system can use the same API key, or apply a unique API key per administrator. Allowing an API key per administrator enables more flexibility when API usage is high, or in circumstances when each tenant must use their own API key.

Follow these steps to configure the Google Map API Key behavior.

Launching the application displays the **Dashboard** menu, by default.

In **Health**, the map view appears if you are connected to a network. If you are not, then you might see the following screen and would have to view your network deployment as a topology diagram.

FIGURE 12 No Map View

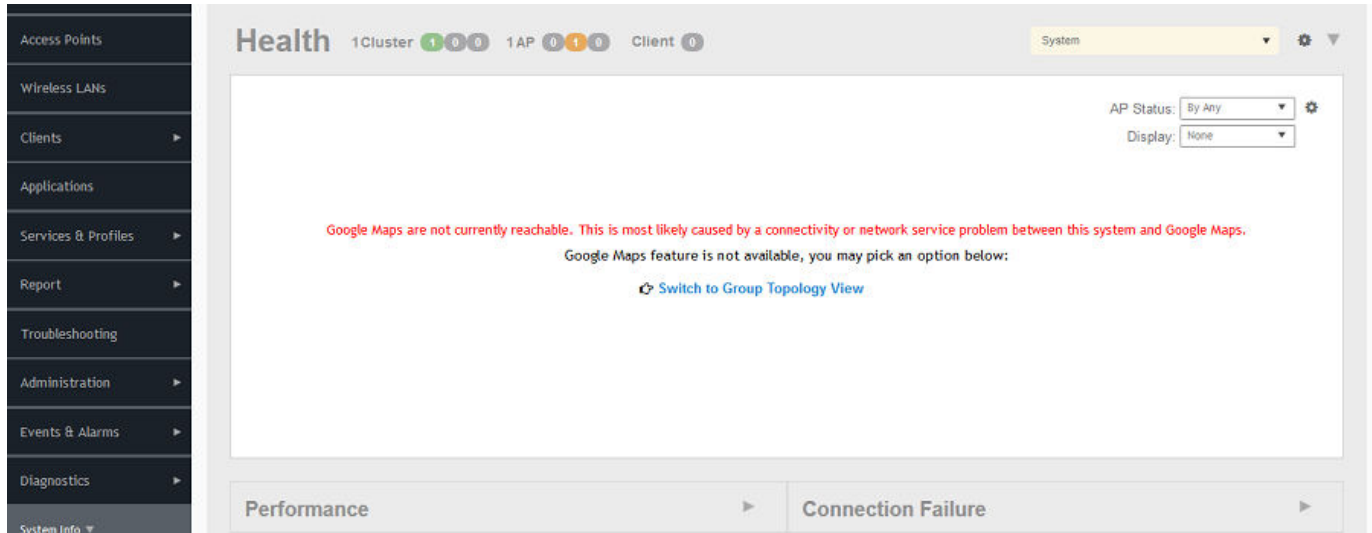

If you click the **Switch to Group Topology View**, a topology diagram similar to the following figure is displayed.

FIGURE 13 Topology View



1. From the map view in **Health**, click the **Settings** (gear-shaped) icon.
The **Settings-Map** page appears.

FIGURE 14 Google Map API Key Options

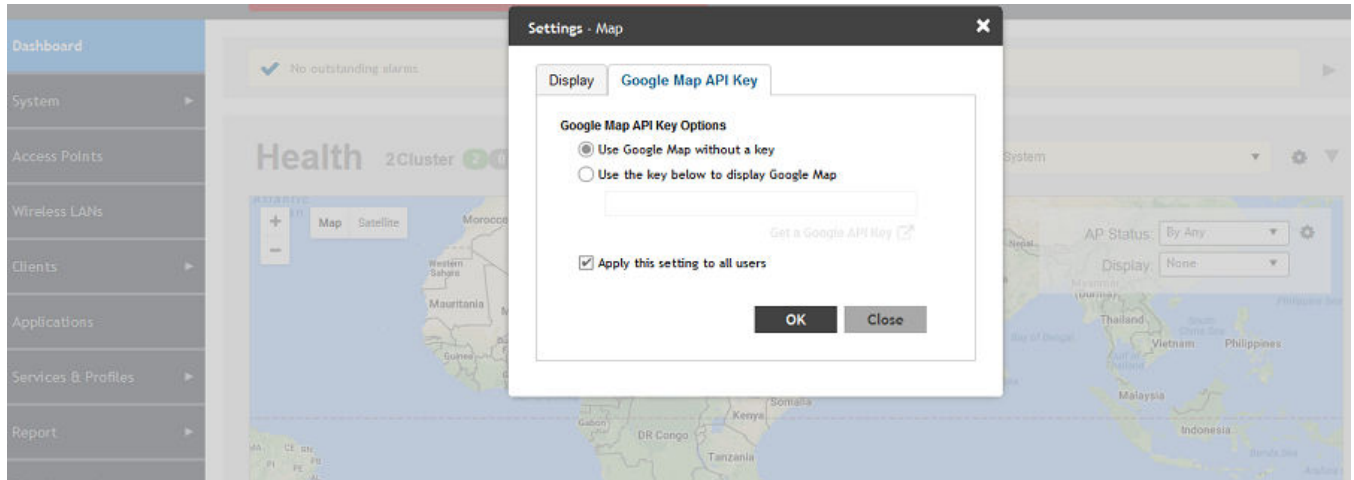

From the **Display** tab, you can choose the mode in which you want to view your network deployment.

2. Click the **Google Map API Key** tab.
3. From the **Google Map API Key Options**, select one of the following:

Option	Description
Use Google Map without a key	Allows you to use the Google map feature without an API key.
Use the key below to display Google Map	Allows you to enter an API key which you already have to use the Google map feature. If you do not have a pre-existing API key, you can generate one by following the instructions in the Get a Google API Key link.

NOTE

The Google API Console is a platform on which you can build, test, and deploy applications. To use Google Maps API, you must register your application on the Google API Console and generate a Google API key which you can add to the application. For more information, see <https://developers.google.com/maps/documentation/javascript/tutorial>

If you already have a Google API Map Key, type the key to establish a connection with Google Maps.

4. Select **Apply this setting to all users** to apply the configuration settings to all users in the network deployment.
5. Click **OK**.

You have successfully configured the Google Map API Key options for your network deployment.

Viewing AP Performance

Click the Performance tab to analyze the following parameters:

- Latency - Average time delay between an AP and connected clients.
- Airtime Utilization - Percent of airtime utilized, by radio.

- Capacity - Measurement of potential data throughput based on the recent air-time efficiency and the performance potential of the AP and its currently connected clients.

You can view the parameters based on specific:

- Duration: 1 hour, 24 hours, 7 days, and 14 days
- Radio: 2.4 GHz, 5GHz

The parameters are displayed as Graphs and Bar Charts. When you hover over the graph you can view the Date and Time, Median, Likely Range, Min-Max Range of the parameters. To view specific information on the graph, click and drag the portion. The selected portion would zoom in. To restore to normal view, click the **Reset zoom** button.

To display specific information, click the settings button. The Settings - Performance window pops up. In **Show top**, enter the number of APs to be analysed and choose the AP identity display.

Viewing AP Connection Failures

Click the Connection Failure tab to analyze the following parameters

- Total - Measurement of unsuccessful connectivity attempts by clients
- Authentication - Measurement of client connection attempts that failed at the 802.11 open authentication stage
- Association - Measurement of client connection attempts that failed at the 802.11 association stage
- EAP - Measurement of client connection attempts that failed during and EAP exchange
- RADIUS - Measurement of RADIUS exchanges that failed due to AAA client/server communication issues or errors
- DHCP - Measurement of failed IP address assignment to client devices

You can view the parameters based on specific:

- Duration: 1 hour, 24 hours, 7 days, and 14 days
- Radio: Total, 2.4 GHz, 5GH

The parameters are displayed as Graphs and Bar Charts. When you hover over the graph you can view the Date and Time, Median, Likely Range, Min-Max Range of the parameters. To view specific information on the graph, click and drag the portion. The selected portion would zoom in. To restore to normal view, click the **Reset zoom** button.

To display specific information, click the Settings button. The Settings - Performance window pops up. In **Show top**, enter the number of APs to be analysed and choose the AP identity display.

Traffic Analysis

You can analyze network traffic for APs, WLANs and clients.

From the traffic analysis tab, you can choose to analyze data using the following filters:

- **Channel Range**
 - Total
 - 2.4GHz
 - 5GHz
- **Throughput**
 - **TX+RX**—Number of bytes sent and received
 - **TX**—Number of bytes sent
 - **RX**—Number of bytes received

- **Group**

The parameters are displayed as Graphs and Bar Charts. When you hover over the graph you can view the Date and Time, Median, Likely Range, Min-Max Range of the parameters. To view specific information on the graph, click and drag the portion. The selected portion would zoom in. To restore to normal view, click the **Reset zoom** button.

Configuring Traffic Analysis Display for APs

Using traffic analysis you can measure the total volume of traffic sent or received by an Access Point (AP).

You can view historical and real-time data of the AP. Throughput and the number of clients connected to the AP are displayed in a bar chart. You must configure the AP settings to view its traffic analysis.

To configure the AP settings:

1. From the Access Points area, click settings . The following window appears.

FIGURE 15 AP Settings Form



Settings - Access Points

Display

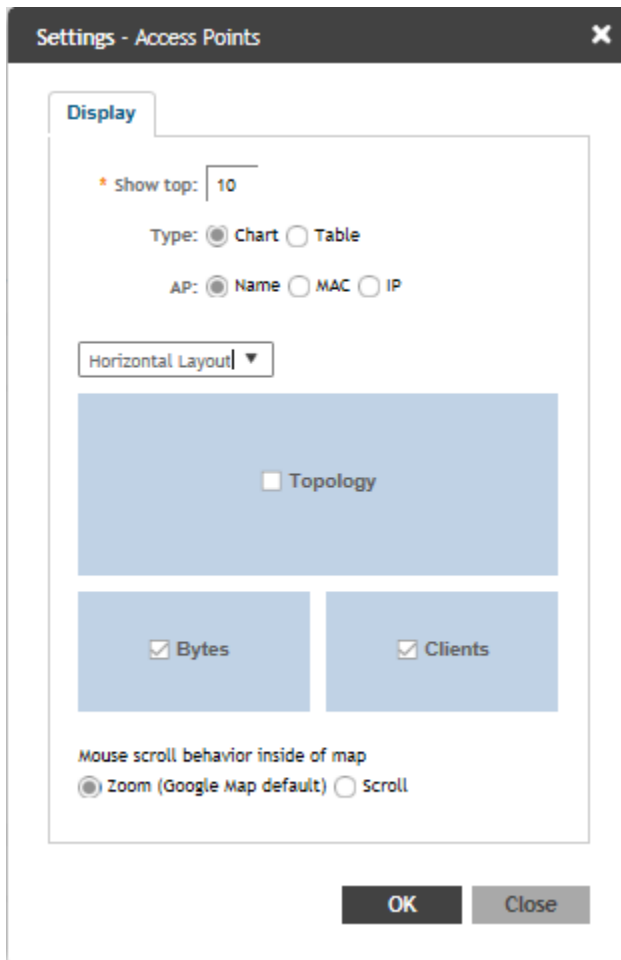
Show top: 10

Type: Chart Table

AP: Name MAC IP

Horizontal Layout

Topology

Bytes Clients

Mouse scroll behavior inside of map

Zoom (Google Map default) Scroll

OK Close

2. In **Show top**, enter the number of APs for which the traffic must be analyzed. Range: 5 through 20.
3. Select the **Type** of display you want to view. For example, **Chart** or **Table**.

4. Select the required **AP** identification option to be displayed. For example, **Name**, **MAC** or **IP**.
5. From the drop-down, select the required display layout. For example, **Horizontal Layout** or **Vertical Layout**.
6. Select or clear the required options that must be displayed in the Content area.
 - **Topology**—To view the location map.
 - **Bytes**—To view the throughput.
 - **Clients**—To view the client details.
7. Select the following mouse-scroll behavior when you point the mouse over a map:
 - **Zoom**
 - **Scroll**
8. Click **OK**.

Configuring Traffic Analysis Display for WLANs

Using traffic analysis you can measure the total volume of traffic sent or received by WLANs.

You can view historical and real-time data of the WLANs. Throughput and the number of clients connected to the WLANs are displayed in a bar chart. You must configure the WLAN settings to view its traffic analysis.

To configure the WLAN settings:

1. From the WLAN area, click settings . The following window appears.

FIGURE 16 WLAN Settings Form

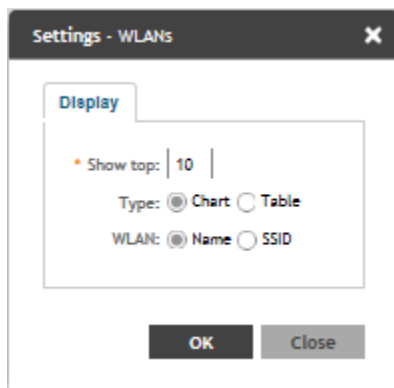

2. In **Show top**, enter the number of WLANs for which the traffic must be analyzed. Range: 5 through 20.
3. Select the **Type** of display you want to view. For example, **Chart** or **Table**.
4. Select the required **WLAN** identification option to be displayed. For example, **Name** or **SSID**.
5. Click **OK**.

Configuring Traffic Analysis Display for Top Clients

Using traffic analysis you can measure the total volume of traffic sent or received by Clients. You can view historical and real-time data of the Clients. The chart displays:

- Bytes—Frequency and number of clients connected to the AP
- OS Type—Types of OS the associated clients are using
- Application—Throughput the applications use

You must configure the Client settings to view its traffic analysis.

To configure the Client settings:

- From the Clients area, click settings . [Figure 17](#) appears.

FIGURE 17 Client Setting Form



- In **Show top**, enter the number of Clients for which the traffic must be analyzed. Range: 5 through 20.
- Select the **Type** of display you want to view. For example, **Chart** or **Table**.
- Select the required **Client** identification option to be displayed. For example, **Name**, **MAC** or **IP**.
- Click **OK**.

Configuring System Settings

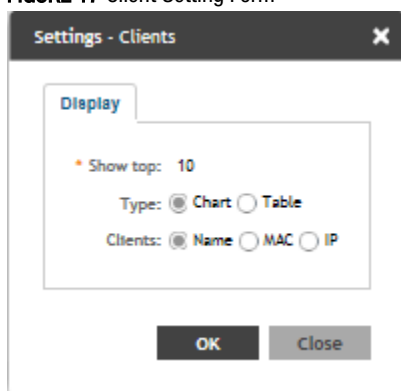
• Configuring General Settings.....	33
• Configuring AP Settings.....	42
• Viewing the System Cluster Overview.....	47
• Working with Maps.....	59
• Certificates.....	63
• Configuring Templates.....	67

Configuring General Settings

Viewing System Settings

You can view the system information such as the controller version, firmware version, license information, control and data plane details from the **General Settings** tab.

To view the system settings, from the left pane, select **System > General Settings > About**. The following system information is displayed:

- Controller Version
- Control Plane Software Version
- Data Plane Software Version
- AP Firmware Version (hover over the field to see the firmware type)
- Cluster Name
- Number of Planes
- System Name
- System Uptime
- Serial Number
- AP Capacity License
- AP Direct Tunnel License

FIGURE 18 General Settings

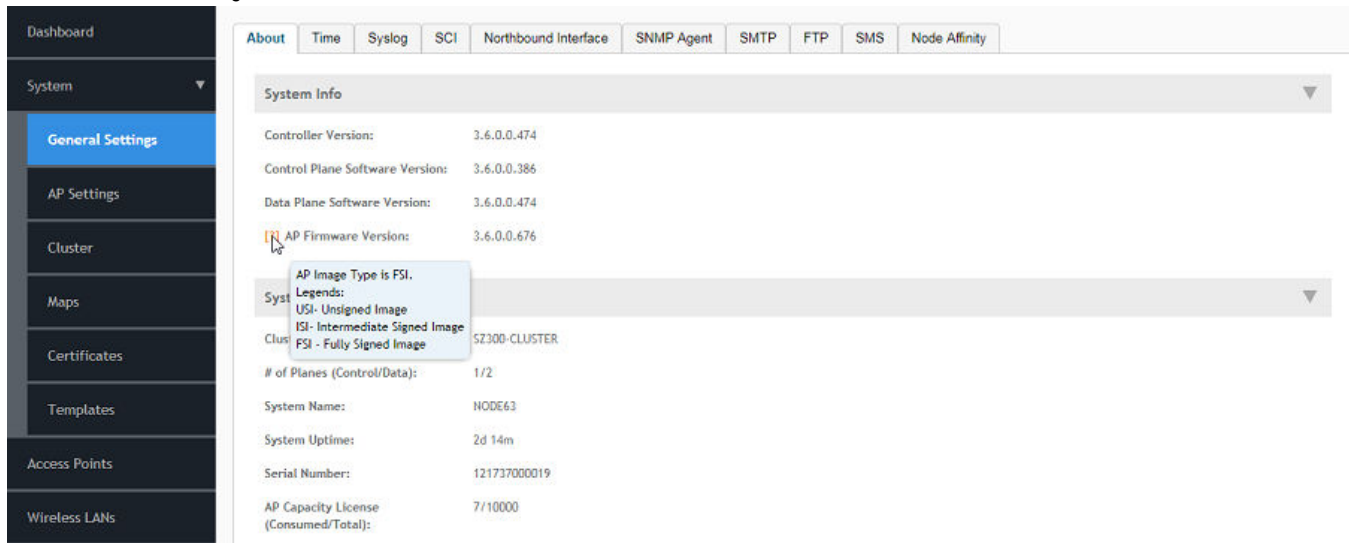

AP image signing involves digitally signing the Ruckus header and body of the AP firmware, and authenticating the firmware as valid to be installed on the AP. AP firmware images are available in the following types:

- *USI*: Un-Signed Images which do not have the capability to sign and verify. It only contains a Header and Body. The Body usually contains both the kernel and file system information.
- *ISI*: Intermediate Signed Image which has the capability to sign and verify, and it allows installation of both signed and unsigned images.
- *FSI*: Fully Signed Image which only allow Ruckus-signed firmware to be installed on the AP. It does not allow installation of unsigned or tampered images.

AP image signing is a two step upgrade or downgrade procedure where in the AP firmware can be upgraded from type USI to ISI, ISI to FSI and vice-versa in the same order.

NOTE

You cannot upgrade an image from USI to FSI as the formats of these images are different. Attempting such an upgrade triggers an **AP image signing failed** event.

Configuring System Time

The controller uses an external network time protocol (NTP) server to synchronize the times across cluster nodes and managed access points.

To edit the system time:

1. Go to **System > General Settings > Time**.
2. Enter the **NTP Server** address that you want to use. The default NTP server address is **ntp.ruckuswireless.com**.
3. Click **Sync Server** to enable an AP to join the controller and automatically synchronize its time every day.
4. Select the **System Time Zone**, from the drop-down that you want the controller to use. The default time zone is (GMT +0:00) UTC.
5. Click **OK**.

Configuring the Remote Syslog Server

The controller maintains an internal log file of current events and alarms, but this internal log file has a fixed capacity. Configure the log settings so you can keep copies of the logs that the controller generates.

At a certain point, the controller will start deleting the oldest entries in log file to make room for newer entries. If you want to keep a permanent record of all alarms and events that the controller generated, you can configure the controller to send the log contents to a syslog server on the network.

Follow these steps to configure the remote syslog server:

1. Go to **System > General Settings > Syslog**.
2. Select the **Enable logging to remote syslog server** check box.
3. Configure the settings as explained in [Table 3](#).
4. Click **OK**.

TABLE 3 Syslog Server Configuration Settings

Field	Description	Your Action
Primary Syslog Server Address	Indicates the syslog server on the network.	<ol style="list-style-type: none"> 1. Enter the server address. 2. Enter the Port number. 3. Choose the Protocol type. 4. Click Ping Syslog Server. If the syslog server is reachable, a flashing green circle and the message Success appears after the button.
Secondary Syslog Server Address	Indicates the backup syslog server on the network, if any, in case the primary syslog server is unavailable.	<ol style="list-style-type: none"> 1. Enter the server address. 2. Enter the Port number. 3. Choose the Protocol type. 4. Click Ping Syslog Server. If the syslog server is reachable, a flashing green circle and the message Success appears after the button.
Application Logs Facility	Indicates the facility for application logs.	<ol style="list-style-type: none"> 1. Select the option from the drop-down. Range: 0 through 7. 2. Select one of the following Filter Severity: <ol style="list-style-type: none"> a. Emerg b. Alert c. Crit d. Error e. Warning f. Notice g. Info h. Debug: Default option
Administrator Activity Logs Facility	Indicates the facility for administrator logs.	<ol style="list-style-type: none"> 1. Select the option from the drop-down. Range: 0 through 7. 2. Select one of the following Filter Severity: <ol style="list-style-type: none"> a. Emerg b. Alert c. Crit d. Error

TABLE 3 Syslog Server Configuration Settings (continued)

Field	Description	Your Action
		e. Warning f. Notice g. Info h. Debug : Default option
Other Logs Filter Severity	Indicates the facility for comprehensive logs.	Select one of the following Filter Severity : 1. Emerg 2. Alert 3. Crit 4. Error 5. Warning 6. Notice 7. Info 8. Debug : Default option
Event Facility	Indicates the facility for event logs.	Select the option from the drop-down. Range: 0 through 7.
Event Filter	Indicates the type of event that must be sent to the syslog server.	Choose the required option: <ul style="list-style-type: none"> • All events — Send all controller events to the syslog server. • All events except client association / disassociation events — Send all controller events (except client association and disassociation events) to the syslog server. • All events above a severity — Send all controller events that are above the event severity to the syslog server.
Event Filter Severity applies to Event Filter > All events above a severity	Indicates the lowest severity level. Events above this severity level will be sent to the syslog server.	Select the option from the drop-down. 1. Critical 2. Major 3. Minor 4. Warning 5. Informational 6. Debug : Default option
Priority	Indicates the event severity to syslog priority mapping in the controller.	Choose the Syslog Priority among Error , Warning , Info and Debug , for the following event severities: <ul style="list-style-type: none"> • Critical • Major • Minor • Warning • Informational • Debug

Configuring SCI Settings

SmartCell Insight uses data from the controller to analyse performance and generate reports about the WiFi network. Configuring the SCI settings in the controller enables data transfer from the controller to the SCI server using the MQTT protocol.

Follow these steps to configure the SCI server settings:

1. Go to **System > General Settings > SCI**.
2. Select the **Enable SCI** check-box to configure the SCI server settings.
3. Click **Create**, the Create SCI Profile form appears.
4. Enter the following details:
 - **Name**—Profile name.
 - **Server Host**—IP address to the SCI host server.
 - **Server Port**—Port number over which the SCI server and controller can communicate and transfer data.
 - **User**—Name for the user.
 - **Password**—password for the respective user.
 - **System ID**—ID of the SCI system that should be accessed.
5. Click **OK**.

NOTE

You can also edit or delete an SCI profile. To do so, select the SCI profile from the list and click **Configure** or **Delete** as required.

Setting the Northbound Portal Password

Third-party applications use the northbound portal interface to authenticate users and to retrieve user information during the UE association.

Follow these steps to configure the northbound portal interface:

1. Go to **System > General Settings > Northbound Interface**.
2. Select **Enable Northbound Interface Support**, and enter the **User Name** and **Password**.
3. Click **OK**.

Enabling Global SNMP Notifications

The controller supports the Simple Network Management Protocol (SNMP v2 and v3), which allows you to query controller information, such as system status, AP list, etc., and to set a number of system settings using a Network Management System (NMS) or SNMP MIB browser.

You can also enable SNMP traps to receive immediate notifications for possible AP and system issues.

The procedure for enabling the internal SNMP agents depends on whether your network is using SNMPv2 or SNMPv3. SNMPv3 mainly provides security enhancements over the earlier version, and therefore requires you to enter authorization passwords and encryption settings, instead of simple clear text community strings.

Both SNMPv2 and SNMPv3 can be enabled at the same time. The SNMPv3 framework provides backward compatibility for SNMPv1 and SNMPv2c management applications so that existing management applications can still be used to manage the controller with SNMPv3 enabled.

Configuring SNMP v2 Agent

To configure SNMP v2 Agent settings:

1. Go to **System > General Settings > SNMP Agent**.
2. Select the **Enable SNMP Notifications Globally** check box to send out notification messages.
3. To configure the SNMPv2 Agent, click **Create** and update the details as explained in the following table.

TABLE 4 SNMP v2 Agent Settings

Field	Description	Your Action
Community	Indicates that applications which send SNMP Get-Requests to the controller (to retrieve information) will need to send this string along with the request before they will be allowed access.	Enter a name.
Privilege	Indicates the privileges granted to this community.	Select the required privileges: <ul style="list-style-type: none"> • Read—Privilege only to read. • Write—Privilege only to read and write. • Notification—Privilege to: <ul style="list-style-type: none"> – Trap—Choose this option to send SNMP trap notification. – Inform—Choose this option to send SNMP notification. <ol style="list-style-type: none"> 1. Enter the Target IP address. 2. Enter the Target Port number. 3. Click Add.

NOTE

You can also edit or delete an SNMPv2 agent. To do so, select the SNMPv2 agent from the list and click **Configure** or **Delete** respectively.

4. Click **OK**.

Configuring SNMP v3 Agent

1. Go to **System > General Settings > SNMP Agent**.
2. Select the **Enable SNMP Notifications Globally** check box to send out notification messages.
3. To configure the SNMPv3 Agent, click **Create** and update the details as explained in the following table.

TABLE 5 SNMPv3 Agent Settings

Field	Description	Your Action
Community	Indicates that applications which send SNMP Get-Requests to the controller (to retrieve information) will need to send this string along with the request before they will be allowed access.	Enter a name.
Authentication	Indicates the authentication method.	Choose the required option: <ul style="list-style-type: none"> • None—Use no authentication. • SHA—Secure Hash Algorithm, message hash function with 160-bit output. <ol style="list-style-type: none"> 1. Enter the Auth Pass Phrase.

TABLE 5 SNMPv3 Agent Settings (continued)

Field	Description	Your Action
		<ol style="list-style-type: none"> 2. Choose the Privacy option. <ul style="list-style-type: none"> – None: Use no privacy method. – DES: Data Encryption Standard, data block cipher. – AES: Advanced Encryption Standard, data block cipher. 3. Enter a Privacy Phrase, 8 through 32 characters. <ul style="list-style-type: none"> • MD5—Message-Digest algorithm 5, message hash function with 128-bit output. <ol style="list-style-type: none"> 1. Enter the Auth Pass Phrase. 2. Choose the Privacy option. <ul style="list-style-type: none"> – None: Use no privacy method. – DES: Data Encryption Standard, data block cipher. – AES: Advanced Encryption Standard, data block cipher. 3. Enter a Privacy Phrase, 8 through 32 characters.
Privilege	Indicates the privileges granted to this community.	<p>Select the required privileges:</p> <ul style="list-style-type: none"> • Read—Privilege only to read. • Write—Privilege only to read and write. • Notification—Privilege to: <ul style="list-style-type: none"> – Trap—Choose this option to send SNMP trap notification. – Inform—Choose this option to send SNMP notification. <ol style="list-style-type: none"> 1. Enter the Target IP address. 2. Enter the Target Port number. 3. Click Add.

NOTE

You can also edit or delete an SNMPv3 agent. To do so, select the SNMPv3 agent from the list and click **Configure** or **Delete** respectively.

4. Click **OK**.

Configuring SMTP Server Settings

If you want to receive copies of the reports that the controller generates or to email guest passes to users, you need to configure the SMTP server settings and the email address from which the controller will send the reports.

Follow these steps to configure the SMTP server settings:

1. Go to **System > General Settings > SMTP**.
2. Select **Enable SMTP Server**.
3. Enter the **Logon Name** or user name provided by your ISP or mail administrator. This might be just the part of your email address before the @ symbol, or it might be your complete email address. If you are using a free email service (such as Hotmail™ or Gmail™), you typically have to type your complete email address.

4. Enter the associated **Password**.
5. For **SMTP Server Host**, enter the full name of the server provided by your ISP or mail administrator. Typically, the SMTP server name is in the format **smtp.company.com**.
6. For **SMTP Server Port**, enter the SMTP port number provided by your ISP or mail administrator. Often, the SMTP port number is **25** or **587**. The default SMTP port value is **25**.
7. For **Mail From**, enter the source email address from which the controller sends email notifications.
8. For **Mail To**, enter the recipient email address to which the controller sends alarm messages. You can send alarm messages to a single email address.
9. Select the **Encryption Options**, if your mail server uses encryption.
 - **TLS**
 - **STARTTLS**Check with your ISP or mail administrator for the correct encryption settings that you need to set.
10. Click **Test**, to verify if the SMTP server settings are correct. The test completed successfully form appears, click **OK**.
11. Click **OK**.

Configuring FTP Server Settings

The controller enables you to automatically back up statistics files, reports, and system configuration backups to an external FTP server. However, before you can do this, you must add at least one FTP server to the controller.

Follow these steps to add an FTP server to which the controller will export data automatically:

1. Go to **System > General Settings > FTP**.
2. Click **Create**, the Create FTP Server form appears.
3. Enter an **FTP Name** that you want to assign to the FTP server that you are adding.
4. Select the required **Protocol**; **FTP** or **SFTP** (Secure FTP) protocol.
5. Enter the **FTP Host**, IP address of the FTP server.
6. Enter the **FTP Port**, number. The default FTP port number is 21.
7. Enter a **User Name** for the FTP account that you want to use.
8. Enter a **Password** that is associated with the FTP user name.
9. For **Remote Directory**, enter the remote FTP server path to which data will be exported from the controller. The path must start with a forward slash (/)
10. To verify that the FTP server settings and logon information are correct, click **Test**. If the server and logon settings are correct, a confirmation message stating, "**FTP server connection established successfully**" appears.
11. Click **OK**.

NOTE

You can edit or delete an existing FTP setting. To do so, select the FTP setting from the list and click **Configure** or **Delete** respectively.

Configuring the SMS Gateway Server

You can define the external gateway services used to distribute guest pass credentials to guests.

To configure an external SMS gateway for the controller:

1. Go to **System > General Settings > SMS**.
2. Select the **Enable Twilio SMS Server** check box to use an existing Twilio account for SMS delivery.
3. Enter the following Twilio Account Information:
 - **Server Name**
 - **Account SID**
 - **Auth Token**
 - **From** (phone number)
4. Click **OK**.

Configuring Node Affinity

Node affinity enables administrators to manually configure the controller nodes to which APs will connect.

To do this, set the order of preferred nodes on the node affinity page. Node affinity is implemented at the AP zone level, which means that all APs that belong to a zone will have the same node affinity settings.

If you want APs that belong to the same zone to connect to the same node whenever possible, you can configure set the preferred node for a particular zone.

NOTE

An affinity profile defines the order of the nodes to which APs that belong to the same zone will connect.

NOTE

Node affinity is not supported on the vSZ-H and vSZ-D platforms.

Enabling Node Affinity

To enable and configure node affinity:

1. Go to **System > General Settings > Node Affinity**.
2. Select **Enable Node Affinity**. Node Affinity Profile appears.
3. To:
 - Create an new profile:
 1. Click **Create**, the Create Node Affinity Profile form appears.
 2. Enter a **Name** and **Description**.
 3. In the **Node Order** list, select the node and click **Up** or **Down** to position the node in the required order.
 4. Click **OK**.
 - Edit the default profile:
 1. Select the profile from the list and click **Configure**. The Edit Node Affinity Profile form appears.
 2. Edit the **Name** and **Description**.
 3. In the **Node Order** list, select the node and click **Up** or **Down** to position the node in the required order.

4. Click **OK**.

NOTE

When you enable node affinity, disable cluster redundancy.

4. To set the number of times an AP will attempt to connect to the preferred node, enter the **# of Node Retry for Preferred Node**.
The default value is 3 and the accepted range is 1 to 10. If the AP is unable to connect to the preferred node, it will attempt to connect to the node that is next in the order of node priority.
5. In the **Zone Assignment** section, set the node affinity profile that you want each zone to use. Select the Zone from the list and click **Assign Profile**. The Assign Node Affinity Profile to Selected Zones form appears.
6. Select the **Node Affinity Profile** from the drop-down and click **OK**.
7. Click **OK**.

Disabling Node Affinity

Follow these steps to disable node affinity:

1. From **System > General Settings > Node Affinity**.
2. Clear the **Enable Node Affinity** check box.
3. Click **OK**. You have disabled node affinity.

Configuring AP Settings

Working with AP Registration Rules

Registration rules enable the controller to assign an AP to an AP zone automatically based on the rule that the AP matches.

NOTE

A registration rule is only applied to an AP the first time it joins the controller. If an AP's MAC address already exists on the controller database (whether it is in connected or disconnected state and whether it belongs to the Staging Zone or any other zone), the controller will assign the AP to its last known AP zone.

This section describes the following tasks:

Creating an AP Registration Rule

You must create rules to register an AP.

To create an AP registration rule:

1. Go to **System > AP Settings > AP Registration**.
2. Click **Create**, the AP Registration Rule form appears.
3. Enter a **Rule Description**.
4. Select the **Zone Name** to which this rule applies.
5. In **Rule Type**, click the basis upon which you want to create the rule. Options include:

NOTE

The format of the IP address or addresses that you need to enter here depends on the AP IP mode that you selected when you created the AP zone to which this rule will be assigned. If you selected IPv4 Only, enter an IPv4 address. If you selected IPv6 Only, enter an IPv6 address.

- **IP Address Range:** If you select this option, enter the From (starting) and To (ending) IP address that you want to use.
- **Subnet:** If you select this option, enter the IP address and subnet mask pair to use for matching.
- **GPS Coordinates:** If you select this option, type the GPS coordinates to use for matching. Access points that have been assigned the same GPS coordinates will be automatically assigned to the AP zone that you will choose in the next step.

You can choose the Rule Type as GPS coordinates, wherein you must provide information about the latitude, longitude and distance to determine if the AP is within the defined area.

- **Provision Tag:** If the access points that are joining the controller have been configured with provision tags, click the Provision Tag option, and then type a tag name in the Provision Tag box. Access points with matching tags will be automatically assigned to the AP zone that you will choose in the next step.

NOTE

Provision tags can be configured on a per-AP basis from the access point's command line interface.

6. Click **OK**.

When the process is complete, the page refreshes, and then registration rule that you created appears on the AP Registration Rules page.

To create another registration rule, repeat the preceding steps. You can create as many registration rules as you need to manage the APs on the network.

NOTE

You can also edit, delete or clone an AP registration rule. To do so, select the rule profile from the list and click **Configure**, **Delete** or **Clone** respectively.

Configuring Registration Rule Priorities

The controller applies registration rules in the same order as they appear in the AP Registration Rules table (highest to lowest priority).

If you want a particular registration rule to have higher priority, you must move it up the table. Once an AP matches a registration rule, the controller assigns the AP to the zone specified in the rule and stops processing the remaining rules.

Follow these steps to configure the registration rule priorities.

1. Go to **System > AP Settings > AP Registration**.
2. Select the rule from the list and click.
 - **Up**—To give a rule higher priority, move it up the table
 - **Down**—To give a rule lower priority, move it down the table
3. Click **Update Priorities** to save your changes.

Creating vSZ-D Zone Affinity

NOTE

(This feature is supported only for vSZ-H controller)

To create a zone affinity:

1. Go to **System > AP Settings > vSZ-D Zone Affinity**.
2. Click **Create**, the Create New vSZ-D Zone Affinity form appears.
3. Enter a **Name** and **Description** for the zone affinity.
4. Click **Create**, the Add vSZ-D form appears.
5. Choose the zone from the drop-down.
6. Click **OK**.

NOTE

This feature is applicable only to vSZ-H platform.

Tagging Critical APs

A critical AP is an AP that exceeds the daily traffic threshold (sum of uplink and downlink) data bytes configured on the controller web interface.

Follow these steps to tag critical APs (APs that exceed the data traffic threshold that you have defined) automatically:

1. Go to **System > AP Settings > Critical AP Tagging**.
2. Select the **Enable Auto Tagging Critical APs** check box.
3. For **Auto Tagging Rules**, select **Daily Traffic Bytes Exceeds Threshold**.
4. For **Rule Threshold**:
 - In the first box, enter the value that you want to set as the traffic threshold. This value will be applied in conjunction with the data unit that you select in the second box.
 - In the second box, select the data unit for the threshold – **MB** for megabytes or **GB** for gigabytes.
5. Click **OK**.

APs that exceed the daily traffic threshold that you specified will appear highlighted on the Access Points page and the Access Point details page. Additionally, the controller will send an SNMP trap to alert you that that an AP has been disconnected.

Configuring the Tunnel UDP Port

The tunnel UDP port is used by all GRE+UDP type tunnels.

To configuring the tunnel UDP port:

1. Go to **System > AP Settings > Tunnel UDP Port**.
2. Enter the **Tunnel UDP Port** number.
3. Click **OK**.

Setting the Country Code

Different countries follow different regulations for radio channel usage.

To ensure that the APs use authorized radio channels:

1. Go to **System > AP Settings > Country Code**.

2. Select the **Country Code** for your location from the drop-down.
3. Click **OK**.

Limiting the Number of APs in a Domain or Zone

You can limit the number of APs in a Partner-Managed Domain or a Zone. An MSP may have multiple customers each with their own zone and a number of APs. This feature ensures that their customers do not over-subscribe the licenses that they are entitled. MVNO domains do not have this option. When an AP joins a zone, where an AP number limitation has been applied to that zone, the controller checks the current capacity based on zone's limitation and:

- allows the new AP joining if the number of APs connected do not exceed the limit
- denies the new AP joining if there is no capacity in the domain or zone.

A scheduler task in the background periodically checks the AP number limitation against the number of APs connected. To avoid occupying the license capacity, the APs will be rejected in the following situations:

- If the AP number limitation of a Domain or a Zone is increased or reduced.
- If the license capacity is changed.

The following image gives a clarity on:

- System domain
- Partner domain
- Zones in a System domain
- Zones in a Partner domain

FIGURE 19 System Hierarchy

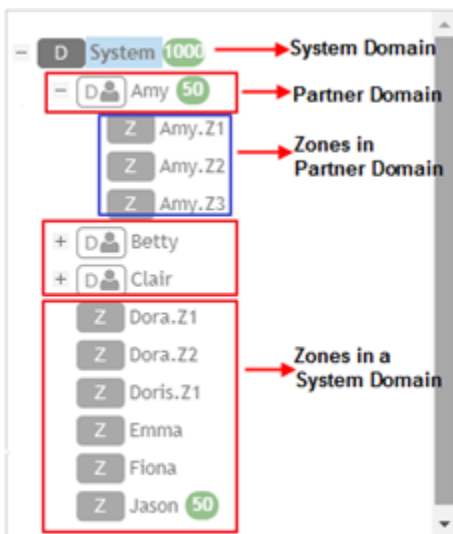

Limiting the AP count for a Partner Domain or a System Zone

Only super admin of the system domain is privileged to limit the number of APs in a partner domain or a system zone.

To limit the number of AP count for a partner domain or a system zone:

1. Log on to the controller web interface using super admin credentials of the system domain.

2. Follow the procedure to limit the number of APs in the partner domain or a zone in system domain:
 - a) Go to **System > AP Settings > AP Number Allocation**.
 - b) For **Enable AP Number Allocation**, select the **Enabled** check box and click **OK**. The Settings bar appears.
 - c) From the left pane, in the system tree hierarchy, select the partner-managed Domain or Zone for which you want to set the AP number limit.
 - d) On the right pane, select **Share Mode** or enter the **Number Limit**.
 - e) Click **OK**. You have set the AP number limit for the selected Domain or Zone.

Limiting the AP count for a Zone in a Partner Domain

Super Admin of the partner domain have the privilege to configure the zones in that domain.

To limit the number of AP count for a zone in a partner domain:

1. Create a super admin account for the partner domain. Refer, [Creating Administrator Accounts](#) on page 272.

2. **NOTE**

While creating user groups, in step 4 (l) c, for **Permission**, select Super Admin from the drop-down.

Create a user group and configure the access permissions, resources and administrator account. Refer, [Creating User Groups](#) on page 271.

3. Log on to the controller web interface using the following logon details:

- **User Name:**

`Account Name@Domain`

The Account Name that you set when you created the Administrator Account and the Domain for which you created the Administrator Account. For example: If the partner domain is *TestDomain* and the Account Name is *User*, then the User Name is

`User@TestDomain`

- **Password** : The password that you set when you created the Administrator Account.

4. Follow the procedure to limit the number of APs for a zone in a partner-domain:
 - a) Go to **System > AP Settings > AP Number Allocation**.
 - b) Select the **Enable AP Number Allocation** check box and click **OK**. The Settings bar appears.
 - c) From the left pane, in the system tree hierarchy, select the partner-managed zone for which you want to set the AP number limit.
 - d) On the right pane, perform one of the following procedure:
 - Select **Share Mode**
 - Enter **Number Limit**
 - e) Click **OK**.

You have set the AP number limit for the selected partner-domain Zone.

Viewing the System Cluster Overview

The system cluster overview provides summary information of the controller cluster.

To view the cluster settings:

- From the left pane of the application, click **System** > **Cluster**. The Cluster page appears.

FIGURE 20 System Cluster Overview

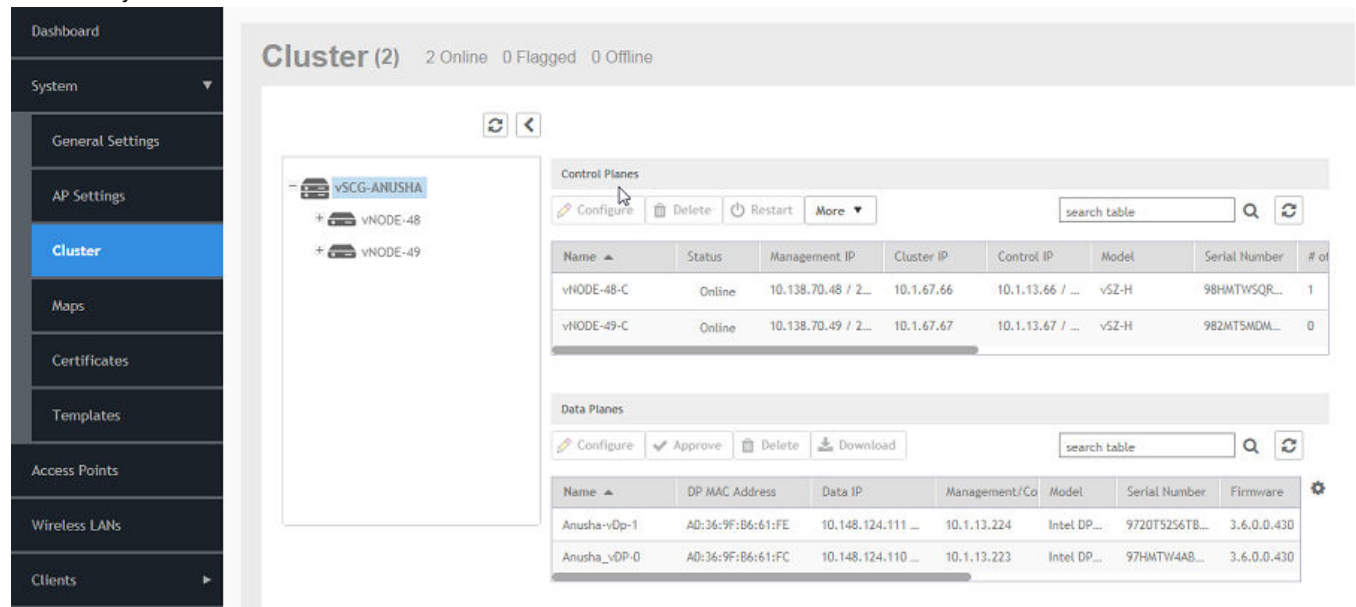

Control Planes and Data Planes

Control planes and data planes are used to control traffic.

The control plane manages and exchanges routing table information. The control plane packets are processed by the router to update the routing table information. The data plane forwards the traffic along the path according to the logic of the control plane.

You can view historical and real time traffic of the nodes. To view the traffic:

- From the Controller page, select the node.
- Click the Traffic & Health from the lower end of the page.
- Select the option from the drop-down:
 - Historical Data**, and enter the timeframe for which you want.
 - Real Time Data**, enter the duration in minutes and click **Start**.

Figure 21 appears.

FIGURE 21 Cluster Node Traffic and Health.

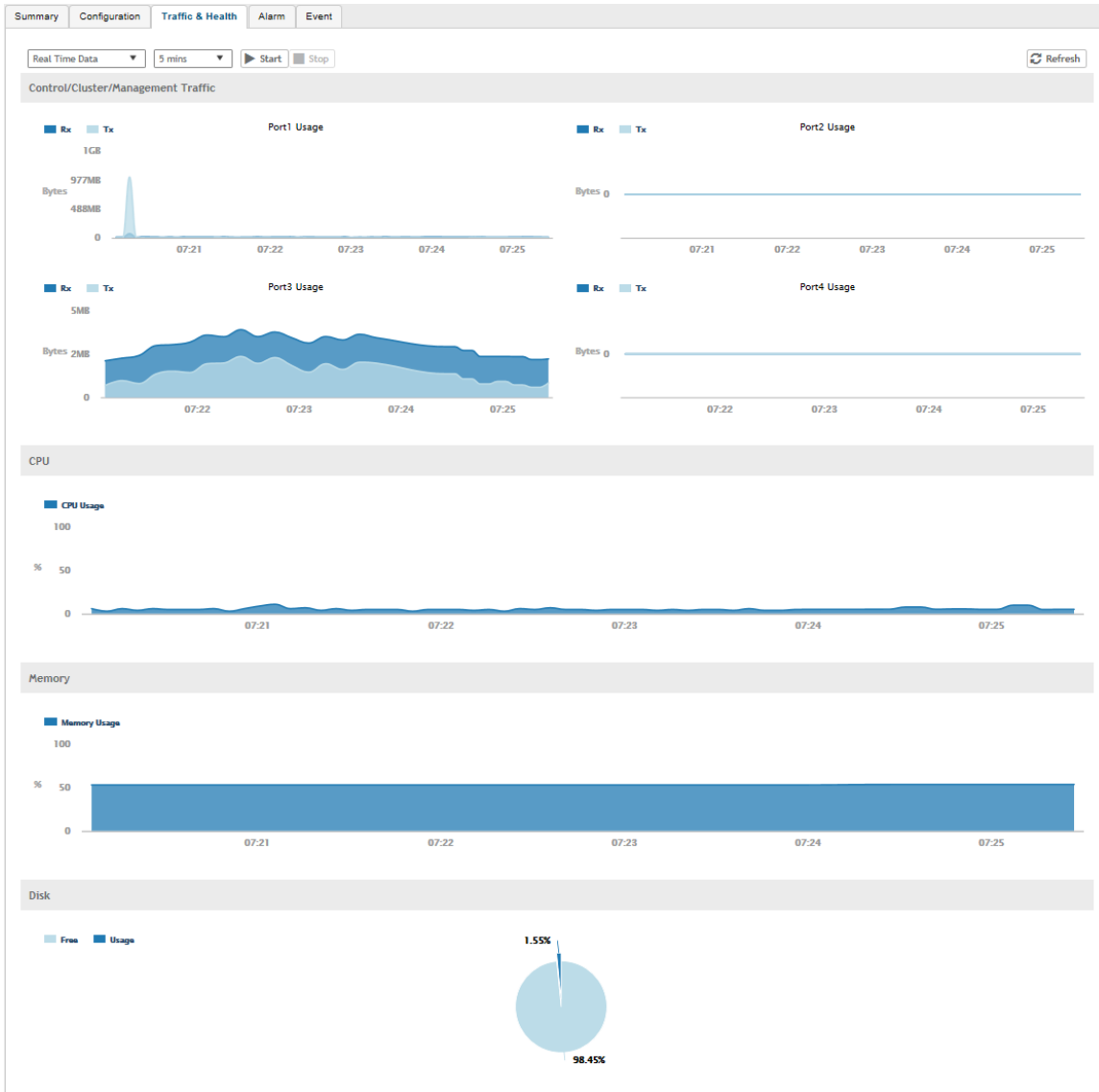

Interface and Routing

To configure a cluster node, you must define interface and routing information.

Interface

You can only create one user defined interface, and it must be for a hotspot service and must use the control interface as its physical interface. The control plane and the UDI must be on different subnets. If the control plane and UDI are on the same subnet, and assigned with the same IP address, APs will be unable to communicate with the control plane. If the control plane and UDI are on the same subnet and assigned different IP addresses, hotspot clients will not be redirected to the logon URL for user authentication.

NOTE

The user defined interface (UDI) is unavailable in Virtual SmartZone (High-Scale and Essentials).

Static Routing

Static routing is used to manually configure routing entry. Static routes are fixed and do not change if the network is changed or reconfigured. Static routing are usually used to maximize efficiency and to provide backups in the event that dynamic routing information fails to be exchanged.

Displaying the Chassis View of Cluster Nodes

The chassis view provides a graphical representation of the control panel (on the front panel of the controller), including the LEDs.

Use the LEDs to check the status of the ports and power supplies on the controller. Fan status is also displayed on the chassis view.

To view the chassis of the cluster node:

1. From the Cluster page, select the node.
2. From the lower-left side of the page, click the **Chassis** tab.

FIGURE 22 Cluster Node Chassis

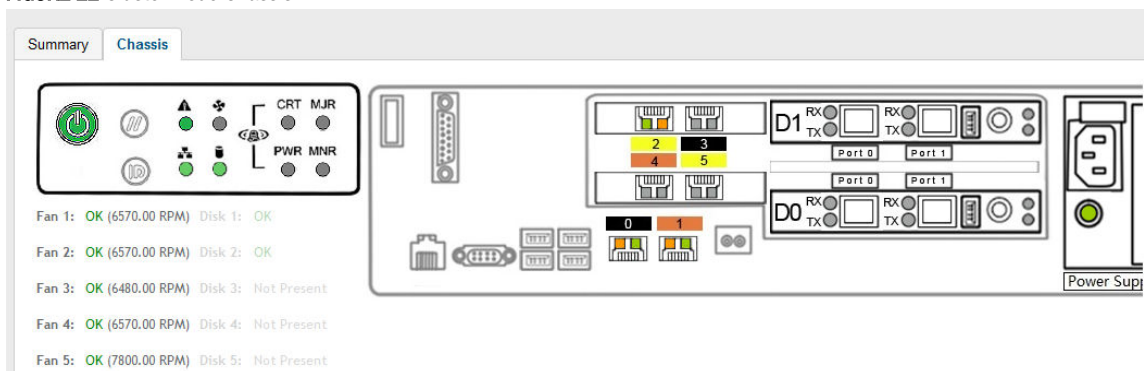

Enabling Cluster Redundancy

If you have multiple clusters on the network, you can configure cluster redundancy to enable APs managed by a particular cluster to fail over automatically to another cluster if their parent cluster goes out of service or becomes unavailable.

NOTE

Cluster redundancy is supported only on SZ300 and vSZ-H.

Active and standby cluster require running exactly same model, IP mode, Interface numbers, KSP and with AP patches/firmwares. The Super admin / System admin, username & password must be the same in the active & standby clusters.

Cluster redundancy can only be enabled on system without authorized external DP. Rehome per domain and zone are not supported. After disabling cluster HA on a standby cluster, update factory settings manually. Once an Active cluster is set to factory default, it can only be made an Active cluster again either by restoring the entire cluster or by enabling cluster redundancy again. Once a Standby cluster is set to factory default, it can only be made as a Standby cluster again either by restoring the cluster or by clicking "Sync Now" on active cluster.

User need to manually sync license on Standby Cluster after it has been set as Standby cluster by active cluster.

Before you configure cluster redundancy, take note of the following:

- Cluster redundancy is disabled by default.
- Only super administrators have the capability to configure the cluster redundancy settings.

FIGURE 23 Cluster Redundancy

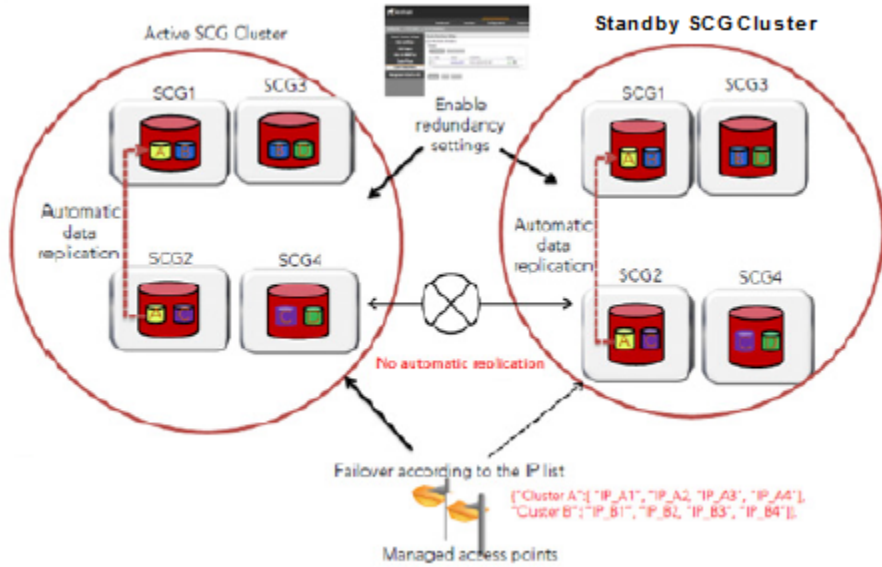

Follow these steps to enable cluster redundancy:

1. Go to **System > Cluster**. The Cluster page appears.
2. Select the cluster, scroll down and click the **Configuration** tab.
3. On the right side of the Configuration area, click **Configure**. The Edit Cluster page appears.
4. In the Cluster Redundancy area, select the **Enable Cluster Redundancy** check box.
5. By default, the **Schedule Configuration Sync** option, appears **Enable**.
6. Select the Sync **Time** in HH:MM format from the drop-down.
7. In the Backup Cluster area, click **Create**. The Standby Cluster form appears.
8. Enter the following External Network details:
 - **Primary Management IP, Port**
 - **Secondary Management IP, Port**. This is optional.
9. Click **OK**. You have enabled cluster redundancy.

NOTE

Once the standby cluster IP / port has been configured, the active cluster starts to sync configuration to the standby cluster.

NOTE

You can also edit the Standby Cluster by selecting **Configure** from the Edit Cluster page.

How Cluster Redundancy Works

The following simplified scenario describes how cluster redundancy works and how managed APs fail over from one controller cluster to another.

1. After you enable and configure cluster redundancy on the controller, managed APs will obtain IPs of all nodes in Active cluster as server list, and all IPs of all nodes in Standby cluster as failover list, which is shown in AP as:

```
{"Server List":["IP_A1", "IP_A2", "IP_A3", "IP_A4"], "Failover List":["IP_B1", "IP_B2", "IP_B3", "IP_B4"]}
```

2. If Cluster A goes out of service or becomes unavailable, APs managed by Cluster A will attempt to connect to the IP addresses (one node at a time) specified for Cluster A.
3. If managed APs are unable to connect to the IP addresses specified for Cluster A, they will attempt to connect to the IP addresses (one node at a time) specified for Cluster B.
4. If managed APs are able to connect to one of the IP address specified for Cluster B, they fail over to Cluster B. APs will move to the zone it belongs to when failover.

NOTE

The standby cluster to which APs fail over must have sufficient license seats to accommodate the new APs that it will be managing. If Standby cluster has insufficient license seats, some APs are unable to get HA license, so can only stay in staging zone in Standby cluster.

Viewing Cluster Configuration

NOTE

Cluster redundancy is supported only on SZ300 and vSZ-H.

Follow these steps to view the cluster configuration:

1. Go to **System > Cluster**. The Cluster page appears.
2. Select the cluster, scroll down and click the **Configuration** tab. You can view the cluster details listed in the following table.

Field	Description
Cluster Configuration	
IP Support	Displays IP support version
Cluster Redundancy	
Status	Displays the cluster redundancy status.
Cluster Redundant Role	Displays the cluster redundancy role.
Active Cluster	Displays name and control IPs of active cluster
Standby Cluster	Displays name, management IPs, and control IPs of standby cluster
Schedule Configuration Sync	<ul style="list-style-type: none"> Status-Displays sync status System Time Zone-Displays the system time zone set Time- Displays the sync time followed everyday Last Trigger Time- Displays the date and time the clusters synced last. Applies to both scheduled sync or manually sync Next Trigger Time- Displays the date and time of the next scheduled sync Sync Now- Triggers manual configuration sync operation

Configuring the Control Plane

Control Plane configuration includes defining the physical interface, user defined interface and static routes.

To configure a control plane:

1. Go to **System > Cluster > Control Planes**.
2. Select the control plane from the list and click **Configure**. The Edit Control Plane Network Settings form appears.
3. Configure the settings as explained in [Table 6](#).

4. Click **OK**.

NOTE

You must configure the **Control** interface, **IPv4 Cluster** interface, and **Management** interface to be on three different subnets. Failure to do so may result in loss of access to the web interface or failure of system functions and services.

TABLE 6 Configuring Control Plane

Field	Description	Your Action
Physical Interfaces		
IPv4-Control Interface	Indicates the management and IP control settings.	<p>Select the IP Mode:</p> <ul style="list-style-type: none"> • Static (<i>recommended</i>)—To manually assign an IP address to this interface manually. <ul style="list-style-type: none"> – Enter the IP Address. – Enter Subnet Mask. – Enter the Gateway router address. – Enter Control NAT IP address. • DHCP—To automatically obtain an IP address from a DHCP server on the network. <ul style="list-style-type: none"> – Enter Control NAT IP.
IPv4-Cluster Interface	Indicates the IPv4 cluster interface settings	<p>Select the IP Mode:</p> <ul style="list-style-type: none"> • Static (<i>recommended</i>)—To manually assign an IP address to this interface manually. <ul style="list-style-type: none"> – Enter the IP Address. – Enter Subnet Mask. – Enter the Gateway router address. • DHCP—To automatically obtain an IP address from a DHCP server on the network.
IPv4-Management Interface	Indicates the IPv4 management interface settings	<p>Select the IP Mode:</p> <ul style="list-style-type: none"> • Static (<i>recommended</i>)—To manually assign an IP address to this interface manually. <ul style="list-style-type: none"> – Enter the IP Address. – Enter Subnet Mask. – Enter the Gateway router address. • DHCP—To automatically obtain an IP address from a DHCP server on the network.
IPv6-Control Interface (This feature is supported only for SZ300 controllers)	Indicates the IPv6 control interface settings	<p>Select the IP Mode:</p> <ul style="list-style-type: none"> • Static (<i>recommended</i>)—To manually assign an IP address to this interface manually. <ul style="list-style-type: none"> – Enter the IPv6 IP Address (global only) with a prefix length (for example, 1234::5678:0:C12/123) is required. Link-local addresses are unsupported.

TABLE 6 Configuring Control Plane (continued)

Field	Description	Your Action
		<ul style="list-style-type: none"> – Enter the IPv6 Gateway address (global or link-local) without a prefix length. For example, 1234::5678:0:C12 (global address without a prefix length) and fe80::5678:0:C12 (link-local address without a prefix length). • Auto— To automatically obtain an IP address from Router Advertisements (RAs) or from a DHCPv6 server on the network.
IPv6-Management Interface (This feature is supported only for SZ300 controllers)	Indicates the IPv6 management interface settings	Select the IP Mode : <ul style="list-style-type: none"> • Static (<i>recommended</i>)— To manually assign an IP address to this interface manually. <ul style="list-style-type: none"> – Enter the IPv6 IP Address (global only) with a prefix length (for example, 1234::5678:0:C12/123) is required. Link-local addresses are unsupported. – Enter the IPv6 Gateway address (global or link-local) without a prefix length. For example, 1234::5678:0:C12 (global address without a prefix length) and fe80::5678:0:C12 (link-local address without a prefix length). • Auto— To automatically obtain an IP address from Router Advertisements (RAs) or from a DHCPv6 server on the network.
Access & Core Separation	Indicates that the management interface (core side) to be the system default gateway and the control interface (access side) to be used only for access traffic.	Select the Enable check box.
IPv4 Default Gateway & DNS	Indicates the IPv4 gateway that you want to use - Control, Cluster, and Management. <p style="text-align: center;">NOTE When Access & Core Separation is enabled, the Default Gateway field is hidden.</p>	<ol style="list-style-type: none"> 1. Default Gateway—Choose the Interface for which you want to assign the default gateway setting. 2. Primary DNS Server—Enter the server details. 3. Secondary DNS Server—Enter the server details.
IPv6 Default Gateway & DNS (This feature is supported only for SZ300 controllers)	Indicates the IPv6 gateway that you want to use - Control, Cluster, and Management. <p style="text-align: center;">NOTE When Access & Core Separation is enabled, the Default Gateway field is hidden.</p>	<ol style="list-style-type: none"> 1. Default Gateway—Choose the Interface for which you want to assign the default gateway setting. 2. Primary DNS Server—Enter the server details. 3. Secondary DNS Server—Enter the server details.
User Defined Interfaces		

TABLE 6 Configuring Control Plane (continued)

Field	Description	Your Action
<p>NOTE The control plane and the UDI must be on different subnets. If the control plane and UDI are on the same subnet, and assigned the same IP address, APs will be unable to communicate with the control plane. If the control plane and UDI are on the same subnet and assigned different IP addresses, hotspot clients will not be redirected to the logon URL for user authentication.</p>		
Name	Indicates the name of the interface.	Enter a name.
Physical Interfaces	Indicates the physical interface.	Select Control Interface .
Service	Indicates the service.	Select Hotspot , the hotspot must use the control interface as its physical interface.
IP Address	Indicates the IP address that you want to assign to this interface.	Enter the IP address.
Subnet Mask	Indicates the subnet mask for the IP address.	Enter the subnet mask.
Gateway	Indicates the IP address of the gateway router.	Enter the gateway IP address.
VLAN	Indicates the VLAN ID that you want to assign to this interface.	Enter the VLAN ID.
Add	Adds the interface settings.	Click Add .
Static Routes		
Network Address	Indicates the destination IP address of this route.	Enter the IP address.
Subnet Mask	Indicates a subnet mask for the IP address.	Enter the subnet mask.
Gateway	Indicates the IP address of the gateway router.	Enter the IP address of the gateway router.
Interface	Indicates the physical interface to use for this route.	Select the interface.
Metric	Represents the number of routers between the network and the destination.	Enter the number of routers.
Add	Adds the static route settings.	Click Add .

NOTE

You can also delete or restart a control plane. To do so, select the control plane from the list and click **Delete** or **Restart** respectively.

Rebalancing APs

AP rebalancing helps distribute the AP load across nodes that exist within a cluster.

When a multi-node cluster is upgraded, the node that reboots the last typically does not have any APs associated with it.

When you click **Rebalance APs**, the following process is triggered:

1. The controller calculates the average AP count based on the number of available control planes and data planes.
2. The controller calculates how many APs and which specific APs must be moved to other nodes to distribute the AP load.
3. The controller regenerates the AP configuration settings based on the calculation result.
4. The web interface displays a message to inform the administrator that the controller has completed its calculations for rebalancing APs.
5. Each AP that needs to be moved to a different node retrieves the updated AP configuration from the controller, reads the control planes and data planes to which it must connect, and then connects to them.

When the AP rebalancing process is complete, which typically takes 15 minutes, one of the following events is generated:

- **Event 770: Generate ApConfig for plane load rebalance succeeded.**
- **Event 771: Generate ApConfig for plane load rebalance failed.**

NOTE

- APs may recreate the Ruckus-GRE tunnel to a different data plane.
- Devices associated with an AP that uses the Ruckus-GRE tunnel may temporarily lose network connection for a short period of time (typically, around five minutes) during the AP rebalancing process.
- When node affinity is enabled, AP rebalancing is disallowed on those nodes.
- When data plane grouping is enabled, AP rebalancing is disallowed on those data planes.
- AP rebalancing only supports APs running release 3.2 firmware. APs running on legacy firmware will not be rebalanced.

To rebalance APs across the nodes:

1. Go to **System > Cluster > Control Planes > More > Rebalance APs**.

FIGURE 24 AP Rebalancing Form

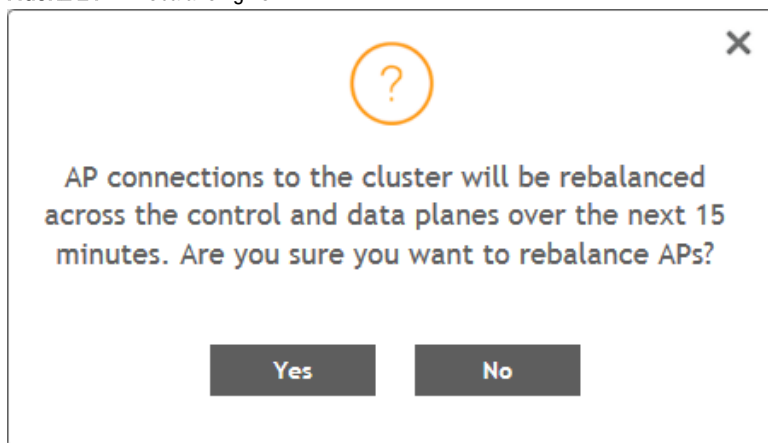

2. Click **Yes**, the controller rebalances AP connections across the nodes over the next 15 minutes.

NOTE

If you want to repeat this procedure, you must wait 30 minutes before the controller will allow you to rebalance APs again.

Configuring the Data Plane

By default, the controller sends traffic from its data plane from a single interface.

NOTE

(This feature is supported only in SZ300 and vSZ-H controllers)

If your organization's network requires separation of the access and core traffic, configure access and core separation on the controller.

To configure a data plane:

1. Go to **System > Cluster > Data Planes**.

2. Select the data plane from the list and click **Configure**. The Edit Data Plane Network Settings form appears.
3. Configure the settings as explained in [Table 7](#).
4. Click **OK**.

TABLE 7 Configuring Data Plane

Field	Description	Your Action
Network		
Interface Mode		
Interface Mode	Indicates the traffic direction.	<p>Choose the option:</p> <ul style="list-style-type: none"> • Single Interface (default)—For the controller to send traffic from its data plane from a single interface. • Access and Core Interface—For the controller to send traffic to the access and core networks separately. <p>NOTE To separate the access and core networks</p> <ul style="list-style-type: none"> – Use static routes, if the data plane is required to connect to IP addresses in the core network (for example, for DHCP relay or L2oGRE termination) and the destination IP addresses are not part of the core subnet. – For SCG-200, there are no predefined access and core interfaces. You can use either ports on the rear panel of the controller to connect to the access network and core network. <ul style="list-style-type: none"> • Keep original configuration—For the controller to keep the original manual Data Plane setup.
Network > Primary (Access) Interface		
IP Mode	Indicates the mode of assigning the IP address to this interface.	<p>Select the option:</p> <ul style="list-style-type: none"> • Static (<i>recommended</i>)—To manually assign an IP address to this interface manually. <ul style="list-style-type: none"> – Enter the IP Address. – Enter Subnet Mask for the IP address. – Enter the Gateway router address. – Enter the Primary DNS Server IP address. – Enter the Secondary DNS Server IP address. – Enter VLAN ID to tag traffic. – Enter Data NAT IP address. • DHCP—To automatically obtain an IP address from a DHCP server on the network. <ul style="list-style-type: none"> – Enter VLAN ID to tag traffic. – Enter Data NAT IP address.
Network > IPv6 Primary (Access) Interface		
IP Mode	Indicates the mode of assigning the IP address to this interface.	<p>Select the option:</p> <ul style="list-style-type: none"> • Static (<i>recommended</i>)—To manually assign an IP address to this interface manually. <ul style="list-style-type: none"> – Enter the IP Address. – Enter the Gateway router address. – Enter the Primary DNS Server IP address. – Enter the Secondary DNS Server IP address.

TABLE 7 Configuring Data Plane (continued)

Field	Description	Your Action
		<ul style="list-style-type: none"> • Auto—To automatically obtain an IP address from a DHCP server on the network.
Network > Secondary (Core) Interface (applicable for Interface Mode: Access and Core Interfaces)		
IP Address	Indicates the IP address of the core network interface.	Enter the IP address. NOTE The secondary/core interface IP address must be configured manually; DHCP is unsupported.
Subnet Mask	Indicates the IP address of the subnet mask.	Enter the subnet mask.
VLAN	Indicates that the traffic is tagged with a VLAN ID.	Enter the VLAN ID. NOTE If VLANs are configured on both the access and core networks, the VLAN ID that you enter here must be different from the one that you entered for the primary/access interface. NOTE You cannot configure the IP address and VLAN settings for a virtual Data Plane from the Primary (Access) and Secondary (Core) Interface sections. Only vSZ-H supports virtual Data Plane.
Disconnect AP when core link down	Indicates that the AP is disconnected secondary core link is down.	Select the check box.
Static Routes		
Network Address	Indicates the destination IP address of this route.	Enter the IP address.
Subnet Mask	Indicates a subnet mask for the IP address.	Enter the subnet mask.
Gateway	Indicates the IP address of the gateway router.	Enter the IP address of the gateway router.
Add	Adds the static route settings.	Click Add .
CALEA Relay		
Mark this Data Plane as CALEA Relay (This feature is supported only for vSZ-E and vSZ-H controllers)	Indicates that the data plane uses CALEA relay.	Select the check box.
DHCP Profile		
DHCP Profile	Indicates the data plane DHCP service profile.	Choose the DHCP service profile from the drop-down.
NAT Profile		
NAT Profile	Indicates the data plane NAT service profile.	Choose the NAT service profile from the drop-down.
Syslog		
Enable DHCP syslog	Enables syslog to record the DHCP logs.	Select the check box.
Enable NAT syslog	Enables syslog to record the NAT logs.	Select the check box.
Syslog Server IP	Indicates the IP address of the remote syslog server.	Enter the IP address of the remote syslog server.

TABLE 7 Configuring Data Plane (continued)

Field	Description	Your Action
Syslog Server Port	Indicates the port number of the remote syslog server.	Enter the Port number of the remote syslog server.

NOTE

You can restart a data plane. To do so, select the data plane from the list and click **Restart**.

Monitoring Cluster Settings

This section provides information on how to view the status of the cluster settings.

You can select the following tabs for more information:

- **Summary**—Details such as Name, model, IP details, memory usage, disk usage.
- **Network Settings**—Details such as control interface, cluster interface, management interface, DNS Server, Routes.
- **Configuration**—Details such as physical interfaces, User defined interfaces, Static Routes Interface.
- **Traffic & Health**—Details such as CPU usage, memory usage, disk usage, interface, port usage.
- **Alarm**—Details of alarms generated. You can Clear Alarm or Acknowledge Alarm that are generated.
- **Event**—Details of events that are generated.

Clearing or Acknowledging Alarms

You can clear or acknowledge an alarm.

To Clear an alarm:

1. From the **Alarm** tab, select the alarm from the list.
2. Click **Clear Alarm**, the Clear Alarm form appears.
3. Enter a comment and click **Apply**.

To acknowledge an alarm:

1. From the **Alarm** tab, select the alarm from the list.
2. Click **Acknowledge Alarm**, the Are you sure you want to acknowledge the selected form appears.
3. Click **Yes**.

Filtering Events

You can view a list of events by severity or date and time.

To apply filters:

1. From the **Event** tab, select the  icon. The Apply Filters form appears.
2. Select any or both the following criteria:
 - **Severity**: Select the severity level by which you want to filter the list of events.
 - **Date and Time**: Select the events by their **Start** and **End** dates.

NOTE

You can filter events that generated in the last seven days.

3. Click **OK**, all the events that meet the filter criteria are displayed on the Event page.

Working with Maps

Importing floorplan maps into SmartZone allows you to further customize the information displayed on the Dashboard and Access Points pages, and monitor your APs, zones, groups, clients and traffic statistics all within the world map view on the Dashboard.

Additionally, you can use the maps to quickly locate more specific information on a venue or zone, and drag and drop APs onto the floor plan map to represent their locations in physical space in your venue.

Once a map is imported and GPS coordinates are entered, an icon representing the venue appears on the world map on the Dashboard. The icon displays the current number of APs (Online, Flagged and Offline). You can hover over the icon for more information.

Double-click the map icon or click **Zoom into this map** to view the imported map in the Dashboard.

FIGURE 25 Once a floorplan map has been imported (with GPS coordinates), it is displayed on the world map on the Dashboard. Hover over the local map icon for

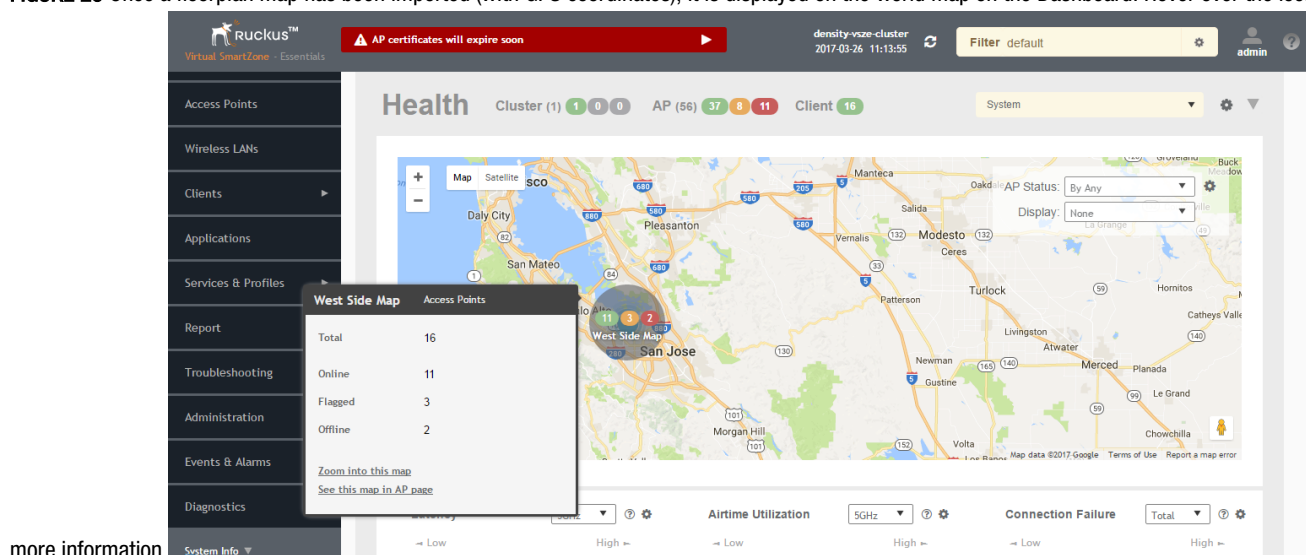

Importing a Floorplan Map

SmartZone provides a user-friendly workflow for importing a map of your venue floorplan, placing APs in their respective physical locations on the map, and scaling the map to match the actual dimensions of your venue.

Floorplan maps allow you to view site/venue/floor-specific details such as:

- AP status, performance, and health conditions
- Client connections to an AP
- Location-specific trouble spots related to AP or client connectivity

To import a floorplan map:

1. Go to **System > Maps**.
2. From the System tree hierarchy, select the location where you want to create a map and click the add **+** button. The **Add Map** form appears.
3. On the **Details** tab, enter a **Name** and optionally a **Description** to identify the map.

Configuring System Settings

Working with Maps

4. Enter a **Location** for the map. Alternatively, you can choose the location from the auto-completion options. Once you select the location, the GPS Coordinates are automatically updated.
5. For **GPS Coordinates**, you can enter the **Latitude** and **Longitude** values.

FIGURE 26 The Add Map form

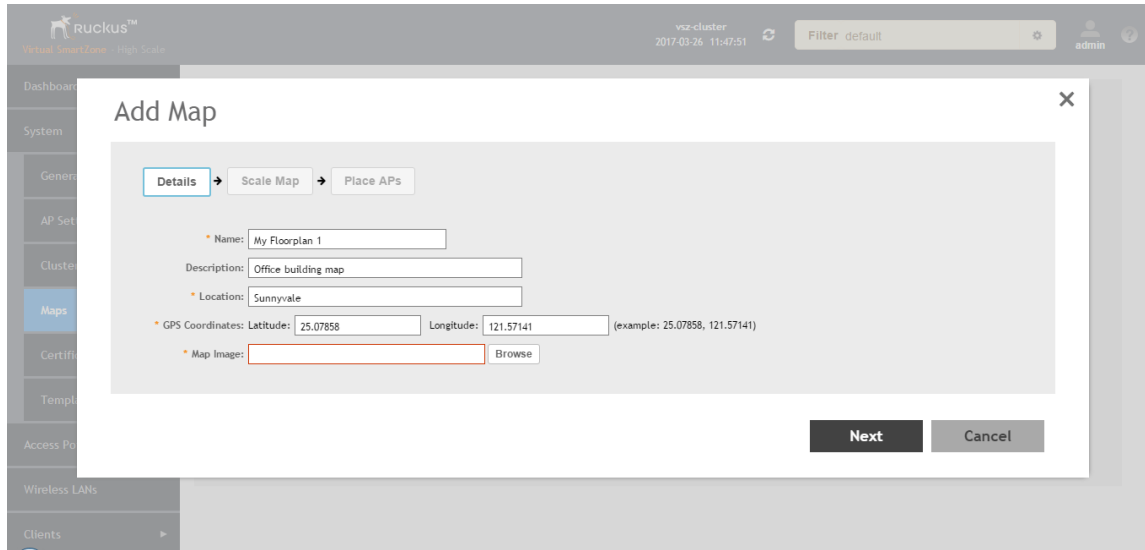

6. To add a **Map Image**, click **Browse** and select a site, venue, or floor map in jpg, jpeg, png, bmp or svg file formats.

NOTE

The maximum file size per indoor map is 5MB.

7. Click **Next**, the **Scale Map** tab appears.
8. Click two points on the map between which you know the distance. Blue dots appear to show the points you selected.

FIGURE 27 Click two points on the map to define the map's scale

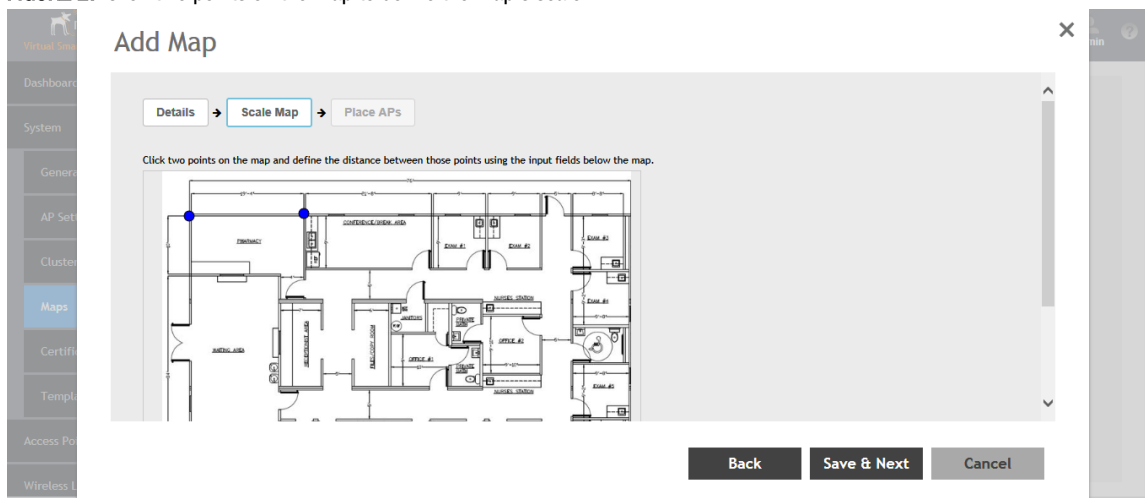

9. Enter the **Physical Distance** between the two points and select the unit of measurement (mm, cm, m, ft, yard).
10. Click **Save & Next**. The **Place APs** tab appears.

- From the **Available** list, drag the APs and place them in their physical locations on the map. Click the **Placed** tab to see the list of placed APs.

FIGURE 28 Drag and drop to place APs onto your floorplan

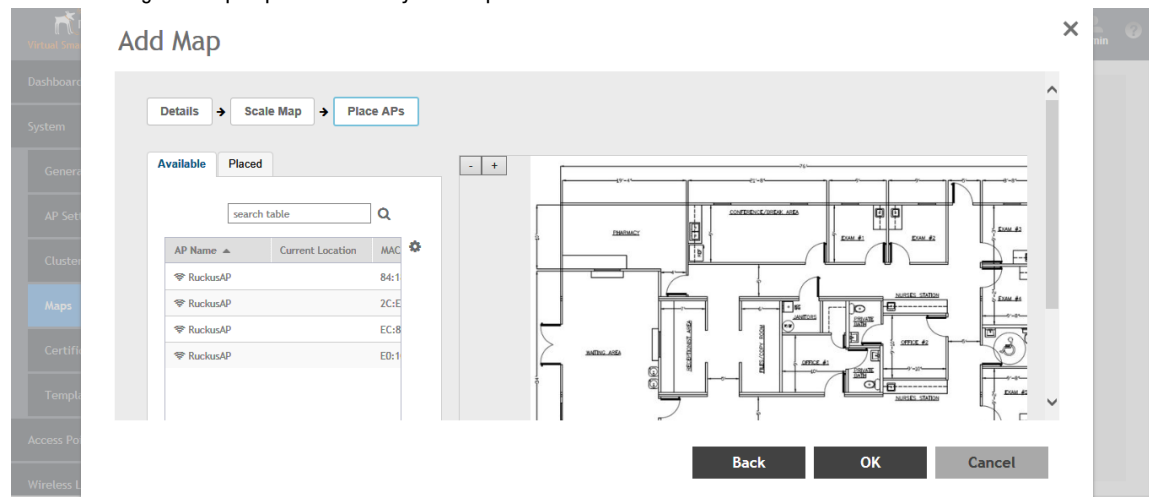

- Once you are happy with the placement of your APs on the map, click **OK** to save your map.

Your venue now appears as an icon on the world map on the Dashboard, located at your venue's actual physical location (if you entered the GPS coordinates correctly). The Dashboard icon that represents your venue provides an overview of the number of APs in the venue and their status. Hover over the icon to view more details, or click one of the links to zoom in to the venue floorplan map you imported.

FIGURE 29 The imported venue map icon appears at the GPS coordinates you configured

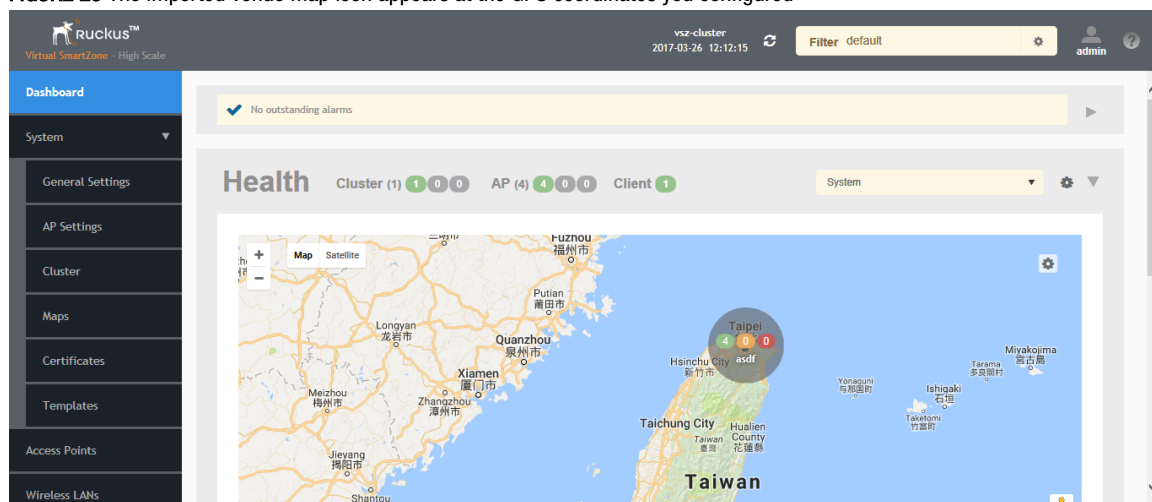

NOTE

You can also edit or delete a map. To do so, select the map from the list and click the **Edit** or **Delete** buttons respectively.

Viewing RF Signal Strength

The heat map helps us identify the RF signal strength in a specific location. It provides heatmaps using actual path loss information from the environment. You can view indoor floor plan map for an AP.

To view the RF signal strength:

1. Go to **System > Maps**.
2. From the System tree hierarchy, select the location of the map that you want to view.
3. Select the **Show Signal Coverage** check box and choose the required RF frequency. For example, 2.4 GHz or 5 GHz. The heat map is displayed with a color-gradient legend. High signal strength appears in red. The color changes as the signal strength reduces.

FIGURE 30 RF Coverage Heat Map

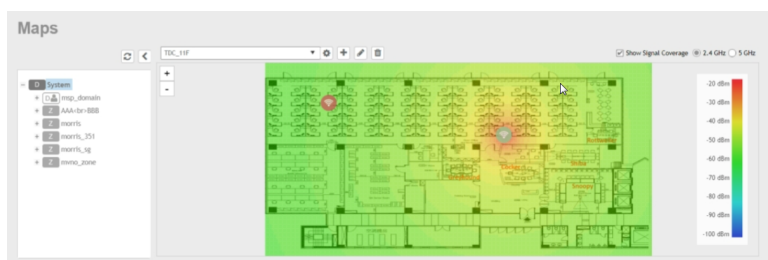

Monitoring APs Using the Map View

Use the Map view on the **Access Points** page to monitor APs in relation to your venue's floorplan.

1. Go to **Access Points**.
2. In **View Mode**, click the **Map** button. The map view is displayed with your placed APs.

3. Hover over an AP to view the following AP-specific details:
 - **AP Name:** The name of the AP, if configured. If not, the default AP name is "RuckusAP."
 - **IP Address:** The current IPv4 or IPv6 address assigned to the AP.
 - **Channel:** Displays the channel (2.4 GHz / 5 GHz) in use, along with the channel width in parentheses.
 - **Clients:** The number of currently connected wireless clients.
 - **Traffic:** The total traffic volume over the last 1 hour.
 - **Latency:** The average time delay between AP and connected clients.
 - **Airtime Utilization:** Percent of airtime utilized, by radio.
 - **Connection Failure:** Percent of client connection attempt failures.

FIGURE 31 Hover over an AP to view details

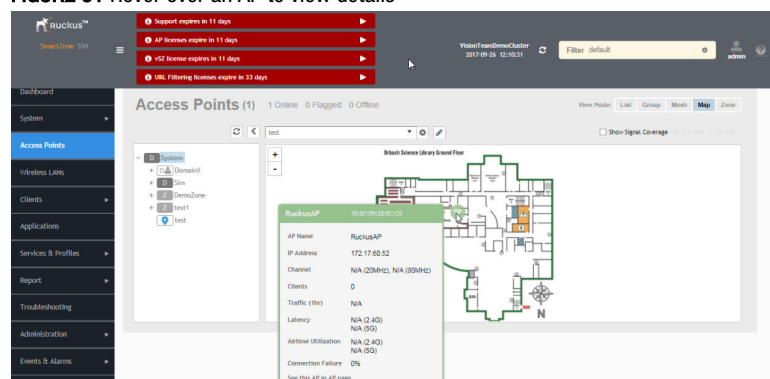

4. To view more specific details on the AP, click the **See this AP in AP page** link.
5. To view the RF signal strength, select the **Show Signal Coverage** check box and choose the required RF frequency. For example, 2.4 GHz or 5 GHz.

The heat map is displayed with a color-gradient legend. High signal strength appears in red. The color changes as the signal strength reduces.

Certificates

All the security certificates that the controller uses for its web interface, AP portal, and hotspots are managed from a central storage.

By default, a Ruckus Wireless-signed SSL certificate (or security certificate) exists in the controller. However, because this default certificate is signed by Ruckus Wireless and is not recognized by most web browsers, a security warning appears whenever you connect to the web interface or users connect to the AP portal or a hotspot. To prevent these security warnings from appearing, you can import an SSL certificate that is issued by a recognized certificate authority.

If you are implementing Hotspot 2.0 on the network and you want to support anonymous authentication using OSU Server-Only Authenticated L2 Encryption Network (OSEN), you will need to import a trust root certificate, server or intermediate certificate and private key.

Importing New Certificates

When you have an SSL certificate issued by an SSL certificate provider, you can import it into the controller and use it for HTTPS communication.

To complete this procedure, you will need the following:

- The signed server certificate
- The intermediate CA certificate (at least one)
- The private key file

NOTE

The file size of each signed certificate and intermediate certificate must not exceed 8192 bytes. If a certificate exceeds 8192 bytes, you will be unable to import it into the controller.

Follow these steps to import a signed server certificate:

1. Copy the signed certificate file, intermediate CA certificate file, and private key file to a location (either on the local drive or a network share) that you can access from the controller web interface.
2. From the application select, **System > Certificates > Installed Certs**.
3. Click **Import**, the Import Certificate form appears.
4. Enter a **Name** to identify the certificate.
5. Enter a **Description** about the certificate.
6. For **Service Certificates**, click **Browse** and select the location where the certificate is saved.
7. For **Intermediate CA certificates**, click **Browse** and select the location where the certificate is saved. If you need to upload additional intermediate CA certificates to establish a chain of trust to the signed certificate, you can select up to four certificates.
8. If you are using this SSL certificate for a Hotspot 2.0 configuration, you must also import a root CA certificate. To import **Root CA Certificate**, click **Browse** and select the location where the certificate is saved.
9. You can import the **Private Key** file either by
 - uploading file—choose **Upload** and click **Browse** to select the location.
 - using CSR—choose **Using CSR** and select the CSR that you generated earlier.
10. Enter the **Key Phrase** that has been assigned to the private key file.
11. Click **OK**.

NOTE

You can also edit or delete a certificate by selecting the options **Configure** or **Delete** respectively.

Assigning Certificates to Services

You can map certificates to services

To specify the certificate that each secure service will use:

1. From the application select, **System > Certificates > Service Certs**.
2. Select the certificate that you want to use for each of the following services:
 - **Management Web**—Used by Web UI and Public API traffic.
 - **AP Portal**—Used by Web Auth WLAN and Guest Access WLAN control traffic.

- **Hotspot (WISPr)**—Used by WISPr WLAN control (Northbound Interface, Captive Portal, and Internal Subscriber Portal) traffic.
 - **Communicator**—Used by AP control traffic.
3. To view the public key, click **View Public Key**, the Certificate Public Key form appears with the public key.
 4. Click **OK**.

Generating Certificate Signing Request (CSR)

If you do not have an SSL certificate, you will need to create a certificate signing request (CSR) file and send it to an SSL certificate provider to purchase an SSL certificate.

To create a CSR file:

1. From the application select, **System > Certificates > CSR**.
2. Click **Generate**, the Generate CSR form appears.
3. Enter the following details:
 - **Name**—A name for this CSR.
 - **Description**— A short description for this CSR.
 - **Common Name**—A fully qualified domain name of your Web server. This must be an exact match (for example, **www.ruckuswireless.com**).
 - **Email**—An email address (for example, **joe@ruckuswireless.com**).
 - **Organization**—Complete legal name of your organization (for example, **Ruckus Wireless, Inc.**). Do not abbreviate your organization name.
 - **Organization Unit**—Name of the division, department, or section in your organization that manages network security (for example, **Network Management**).
 - **Locality/City**—City where your organization is legally located (for example, **Sunnyvale**).
 - **State/Province**—State or province where your organization is legally located (for example, **California**) Do not abbreviate the state or province name.
4. Select the **Country**
5. Click **OK**, the controller generates the certificate request. When the certificate request file is ready, your web browser automatically downloads it.
6. Go to the default download folder of your Web browser and locate the certificate request file. The file name is **myreq.zip**.
7. Use a text editor (for example, Notepad) to open the certificate request file.
8. Go to the website of your preferred SSL certificate provider, and then follow the instructions for purchasing an SSL certificate.
9. When you are prompted for the certificate signing request, copy and paste the entire content of myreq.csr, and then complete the purchase.
10. After the SSL certificate provider approves your CSR, you will receive the signed certificate via email.
11. Copy the content of the signed certificate, and then paste it into a text file.
12. Save the file.

NOTE

You can also edit, clone, download or delete a CSR by selecting the options **Configure**, **Clone**, **Download** or **Delete** respectively.

Managing AP Certificates

AP certificates are valid for a period of time and have to be replaced when they expire.

NOTE

Although AP Certificate Expire Check is enabled by default, when an AP with an expired certificate joins the controller, this check automatically gets disabled. To restore security:

- All APs with expired certificates need to be replaced with a new valid certificate
- Manually enable certificate check using `ap-cert-expired-check` CLI command in the config mode

You must get AP Certificate Replacement before your AP certificate expires. The system generates an *apCertificateExpireSystem* alarm and event when an AP certificate expires.

To get an AP Certificate replacement:

1. From the application select, **System > Certificates > AP Certificate Replacement**.
2. In the AP Request List area, those APs with the **Need Export** column marked **Yes** needs certificate replacement. Those marked with **No** means that the certificate request has already been exported.

NOTE

Use the Search terms option to look for APs by name, model, serial number, or description.

3. Click **Export** and select one of the following options:
 - **Export All APs Certificate Request**—Exports the certificates for all the AP
 - **New APs**—Exports the certificates for new APs or APs that need to regenerate their certificates.

NOTE

All exported AP Certificate request (.req) files generated from a cluster include its name. To manage multiple export request files, change the file name before uploading it to uniquely identify the file.

For example: cert-scg-cluster5f6433ef-711b-4f44-b38a-ddd485ee2c37-R500.req

4. Login <https://support.ruckuswireless.com/> with your credentials.
5. From the right pane go to **Tools > Certificate Renewal**. The Certificate Renewal Requests page appears.
6. Click **Browse** to select the .req file exported from Certificate Refresh page.
7. Enter the Email address for communication.
8. Click **Upload**, you will receive an e-mail acknowledgment from Ruckus Wireless.
9. From the Certificate Renewal Request page, check the **Status** column of your request. After the request is processed, you will receive the response from Ruckus Wireless, with a link to the .res response file for Import on the Certificate Refresh page.
10. From the AP Certificate Replacement page of the application, click **Import AP certificate Response (.res) file**. The Import AP certificate for replacement form appears.
11. Click **Browse** and select the file.
12. Click **OK**.

NOTE

All APs included in the imported response (.res) file reboot after their certificate is refreshed.

13. From the Certificate Status area, check the **Status** column of the AP. If the status is:

- **Updating**—Controller is in the process of updating the certificate.
- **Update Failed**—Controller failed to update the certificate.

NOTE

The AP reports to the controller at 15-minute intervals. As a result, it may take up to 15 minutes for the AP to update its certificate status on the web interface.

14. Click **Reset Update Failed AP**, to reset the status of the APs for which certification update failed. The status of the AP will change.

15. Check the **Update Stats** to know the status of the AP certificates.

16. Once all the APs are updated with the new certificates, manually enable the `ap-cert-expired-check` CLI command in the config mode to restore security and reject APs that try to connect with expired certificate

Importing Trusted CA Certificates

When a controller receives a server's certificate, it matches the server's CA against the list of trusted CAs it has. If there is no match, the controller sends an error.

To import a CA certificate:

1. From the application select, **System > Certificates > Trusted CA Certs (Chain)**.
2. Click **Import**, the Import CA Certs (Chain) form appears.
3. Enter a **Name**.
4. Enter a **Description** of the certificate.
5. For **Intermediate CA Certificates**, click **Browse** and select the file. If you need to upload additional intermediate CA certificates to establish a chain of trust to the signed certificate, you can select up to four certificates.
6. For **Root CA Certificate**, click **Browse** and select the file.
7. Click **OK**.

NOTE

You can also edit or delete a CA certificate by selecting the options **Configure** or **Delete** respectively.

Configuring Templates

Working with Zone Templates

In 3.6 SCG200-C is supported. SCG200-C is the SCG200 model without the internal DP functions. If Ruckus GRE tunnel is enabled, upgrade to SCG200-C is blocked and the following message appears:

```
There exists a Zone template [TEMPLATE_NAME] with RuckusGRE tunnel is applied
```

You can create, configure, and clone zone templates

Creating Zone Templates

To create a zone template:

1. From the application select, **System > Templates > Zone Templates**.
2. Click **Create**, the Create Zone Template form appears.
3. Enter the template details as explained in [Table 8](#).
4. Click **OK**.

TABLE 8 Zone Template Details

Field	Description	Your Action
General Options		
Zone Name	Indicates a name for the Zone.	Enter a name.
Description	Indicates a short description.	Enter a brief description
AP Firmware	Indicates the firmware to which it applies.	Select the firmware.
Country Code	Indicates the country code to ensure that this zone uses authorized radio channels.	Select the country code.
Location	Indicates generic location.	Enter the location.
Location Additional Information	Indicates detailed location.	Enter additional location information.
GPS Coordinates	Indicates the geographical location.	Enter the following coordinates in meters or floor: <ul style="list-style-type: none"> • Longitude • Latitude • Altitude
AP Admin Logon	Indicates the admin logon credentials.	Enter the Logon ID and Password .
Time Zone	Indicates the time zone that applies.	Select the option: <ul style="list-style-type: none"> • System Defined: Select the time zone. • User defined: <ol style="list-style-type: none"> 1. Enter the Time Zone Abbreviation. 2. Choose the GMT Offset time. 3. Select Daylight Saving Time.
AP IP Mode	Indicates the IP version that applies.	Select the option: <ul style="list-style-type: none"> • IPv4 only • Dual
Cluster Redundancy	Provides cluster redundancy option for the zone. <p>NOTE Cluster redundancy is supported only on SZ300 and vSZ-H.</p>	Select the required option: <ul style="list-style-type: none"> • Zone Enable • Zone Disable
Radio Options		
Channel Range	Indicates that you want to override the 2.4GHz channel range that has been configured for the zone.	Select Select Channel Range (2.4G) check boxes for the channels on which you want the 2.4GHz radios to operate. Channel options include channels 1 to 11. By default, all channels are selected.
DFS Channels	Allows ZoneFlex APs to use DFS channels.	Select the check box.
Channel Range (5G) Indoor	Indicates for what channels want the 5GHz radios to operate.	Select the check boxes.
Channel Range (5G) Outdoor	Indicates for what channels want the 5GHz radios to operate.	Select the check boxes.

TABLE 8 Zone Template Details (continued)

Field	Description	Your Action
Radio Options b/g/n (2.4 GHz)	Indicates the radio option 2.4 GHz configurations.	<p>Select the following options:</p> <ul style="list-style-type: none"> • Channelization—Set the channel width used during transmission to either 20 or 40 (MHz), or select Auto to set it automatic. • Channel—Select the channel to use for the b/g/n (2.4GHz) radio, or select Auto to set it automatic. • TX Power Adjustment—Select the preferred TX power, if you want to manually configure the transmit power on the 2.4GHz radio. By default, TX power is set to Full/Auto on the 2.4GHz radio. <p>NOTE If you choose Min, the transmit power is set to 0dBm (1mW) per chain for 11n APs, and 2dBm per chain for 11ac APs. If you choose Max, the transmit power is set to the max allowable value according to the AP's capability and the operating country's regulations.</p>
Radio Options a/n/ac (5 GHz)	Indicates the radio option 5 GHz configurations.	<p>Select the following options:</p> <ul style="list-style-type: none"> • Channelization—Set the channel width used during transmission to either 20, 40, 80, 80+80 or select Auto. • Channel—For Indoor and Outdoor, select the channel to use for the a/n/c (5GHz) radio, or select Auto. • TX Power Adjustment—Select the preferred TX power, if you want to manually configure the transmit power on the 5GHz radio. By default, TX power is set to Full/Auto on the 5GHz radio. <p>NOTE If you choose Min, the transmit power is set to 0dBm (1mW) per chain for 11n APs, and 2dBm per chain for 11ac APs. If you choose Max, the transmit power is set to the max allowable value according to the AP's capability and the operating country's regulations.</p>
AP GRE Tunnel Options		
Tunnel Type	Indicates the support for NAT.	Select the required option.
GRE Tunnel Profile	Indicates the tunnel profile.	<p>Select the required option or click Create and enter the following details:</p> <ul style="list-style-type: none"> • Name • Description • Ruckus Tunnel Mode • Tunnel Encryption • WLAN Interface MTU

TABLE 8 Zone Template Details (continued)

Field	Description	Your Action
Syslog Options		
Enable external syslog server for Aps	Indicates if an external syslog server is enabled.	Select the check box and update the following details: <ul style="list-style-type: none"> • Server Address • Port • Facility for Event • Priority
AP SNMP Options		
Enable AP SNMP	Indicates if the AP SNMP option is enabled.	Select the check box.
SNMPv2 Agent	Indicates SNMPv2 Agent is applied.	<ol style="list-style-type: none"> 1. Click Create and enter Community. 2. Select the required Privilege: Read or Write. 3. Click OK.
SNMPv3 Agent	Indicates SNMPv3 Agent is applied.	<ol style="list-style-type: none"> 1. Click Create and enter User. 2. Select the required Authentication: <ul style="list-style-type: none"> • None • SHA <ol style="list-style-type: none"> 1. Enter the Auth Pass Phrase 2. Select the Privacy option. For DES and AES options, Enter the Privacy Phrase. • MD5 <ol style="list-style-type: none"> 1. Enter the Auth Pass Phrase 2. Select the Privacy option. For DES and AES options, Enter the Privacy Phrase. 3. Select the required Privilege: Read or Write. 4. Click OK.
Advanced Options		
Channel Mode	Indicates if location-based service is enabled.	Select the check box and choose the option.
Auto Channel Selection	Indicates auto-channel settings.	Select the required check boxes and choose the option.
Background Scan	Runs a background scan.	Select the respective check boxes and enter the duration in seconds.
Smart Monitor	Indicates AP interval check and retry threshold settings.	Select the check box and enter the duration and threshold.
AP Management VLAN	Indicates the AP management VLAN settings.	Choose the option. If you select VLAN ID , enter the VLAN ID that you want to assign (valid range is from 1 to 4094). To keep the same management VLAN ID that has been configured on the AP, click Keep AP's settings
Rogue AP Detection	Indicates rogue AP settings.	<ol style="list-style-type: none"> 1. Select the check box and choose the options: <ul style="list-style-type: none"> • Enable events and alarms for all rogue devices • Enable events and alarms for only malicious rogue devices of selected types and choose the Rogue Type: <ul style="list-style-type: none"> – SSID Spoofing – Same Network – MAC Spoofing

TABLE 8 Zone Template Details (continued)

Field	Description	Your Action
		<ul style="list-style-type: none"> Select the Protect the network from malicious rogue access points check box.
DoS Protection	Indicates settings for blocking a client.	Select the check box and enter the: <ul style="list-style-type: none"> duration in seconds to Block a client for number of repeat authentication failures duration in seconds to be blocked for every repeat authentication failures.
Client Load Balancing	Balances the number of clients across APs.	Select the check box and enter the threshold.
Band Balancing	Balances the bandwidth of the clients.	Select the check box and enter the percentage.
Location Based Service	To disable the LBS service for this AP group, clear the Enable LBS service check box. To use a different LBS server for this AP group, select the Enable LBS service check box, and then select the LBS server that you want to use from the drop-down list.	Select the check box and choose the options.
Client Admission Control	Indicates the load thresholds on the AP at which it will stop accepting new clients. NOTE Client admission cannot be enabled when client load balancing or band balancing is enabled.	Select the Enable check box 2.4 GHz Radio or 5GHz Radio and update the following details: <ul style="list-style-type: none"> Min Client Count Max Radio Load Min Client Throughput
AP Reboot Timeout	Indicates AP reboot settings.	Choose the required option for: <ul style="list-style-type: none"> Reboot AP if it cannot reach default gateway after Reboot AP if it cannot reach the controller after

NOTE

You can select a zone from the list and edit, clone or delete its template by selecting the options **Configure**, **Clone** or **Delete** respectively.

Applying Zone Templates

To apply a zone template:

- From the application select, **System > Templates > Zone Templates**.
- From the list, select the zone template that you want to apply and click **Apply**. The Apply Zone Templates form appears.
- From **Select AP Zone**, select the required zone.
- Click **Apply**.

Exporting Zone Templates

You can export a zone template.

To export a zone template:

- From the application select, **System > Templates > Zone Templates**.

2. Select the zone template that you want to export and click **Export Template**.
3. A pop-up appears prompting you to **Open** or **Save** the zone template file with **.bak** extension. Click:
 - **Open**—To view the template file
 - **Save**—Select the destination folder where you want to save the template file and then click **Open** to view it.

Importing Zone Templates

You can import zone templates and upload them to the system.

NOTE

Configuration references to global services or profiles cannot be imported, manually configure it after importing.

To import a zone template:

1. From the application select, **System > Templates > Zone Templates**.
2. Click **Import**, the Import Zone Templates form appears.
3. Click **Browse** and select the template file.
4. Click **Upload**.

Working with WLAN Templates

In 3.6 SCG200-C is supported. SCG200-C is the SCG200 model without the internal DP functions. If Ruckus GRE tunnel is enabled, upgrade to SCG200-C is blocked and the following message appears:

```
There exists a WLAN template [TEMPLATE_NAME] with RuckusGRE tunnel is applied
```

You can create, configure and clone a WLAN template.

Creating WLAN Templates

To create a WLAN template:

1. From the application select, **System > Templates > WLAN Templates**.
2. Click **Create**, the Create WLAN Template form appears.
3. Enter a **Template Name**.
4. Enter a **Description**.
5. Select the **Template Firmware**.
6. Choose the **AP IP Mode**.
7. Select **AP SoftGRE Tunnel** to enable all WLANs defined in this template to tunnel traffic to SoftGRE through the AP.
8. Click **OK**.

NOTE

You can select a WLAN and edit, clone or delete its template by selecting the options **Configure**, **Clone** or **Delete** respectively.

Applying a WLAN Template

To Apply a WLAN template to a zone:

1. From the application select, **System > Templates > WLAN Templates**.
2. From the list, select the WLAN template that you want to apply and click **Apply**. The Apply WLAN Template to selected zones form appears.
3. From **Select AP Zone**, select the required zone.
4. Click **Apply**.

Working With Access Points

- Understanding the System, Domains, Zones and AP Groups..... 75
- Viewing Modes..... 94
- AP Status..... 94
- Configuring Access Points..... 94
- Managing Access Points..... 97

The following image gives you an understanding of the Access Points home page.

FIGURE 32 Access Points

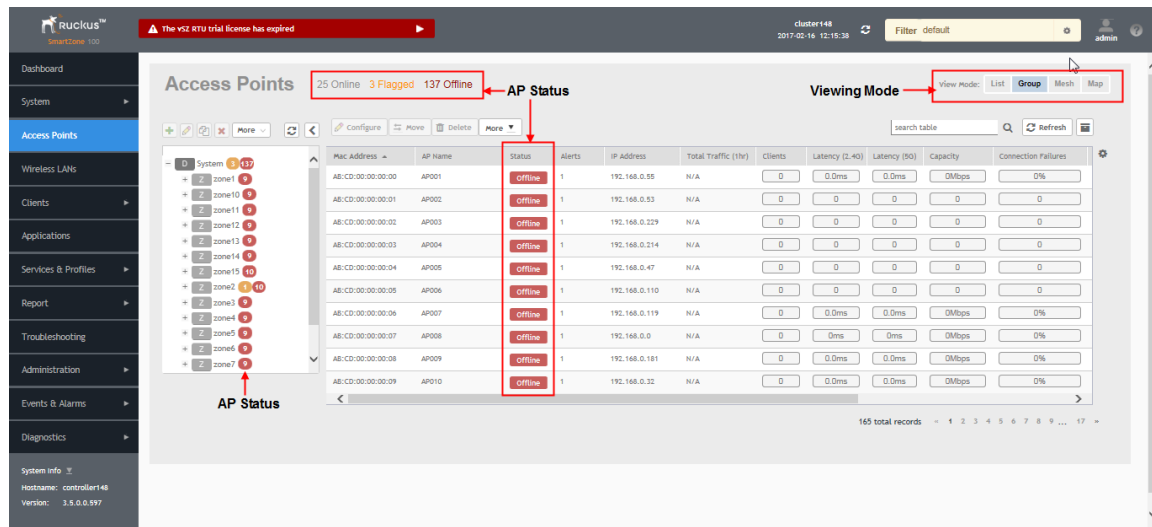

Understanding the System, Domains, Zones and AP Groups

Hierarchy Overview

The hierarchy helps in specifying which AP groups or APs provide which WLAN services.

You can virtually split them using the following hierarchy:



- System—Highest order that comprises of multiple zones
- Domains—Broad classification that comprises of multiple Zones.
- Zones—Comprises of multiple AP groups
- AP groups—Comprises of multiple APs
- APs—Individual access points.

Creating an AP Domain

To create an AP domain:

1. From the System tree hierarchy, select the location where you want to create the domain.
2. Click the **Create**  button, the Create Group form appears.
3. Configure the following details:
 - a. Enter a **Name** for the domain.
 - b. Enter a **Description** about the domain.
 - c. By default, the **Type** selected is **Domain**.
 - d. The **Parent Group** displays the group to which this domain will be tagged.
 - e. If you want to create a domain to manage MSP-related settings within that domain, in the **Managed by Partner** field, select the **Enable** check box.
4. Click **OK**.

NOTE

You can also edit, clone and delete an AP Domain by selecting the options **Configure** , **Clone**  or **Delete**  respectively, from the Access Points page.

Working with AP Zones

An AP zone functions as a way of grouping Ruckus Wireless APs and applying a particular set of settings (including WLANs and their settings) to this group of Ruckus Wireless APs. Each AP zone can include up to 27 WLAN services.

By default, an AP zone named Staging Zone exists. Any AP that registers with the controller that is not assigned a specific zone is automatically assigned to the Staging Zone. This section describes how to use AP zones to manage devices.

NOTE

When an AP is assigned or moved to the Staging Zone, the cluster name becomes its user name and password after the AP shows up-to-date state. If you need to log on to the AP, use the cluster name for the user name and password.

Before creating an AP zone, Ruckus Wireless recommends that you first set the default system time zone on the General Settings page. This will help ensure that each new AP zone will use the correct country. For information on how to set the default system time zone, see [Configuring System Time](#) on page 34.

NOTE

In vSZ-H and SCG200, when the system is upgraded to release 3.5, the new UI and re-architected stats database will prevent the system from displaying AP and zone stats if the AP/zone is operating on 3.4 or prior releases. In order to make full use of the UI introduced in 3.5, zones and APs should be updated to 3.5 as well. Operationally, the zones will still work, but stats visibility will be impacted.

Creating an AP Zone

An AP zone (or zone) functions as a way of grouping Ruckus Wireless APs and applying settings including WLANs to these groups of Ruckus Wireless APs. Each AP zone can include up to six WLAN services.

To create an AP zone :

1. On the menu, click **Access Points**. The figure below appears.

FIGURE 33 Access Points

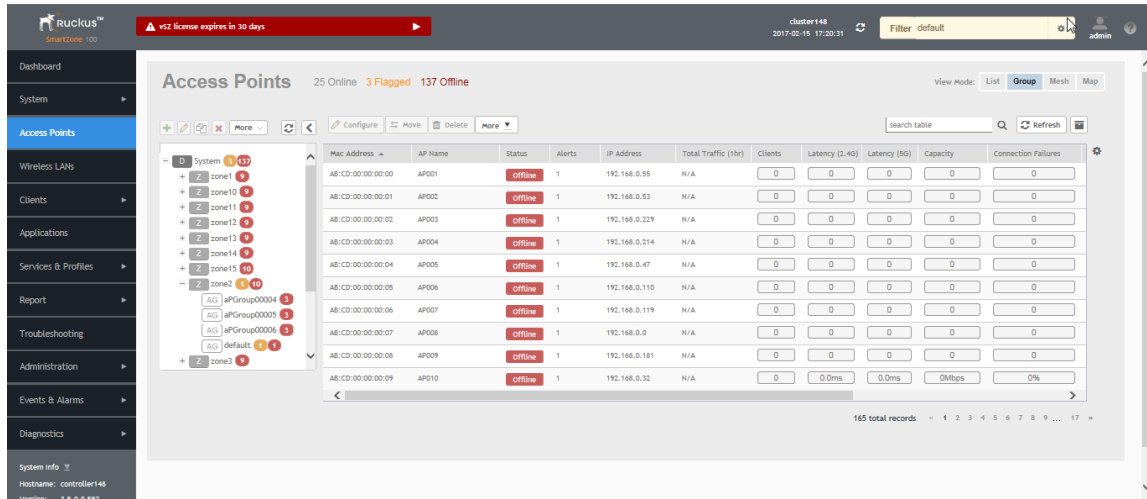

- From the **System** tree, select the location where you want to create the zone (for example, System or Domain), and then click .

FIGURE 34 Create Groups



- Configure the zone by completing the settings listed in the table below.
- Click **OK**.

TABLE 9 AP Zone Details

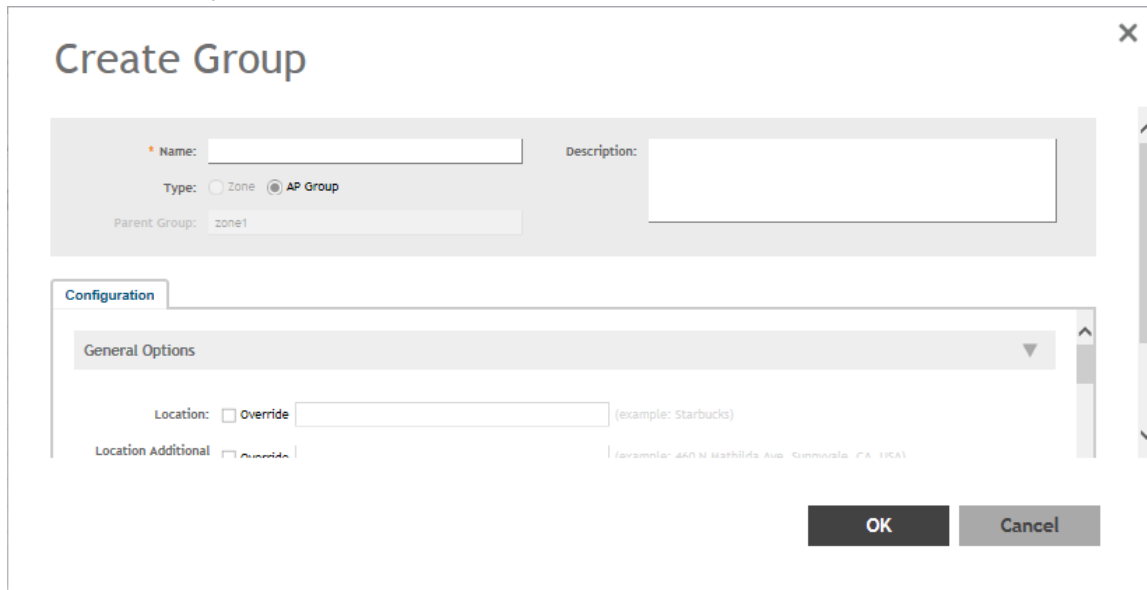
Field	Description	Your Action
Name	Indicates the name of the zone/AP group.	Enter a name.
Description	Indicates the short description assigned to the zone or AP group.	Enter a brief description

Working With Access Points

Understanding the System, Domains, Zones and AP Groups

TABLE 9 AP Zone Details (continued)

Field	Description	Your Action
Type	Indicates if you are creating a domain, zone or an AP group.	Appears by default. You can also choose the option.
Parent Group	Indicates the parent AP group.	Appears by default.
Configuration > General Options		
AP Firmware	Indicates the firmware to which it applies.	Select the firmware.
Country Code	Indicates the country code. Using the correct country code helps ensure that APs use only authorized radio channels.	Select the country code.
Location	Indicates the generic location of the zone.	Enter the location.
Location Additional Information	Indicates detailed location.	Enter additional location information.
GPS Coordinates	Indicates the geographical location.	Enter the following coordinates: <ul style="list-style-type: none"> • Longitude • Latitude • Altitude
AP Admin Logon	Indicates the admin logon credentials.	Enter the Logon ID and Password .
AP Time Zone	Indicates the time zone that applies.	Select a time zone, and then enter the details as required.
AP IP Mode	Indicates the IP version that applies.	Select the IP version. IPv6, IPv4 and dual addressing modes are supported.
Cluster Redundancy	Provides cluster redundancy option for the zone. <p>NOTE Cluster redundancy is supported only on SZ300 and vSZ-H.</p>	Select the required option: <ul style="list-style-type: none"> • Zone Enable • Zone Disable
Configuration > Mesh Options		
Enable Mesh Networking in this zone	Indicates if mesh networking is enabled.	Select the check box and enter the following: <ul style="list-style-type: none"> • Mesh Name (ESSID) • Mesh Passphrase
Configuration > Radio Options		
Channel Range (2.4G)	Indicates that you want to override the 2.4GHz channel range that has been configured for the zone to which this AP group belong.	Select Select Channel Range (2.4G) check boxes for the channels on which you want the 2.4GHz radios of managed APs to operate. Channel options include channels 1 to 11. By default, all channels are selected.
DFS Channels	Allows ZoneFlex APs to use DFS channels.	Select the check box.
Channel Range (5G) Indoor	Indicates the channels on the 5GHz radio that you want managed indoor APs to operate.	Select the check boxes.
Channel Range (5G) Outdoor	Indicates the channels on the 5GHz radio that you want managed outdoor APs to operate.	Select the check boxes.
Radio Options b/g/n (2.4 GHz)	Indicates the configuration options for the 2.4 GHz radio.	Select the following options: <ul style="list-style-type: none"> • Channelization—Set the channel width used during transmission to either 20 or 40 (MHz), or select Auto to set it automatically. • Channel—Select the channel to use for the b/g/n (2.4GHz) radio, or select Auto to set it automatically.

TABLE 9 AP Zone Details (continued)

Field	Description	Your Action
		<ul style="list-style-type: none"> • TX Power Adjustment—Select the preferred TX power, if you want to manually configure the transmit power on the 2.4GHz radio. By default, TX power is set to Full on the 2.4GHz radio. <p style="text-align: center;">NOTE</p> <p>If you choose Min, the transmit power is set to 0dBm (1mW) per chain for 11n APs, and 2dBm per chain for 11ac APs. If you choose Max, the transmit power is set to the max allowable value according to the AP's capability and the operating country's regulations.</p>
Radio Options a/n/ac (5 GHz)	Indicates the configuration options for the 5 GHz radio.	<p>Select the following options:</p> <ul style="list-style-type: none"> • Channelization—Set the channel width used during transmission to either 20, 40, 80, 80+80, 160 (MHz), or select Auto to set it automatically. • Channel—For Indoor and Outdoor, select the channel to use for the a/n/c (5GHz) radio, or select Auto to set it automatically. • Secondary Channel (80+80)—For Indoor and Outdoor, the default secondary channel to use for the a/n/c (5GHz) radio, is set as Auto. • TX Power Adjustment—Select the preferred TX power, if you want to manually configure the transmit power on the 5GHz radio. By default, TX power is set to Full on the 5GHz radio. <p style="text-align: center;">NOTE</p> <p>If you choose Min, the transmit power is set to 0dBm (1mW) per chain for 11n APs, and 2dBm per chain for 11ac APs. If you choose Max, the transmit power is set to the max allowable value according to the AP's capability and the operating country's regulations.</p>
Configuration > AP GRE Tunnel Options		
Tunnel Type	Indicates the supported tunnel type (Ruckus GRE, SoftGRE and SoftGRE+IPsec)	<p>Choose :</p> <ul style="list-style-type: none"> • Ruckus GRE and select the GRE Tunnel Profile. • SoftGRE and select the GRE Tunnel Profile. • SoftGRE+IPsec and select the IPSec Tunnel Profile.
Configuration > Syslog Options		
Enable external syslog server for APs	Indicates if an external syslog server is enabled.	<p>Select the check box and enter the following details:</p> <ul style="list-style-type: none"> • Server Address • Port • Facility for Event

Working With Access Points

Understanding the System, Domains, Zones and AP Groups

TABLE 9 AP Zone Details (continued)



Field	Description	Your Action
<p>• Priority</p>		
<p>Configuration > AP SNMP Options</p>		
Enable AP SNMP	Indicates if the AP SNMP option is enabled.	Select the check box.
SNMPv2 Agent	Indicates if the SNMPv2 agent is enabled.	<p>If the SNMPv2 agent is enabled, configure the community settings.</p> <ol style="list-style-type: none"> 1. Click Create and enter Community. 2. Select the required Privilege. If you select Notification enter the Target IP. 3. Click OK.
SNMPv3 Agent	Indicates SNMPv3 Agent is applied.	<p>If the SNMPv3 agent is enabled, configure the community settings.</p> <ol style="list-style-type: none"> 1. Click Create and enter User. 2. Select the required Authentication. 3. Enter the Auth Pass Phrase. 4. Select the Privacy option. 5. Select the required Privilege. If you select Notification select the option Trap or Inform and enter the Target IP and Target Port. 6. Click OK.
<p>Configuration > Advanced Options</p>		
Channel Mode	Indicates if location-based service is enabled. If you want to allow indoor APs that belong to this zone to use wireless channels that are Channel Mode regulated as indoor-use only.	Select the Allow indoor channels check box.
Auto Channel Selection	Indicates auto-channel settings.	Select the check box and choose the option.
Background Scan	Runs a background scan.	<p>Select the respective check boxes and enter the duration in seconds:</p> <ul style="list-style-type: none"> • Background Scanning—Changes the AP channel if there is interference. • ChannelFly—Continuously monitors potential throughput and changes the AP channel to minimize interference and optimize throughput.
Smart Monitor	Indicates AP interval check and retry threshold settings.	Select the check box and enter the interval and threshold.
AP Management VLAN	Indicates the AP management VLAN settings.	Choose the option. Click VLAN ID , and then type the VLAN ID that you want to assign (valid range is from 1 to 4094). To keep the same management VLAN ID that has been configured on the AP, click Keep AP's settings
Rogue AP Detection	Indicates rogue AP settings.	<p>Select the check box and choose the options:</p> <ul style="list-style-type: none"> • Enable events and alarms for all rogue devices • Enable events and alarms for only malicious rogue devices of selected type and select the Rogue Type: <ul style="list-style-type: none"> – SSID Spoofing – Same Network – MAC Spoofing • Protect the network from malicious rogue access points.

TABLE 9 AP Zone Details (continued)

Field	Description	Your Action
DoS Protection	Indicates settings for blocking a client.	Select the check box and enter the duration in seconds.
Client Load Balancing	Balances the number of clients across APs.	Select the check box and enter the threshold.
Band Balancing	Balances the bandwidth of the clients.	<p>You can use the slider to actively control associated stations to meet certain band distribution requirements allowing for dynamic band balancing:</p> <ul style="list-style-type: none"> • Disable: disables band balancing • Basic (default): during heavy load conditions, this option withholds probe and authentication responses in order to balance clients. • Proactive: uses the Basic configuration in addition to actively re-balancing clients. • Strict: uses the Proactive configuration in addition to actively re-balancing clients. <p>Enter the percentage of client load on the 2.4 GHz band.</p>
Location Based Service	Indicates that the location based service is enabled.	<ul style="list-style-type: none"> • Select the check box and choose the options. • Click Create, In the Create LBS Server form: <ol style="list-style-type: none"> 1. Enter the Venue Name. 2. Enter the Server Address. 3. Enter the Port number. 4. Enter the Password.
Client Admission Control	Indicates the load thresholds on the AP at which it will stop accepting new clients.	<p>Select the check box and update the following settings:</p> <ul style="list-style-type: none"> • Min Client Count • Max Radio Load • Min Client Throughput
Protection Mode	Indicates the mechanism to reduce frame collision.	<p>Choose one of the following options:</p> <ul style="list-style-type: none"> • None • RTS/CTS • CTS Only
AP Reboot Timeout	Indicates the AP reboot settings.	<p>Choose the required option for:</p> <ul style="list-style-type: none"> • Reboot AP if it cannot reach default gateway after • Reboot AP if it cannot reach the controller after

For SCG200, SZ300 and vSZ-H, you can also migrate the Zone configuration from a regular Domain to a Partner Domain. For more information, see <https://support.ruckuswireless.com/answers/000006414>

NOTE

You can also edit, clone or delete an AP Zone by selecting the options **Configure** , **Clone**  or **Delete**  respectively, from the Access Points page.

ChannelFly and Background Scanning

SmartZone controllers offer the ChannelFly and Background Scanning automatic channel selection methods for spectrum utilization and performance optimization. While Background Scanning must be enabled for rogue AP detection, AP location detection and radio power adjustment, either can be used for automatic channel optimization.

Working With Access Points

Understanding the System, Domains, Zones and AP Groups

The main difference between ChannelFly and Background Scanning is that ChannelFly determines the optimal channel based on real-time statistical analysis of actual throughput measurements, while Background Scanning uses channel measurement and other techniques to estimate the impact of interference on Wi-Fi capacity based on progressive scans of all available channels.

NOTE

If you enable ChannelFly, Background Scanning can still be used for adjusting radio power and rogue detection while ChannelFly manages the channel assignment. Both cannot be used at the same time for channel management.

Benefits of ChannelFly

With ChannelFly, the AP intelligently samples different channels while using them for service. ChannelFly assesses channel capacity every 15 seconds and changes channel when, based on historical data, a different channel is likely to offer higher capacity than the current channel. Each AP makes channel decisions based on this historical data and maintains an internal log of channel performance individually.

When ChannelFly changes channels, it utilizes 802.11h channel change announcements to seamlessly change channels with no packet loss and minimal impact to performance. The 802.11h channel change announcements affect both wireless clients and Ruckus mesh nodes in the 2.4 GHz and/or 5 GHz bands.

Initially (in the first 30-60 minutes) there will be more frequent channel changes as ChannelFly learns the environment. However, once an AP has learned about the environment and which channels are most likely to offer the best throughput potential, channel changes will occur less frequently unless a large measured drop in throughput occurs.

ChannelFly can react to large measured drops in throughput capacity in as little as 15 seconds, while smaller drops in capacity may take longer to react to.

Disadvantages of ChannelFly

Compared to Background Scanning, ChannelFly takes considerably longer for the network to settle down. If you will be adding and removing APs to your network frequently, Background Scanning may be preferable. Additionally, if you have clients that do not support the 802.11h standard, ChannelFly may cause significant connectivity issues during the initial capacity assessment stage.

You can enable/disable ChannelFly per band. If you have 2.4 GHz clients that do not support 802.11h, Ruckus recommends disabling ChannelFly for 2.4 GHz but leaving it enabled for the 5 GHz band.

Background Scanning

Using Background Scanning, SmartZone controllers regularly samples the activity in all Access Points to assess RF usage, to detect rogue APs and to determine which APs are near each other for mesh optimization. These scans sample one channel at a time in each AP so as not to interfere with network use. This information is then applied in AP Monitoring and other controller monitoring features. You can, if you prefer, customize the automatic scanning of RF activity, deactivate it if you feel it's not helpful, or adjust the frequency, if you want scans at greater or fewer intervals.

NOTE

Background Scanning must be enabled for SmartZone controllers to detect rogue APs on the network.

VLAN Pooling

When Wi-Fi is deployed in a high density environment (such as a stadium) or on a university campus to provide access for students, the number of IP addresses required for client devices can easily run into several thousands.

Allocating a single large subnet results in a high probability of degraded performance due to factors like broadcast/multicast traffic.

To address this problem, VLAN pooling provides a method by which administrators can deploy pools of multiple VLANs from which clients are assigned, thereby automatically segmenting large groups of clients into smaller subgroups, even when connected to the same SSID.

As the client device joins the Wi-Fi network, the VLAN is assigned based on a hash of the client's MAC address (by default).

Working with AP Groups

AP (access point) groups can be used to define configuration options and apply them to groups of APs at once, without having to individually modify each AP's settings.

For each group, administrators can create a configuration profile that defines the channels, radio settings, Ethernet ports and other configurable fields for all members of the group or for all APs of a specific model in the group. AP groups are similar to WLAN groups (see Working with WLAN Groups for more information). While WLAN groups can be used to specify which WLAN services are served by which APs, AP groups are used for more specific fine-tuning of how the APs themselves behave.

NOTE

AP group configuration settings can be overridden by individual AP settings. For example, if you want to set the transmit power to a lower setting for only a few specific APs, leave the Tx Power Adjustment at **Auto** in the AP group configuration page, then go to the individual AP configuration page (**Access Points > Access Points > Edit [AP MAC address]**) and set the **Tx Power Adjustment** to a lower setting.

Creating an AP Group

Creating an AP group means creating a configuration profile that defines the channels, radio settings, Ethernet ports and other configurable fields for all members of the group or for all APs of a specific model in the group.

Follow these steps to create an AP group.

1. From the left pane, select **Access Points**. The below figure appears.

FIGURE 35 Access Point

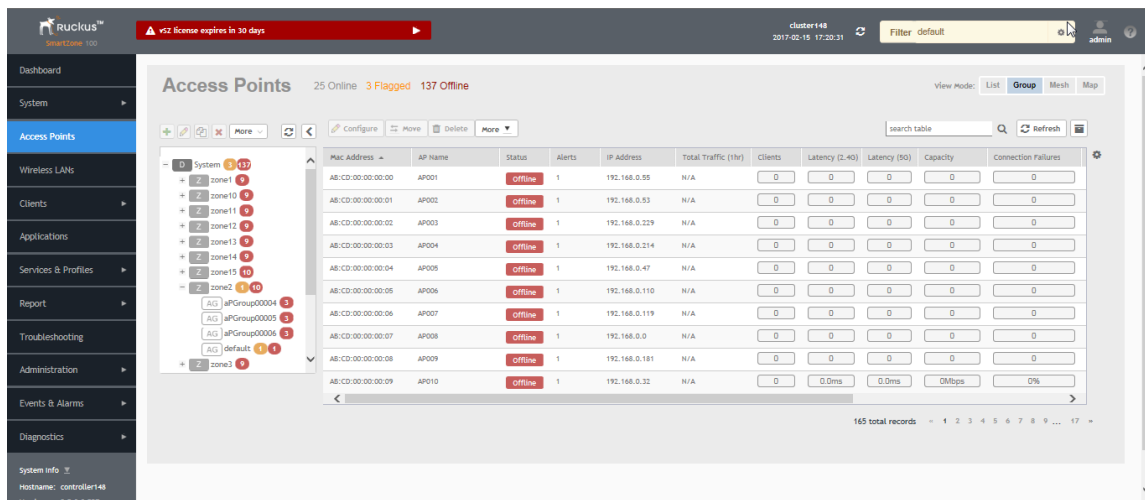

2. From the System tree hierarchy, select the location (for example: System, Domain, Zone) and click . The following figure appears.

FIGURE 36 Create Groups

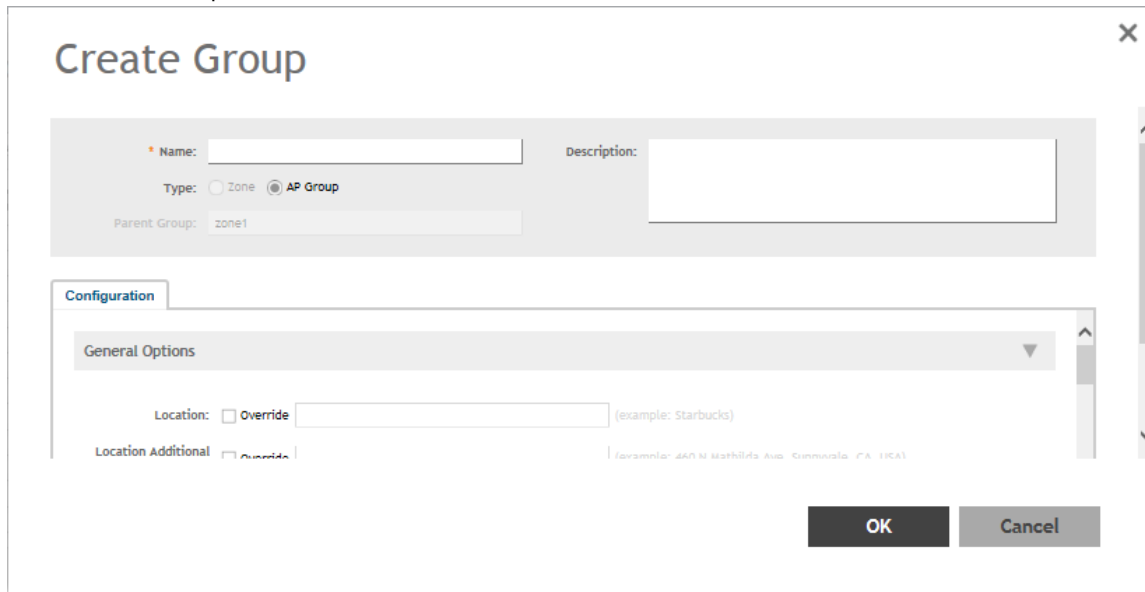

3. Enter the details as explained in the following table.

NOTE

You can also edit the configuration of default APs by selecting the AP and clicking the  icon.

4. Click **OK**.

TABLE 10 AP Group Details

Field	Description	Your Action
Name	Indicates a name for the Zone/AP group.	Enter a name.
Description	Indicates a short description.	Enter a brief description
Type	Indicates if you are creating a domain, zone or an AP group.	Appears by default. You can also choose the option.
Parent Group	Indicates the parent group that this AP group belongs.	Appears by default.
Configuration > General Options		
Location	Indicates generic location.	Enter the location.
Location Additional Information	Indicates detailed location.	Enter additional location information.
GPS Coordinates	Indicates the geographical location.	Enter the following coordinates in meters or floor: <ul style="list-style-type: none"> • Longitude • Latitude • Altitude
Configuration > Group Members		
Members	Displays the list of APs that belong to the group.	Select the members from the list and click Move to to assign them to the required group.
Access Points	Displays the list of APs that belong to the zone.	Select the Access Points from the list and click Add to Group .
Configuration > Radio Options		

TABLE 10 AP Group Details (continued)

Field	Description	Your Action
Channel Range (2.4G)	Indicates that you want to override the 2.4GHz channel range that has been configured for the zone to which this AP group belong.	Select Select Channel Range (2.4G) check boxes for the channels on which you want the 2.4GHz radios of managed APs to operate. Channel options include channels 1 to 11. By default, all channels are selected.
Channel Range (5G) Indoor	Indicates for what channels want the 5GHz radios of managed indoor APs to operate.	Select the check boxes.
Channel Range (5G) Outdoor	Indicates for what channels want the 5GHz radios of managed outdoor APs to operate.	Select the check boxes.
Radio Options b/g/n (2.4 GHz)	Indicates the radio option 2.4 GHz configurations.	Select the following options: <ul style="list-style-type: none"> • Channelization—Set the channel width used during transmission to either 20 or 40 (MHz), or select Auto to set it automatically. • Channel—Select the channel to use for the b/g/n (2.4GHz) radio, or select Auto to set it automatically. • TX Power—Select the preferred TX power, if you want to manually configure the transmit power on the 2.4GHz radio. By default, TX power is set to Full on the 2.4GHz radio • WLAN Group—Specifies to which WLAN group this AP group belongs.
Radio Options a/n/ac (5 GHz)	Indicates the radio option 5 GHz configurations.	Select the following options: <ul style="list-style-type: none"> • Channelization—Set the channel width used during transmission to either 20, 40, 80, 80+80, 160 (MHz), or select Auto to set it automatically. • Channel—For Indoor and Outdoor, select the channel to use for the a/n/c (5GHz) radio, or select Auto to set it automatically. • TX Power—Select the preferred TX power, if you want to manually configure the transmit power on the 5GHz radio. By default, TX power is set to Full on the 5GHz radio. • WLAN Group—Specify to which WLAN group this AP group belongs.
Configuration > AP SNMP Options		
Override zone configuration	Indicates that the AP Group configuration overrides the zone configuration.	Select the check box.
Enable AP SNMP	Indicates if the AP SNMP option is enabled.	Select the check box.
SNMPv2 Agent	Indicates SNMPv2 Agent is applied.	<ol style="list-style-type: none"> 1. Click Create and enter Community. 2. Select the required Privilege. If you select Notification enter the Target IP. 3. Click OK.
SNMPv3 Agent	Indicates SNMPv3 Agent is applied.	<ol style="list-style-type: none"> 1. Click Create and enter User. 2. Select the required Authentication. 3. Enter the Auth Pass Phrase. 4. Select the Privacy option. 5. Select the required Privilege. If you select Notification select the option Trap or Inform and enter the Target IP and Target Port.

Working With Access Points

Understanding the System, Domains, Zones and AP Groups



TABLE 10 AP Group Details (continued)

Field	Description	Your Action
		6. Click OK .
Configuration > Model Specific Options		
<p>NOTE Select the Override check box for that setting, and then configure the setting.</p>		
AP Model	Indicate the AP model for which you are configuring.	Select the option.
Status LEDs	Disable the status LED on the selected AP model.	Select the option.
LLDP	Enables the Link Layer Discovery Protocol (LLDP) on the selected AP model.	Select the option and enter the following details: <ul style="list-style-type: none"> • Advertise Interval—Enter the duration in seconds. • Hold Time—Enter the duration in seconds. • Enable Management IP TLV—Select the check box.
External Antenna (2.4 GHz)	Enables the external 2.4 GHz antenna on the selected AP model.	Select the Enable external antenna check box, and then set the gain value (between 0 and 90dBi) in the box provided.
External Antenna (5 GHz)	Enables the external 5 GHz antenna on the selected AP model.	Select the Enable external antenna check box, and then set the gain value (between 0 and 90dBi) in the box provided.
Port Settings	Indicates the port settings.	Select the option and choose the required LAN option.
PoE out port	Enables PoE out mode.	Select the Enable PoE out ports (specific ZoneFlex AP models only) check box.
PoE Operating Mode	Indicates the PoE operating mode of the selected AP model	Choose the option. <p>NOTE When this option is selected, some AP features are disabled to reduce power consumption, such as the USB port and one of the Ethernet ports.</p>
Internal Heater	Enables the heater that is built into the selected AP model	Select the Enable internal heaters (specific AP models only) check box.
USB Port	Disables the USB port. USB ports are enabled by default.	Select the Disable USB port check box.
Configuration > Advanced Options		
Location Based Service	Enables location-based service for the AP group.	<ul style="list-style-type: none"> • Select the Override zone configuration check box. • Select the Enable LBS Service check box. • Select an LBS Server from the drop-down.
Hotspot 2.0 Venue Profile	Indicates the hotspot profile that you want to assign to the group.	Select the required option or click Create and update the following details: <ul style="list-style-type: none"> • Enter the Name. • Enter the Description. • Enter the Venue Names. • Select the Venue Category. • Select the Type. • Enter the WLAN Metrics.

TABLE 10 AP Group Details (continued)

Field	Description	Your Action
AP Management VLAN	Indicates the AP management VLAN settings.	Choose the option. Click VLAN ID , and then type the VLAN ID that you want to assign (valid range is from 1 to 4094). To keep the same management VLAN ID that has been configured on the AP, click Keep AP's settings .
Auto Channel Selection	Indicates auto-channel settings.	Select the check box and choose the option.
Client Admission Control	Indicates the load thresholds on the AP at which it will stop accepting new clients.	Select the Override check box respective to 2.4 GHz Radio or 5 GHz Radio and update the following details: <ul style="list-style-type: none"> • Enable <p style="text-align: center;">NOTE Client load balancing and band balancing will be disabled for this AP group.</p> <ul style="list-style-type: none"> • Min Client Count • Max Radio Load • Min Client Throughput
Protection Mode	Indicates the mechanism to reduce frame collision.	Choose one of the following options: <ul style="list-style-type: none"> • None • RTS/CTS • CTS Only

NOTE

You can also edit, clone or delete an AP Group by selecting the options Configure , Clone  or Delete  respectively, from the Access Points page.

Configuring Model-Based Settings

If you want to apply a set of settings to all APs of a particular model, use the Model-Based Settings option.

Follow the steps to configure the model based settings.

1. From the left-pane, click **Access Points**. The Access Points page appears.
2. From the list, select the AP for which you want to apply the model-based settings and click **Configure**. The Edit AP form appears.
3. Scroll down to **Model Specific Options** section, and then expand the section.
4. In **Model Specific Control**, select the **Override zone config** check box. The settings available for the AP model appear.
5. In the General Options section, configure the following settings:

NOTE

The options that appear in the **Model Specific Options** section depend on the AP model that you select. Not all the options described in the table below will appear for every AP model.

Option	Description
USB Port	To disable the USB port on the selected AP model, select the Disable USB port check box. USB ports are enabled by default.
Status LEDs	To disable the status LED on the selected AP model, select the Disable Status LEDs check box.

Working With Access Points

Understanding the System, Domains, Zones and AP Groups

Option	Description
LLDP	To enable the Link Layer Discovery Protocol (LLDP) on the selected AP model, select the Enable Link Layer Discovery Protocol check box. <ul style="list-style-type: none"> Enter the Advertise Interval duration in seconds Enter the Hold Time duration in seconds Select the Enable Management IP TLV check box
PoE Operating Mode	Select the PoE operating mode of the selected AP model. Available options include Auto (default), 802.3af and 802.3at mode. If 802.3af PoE Operating Mode PoE is selected, this AP model will operate in 802.3af mode and will consume less power than in 802.3at mode. However, when this option is selected, some AP features are disabled to reduce power consumption, such as the USB port and one of the Ethernet ports.
PoE out port	To enable the PoE out port on the selected AP model, select the Enable PoE out ports (specific ZoneFlex AP models only) . <p>NOTE If the controller country code is set to United Kingdom, an additional Enable 5.8 GHz Channels option will be available for outdoor 11n/11ac APs. Enabling this option allows the use of restricted C-band channels. These channels are disabled by default and should only be enabled by customers with a valid license to operate on these restricted channels.</p>
Internal Heater	To enable the heater that is built into the selected AP model, select the Enable internal heaters (specific AP models only) check box.
External Antenna (2.4 GHz)	To enable the external 2.4 GHz antenna on the selected AP model, select the Enable external antenna check box, and then set the gain value (between 0 and 90dBi) in the box provided.
External Antenna (5 GHz)	To enable the external 5 GHz antenna on the selected AP model, select the Enable external antenna check box, and then set the gain value (between 0 and 90dBi) in the box provided.

6. In the **Port Settings** section, configure the following options for each LAN port.

NOTE

The number of LAN ports that appear in this section correspond to the physical LAN ports that exist on the selected AP model.

NOTE

When trunk port limitation is enabled, the controller does not validate the port settings configured in the AP or the AP group with no members.

Option	Description
Enable	Use this option to enable and disable this LAN port on the selected AP model. By default, this check box is selected. To disable this LAN port, clear this check box.
Profile	Use this option to select the Ethernet port profile that you want this LAN port to use. Two default Ethernet port profile exist: Default Trunk Port (selected by default) and Default Access Port . If you created Ethernet port profiles (see Creating an Ethernet Port Profile on page 230), these profiles will also appear on the drop-down list. <p>NOTE If you recently created an Ethernet port profile and it does not appear on the drop-down menu, click Reload on the drop-down menu to refresh the Ethernet port profile list.</p>
Overwriter VLAN	Select the check box and enter: <ul style="list-style-type: none"> Untag ID—Default: 1 Members—Range: 1 through 4094.

7. Click **OK**.

Supported LLDP Attributes

The Link Layer Discovery Protocol (LLDP) is a vendor-neutral Layer 2 protocol that allows a network device (for example, a Ruckus Wireless AP) to advertise its identity and capabilities on the local network.

LLDP information is sent by devices from each of their interfaces at a fixed interval (default is 30 seconds), in the form of an Ethernet frame. Each LLDP Ethernet frame contains a sequence of type-length-value (TLV) structures starting with Chassis ID, Port ID and Time to Live (TTL) TLV. Table 2 lists the LLDP attributes supported by the controller.

LLDP information is sent by devices from each of their interfaces at a fixed interval (default is 30 seconds), in the form of an Ethernet frame. Each LLDP Ethernet frame contains a sequence of type-length-value (TLV) structures starting with Chassis ID, Port ID and Time to Live (TTL) TLV. The following table lists the LLDP attributes supported by the controller.

Attribute (TLV)	Description
Chassis ID	Indicates the MAC address of the AP's br0 interface
Port ID	Identifies the port from which the LLDP packet was sent
Time to Live	Same as LLDP Hold Time. Indicates the length of time (in seconds) that a receiving device will hold the LLDP information sent by the selected AP model before discarding it. The default value is 120 seconds.
System Name	Indicates the name assigned to the AP. The default name of Ruckus Wireless APs is RuckusAP.
System Description	Indicates the AP model plus software version
System Capabilities	Indicates the AP's capabilities (Bridge, WLAN AP, Router, Docsis), and which capabilities are enabled
Management Address	Indicates the management IP address of the AP
Port Description	Indicates the description of the port in alphanumeric format

Configuring the Port Settings of a Particular AP Model

Use Port Settings in the AP Model-Specific Configuration section to configure the Ethernet ports of a particular AP model.

Follow these steps to configure the port settings of a certain AP model.

1. All ports are enabled by default (the Enable check boxes are all selected). To disable a particular port entirely, clear the Enable check box next to the port name (LAN1, LAN2, etc.)
2. For any enabled ports, you can choose whether the port will be used as a Trunk Port, Access Port, or General Port.

The following restrictions apply:

- All APs must be configured with at least one Trunk Port.

NOTE

You cannot move an AP model to an AP group and configure the AP model to use a trunk port at the same time, if general ports are enabled when trunk port limitation is disabled. You must configure the selected AP model to use at least one trunk port, and then move the AP model to the AP group.

- For single port APs, the single LAN port must be a trunk port and is therefore not configurable.
- For ZoneFlex 7025/7055, the LAN5/Uplink port on the rear of the AP is defined as a Trunk Port and is not configurable. The four front-facing LAN ports are configurable.
- For all other APs, you can configure each port individually as either a Trunk Port, Access Port, or General Port. See [Designating an Ethernet Port Type](#) on page 90 for more information.

Designating an Ethernet Port Type

Ethernet ports can be configured as access ports, trunk ports, or general ports.

Trunk links are required to pass VLAN information between switches. Access ports provide access to the network and can be configured as members of specific VLANs, thereby separating the traffic on these ports from traffic on other VLANs. General ports are user-defined ports that can have any combination of up to 20 VLAN IDs assigned.

For most ZoneFlex APs, you can set which ports you want to be your Access, Trunk and General Ports from the controller web interface, as long as at least one port on each AP is designated as a Trunk Port.

By default, all ports are enabled as Trunk Ports with Untag VLAN set as 1 (except for ZoneFlex 7025, whose front ports are enabled as Access Ports by default). If configured as an Access Port, all untagged ingress traffic is the configured Untag VLAN, and all egress traffic is untagged. If configured as a Trunk Port, all untagged ingress traffic is the configured Untag VLAN (by default, 1), and all VLAN-tagged traffic on VLANs 1-4094 will be seen when present on the network.

The default Untag VLAN for each port is VLAN 1. Change the Untag VLAN to:

- Segment all ingress traffic on this Access Port to a specific VLAN.
- Redefine the native VLAN on this Trunk Port to match your network configuration.

When trunk port limitation is disabled using the `eth-port-validate-one-trunk disable` command, validation checks are not performed for the VLAN members and the AP Management VLAN. If the AP configuration for general ports and access ports does not include a member of an AP management VLAN, or the VLAN of a WAN interface configured through CLI, the AP will disconnect and the Ethernet port stops transmitting data. Make sure that you configure the correct VLAN member in the ports (general/access) and the AP management VLAN.

NOTE

Ensure that at least one of the general port VLANs is the same as a Management VLAN of the AP.

Access Ports

Access ports provide access to the network and can be configured as members of a specific VLAN, thereby separating the traffic on these ports from traffic on other VLANs.

All Access Ports are set to Untag (native) VLAN 1 by default. This means that all Access Ports belong to the native VLAN and are all part of a single broadcast domain. When untagged frames from a client arrive at an AP's Access Port, they are given an 802.1Q VLAN header with 1 as their VLAN ID before being passed onto the wired network.

When VLAN 1 traffic arrives destined for the client, the VLAN tag is removed and it is sent as plain (untagged) 802.11 traffic. When any tagged traffic other than VLAN 1 traffic arrives at the same Access Port, it is dropped rather than forwarded to the client.

To remove ports from the native VLAN and assign them to specific VLANs, select Access Port and enter any valid VLAN ID in the VLAN ID field (valid VLAN IDs are 2-4094).

The following table describes the behavior of incoming and outgoing traffic for Access Ports with VLANs configured.

TABLE 11 Access Ports with VLANs configured

VLAN Settings	Incoming Traffic (from Client)	Outgoing Traffic (to Client)
Access Port, Untag VLAN 1	All incoming traffic is native VLAN (VLAN 1).	All outgoing traffic on the port is sent untagged.
Access Port, Untag VLAN [2-4094]	All incoming traffic is sent to the VLANs specified.	Only traffic belonging to the specified VLAN is forwarded. All other VLAN traffic is dropped.

Trunk Ports

Trunk links are required to pass VLAN information between switches. Trunking is a function that must be enabled on both sides of a link.

If two switches are connected together, for example, both switch ports must be configured as trunk ports.

The trunk port is a member of all the VLANs that exist on the AP/switch and carries traffic for all VLANs between switches.

For a trunk port, the VLAN Untag ID field is used to define the native VLAN - the VLAN into which untagged ingress packets are placed upon arrival. If your network uses a different VLAN as the native VLAN, configure the AP trunk port's VLAN Untag ID with the native VLAN used throughout your network.

General Ports

General ports are user-specified ports that can have any combination of up to 20 VLAN IDs assigned.

General ports function similarly to Trunk ports, except that where Trunk ports pass all VLAN traffic, General ports pass only the VLAN traffic that is defined by the user.

To configure an AP Ethernet port as a General port, select General Port and enter multiple valid VLAN IDs separated by commas or a range separated by a hyphen.

NOTE

You must also include the Untag VLAN ID in the Members field when defining the VLANs that a General port will pass. For example, if you enter 1 as the Untag VLAN ID and want the port to pass traffic on VLANs 200 and 300, you would enter: 1,200,300.

Configuring Client Admission Control

As an administrator, you can help maintain a positive user experience for wireless users on the network by configuring the following client admission control settings:

- Minimum client count
- Maximum radio load
- Minimum client throughput

Client admission control is implemented on a per radio basis and is supported on 802.11n and 802.11ac APs.

Monitoring Domains, Zones, and AP Groups

When you select a System, Domain, Zone, or AP Group from the hierarchy tree, respective contextual tabs appear at the bottom of the page.

These tabs are used to monitor the selected group. The following table lists the tabs that appear for System, Domain, Zone, and AP Group.

TABLE 12 System, Domain, Zone, and AP Groups Monitoring Tabs

Tabs	Description	System	Domain	Zone	AP Groups
General	Displays group information	Yes	Yes	Yes	Yes
Configuration	Displays group configuration information.	Yes	Yes	Yes	Yes
Health	Displays historical health information.	Yes	Yes	Yes	Yes
Traffic	Displays historical traffic information.	Yes	Yes	Yes	Yes
Alarm	Displays alarm information.	Yes	Yes	Yes	Yes
Event	Displays event information.	Yes	Yes	Yes	Yes

Working With Access Points

Understanding the System, Domains, Zones and AP Groups

TABLE 12 System, Domain, Zone, and AP Groups Monitoring Tabs (continued)

Tabs	Description	System	Domain	Zone	AP Groups
Clients	Displays client information.	Yes	Yes	Yes	Yes
WLANs	Displays WLAN information.	Yes	Yes	Yes	NA
Services	Displays information on the list of services.	Yes	Yes	Yes	NA
Administrators	Displays administrator account information.	Yes	NA	NA	NA

Additionally, you can select System, Domain, or Zone and click **More** to perform the following operations as required:

- **Move**
- **Create New Zone from Template**
- **Extract Zone Template**
- **Apply Zone Template**
- **Change AP Firmware**
- **Switchover Cluster**
- **Trigger Preferred Node**

Moving an AP Zone Location

Follow these steps to move an AP zone to a different location:

1. From the Access Points page, locate the AP zone that you want to move to a different location.
2. Click **Move**, the **Select Destination Management Domain** dialog box appears.
3. Select the destination and click **OK**, a confirmation dialog box appears.
4. Click **Yes**, the page refreshes and AP zone is moved to the selected destination.

Creating a New Zone using a Zone Template

Follow these steps to create a new zone using a template:

1. From the Access Points page, locate the zone from where you want to create a new zone.
2. Click **More** and select **Create New Zone from Template**, a dialog box appears.
3. In **Zone Name**, enter a name for the new AP zone.
4. Select the required template from the **Template Name** drop-down.
5. Click **OK**. The page refreshes and the new zone is created.

Extracting a Zone Template

You can extract the current configuration of a zone and save it as a zone template.

Follow these steps to extract the configuration of a zone to a zone template:

1. From the Access Points page, locate the zone from where you want to extract the WLAN template.
2. Click **More** and select **Extract Zone Template**, the **Extract Zone Template** dialog box appears.
3. In **Zone Template Name**, enter a name for the Template.
4. Click **OK**, a message appears stating that the zone template was extracted successfully.

5. Click **OK**. You have completed extracting a zone template.

The extracted Zone template can be viewed under **System > Templates > Zone Templates**.

Applying a Zone Template

You can apply an AP zone configuration template to a zone.

Follow these steps to apply a zone template:

1. From the Access Points page, locate the zone where you want to apply the zone template.
2. Click **More** and select **Apply Zone Template**, the **Import Zone Template** dialog box appears.
3. From the **Select a Zone template** drop-down, select the template.
4. Click **OK**, a confirmation message appears asking to apply the zone template to the AP zone.
5. Click **Yes**. The zone template was applied successfully.

You have completed applying zone template to the AP zone.

Changing the Zone's AP Firmware Version

The controller supports multiple firmware version. You can manually upgrade or downgrade the zone's AP firmware version.

Follow these steps to change the zone's AP firmware version:

1. From the Access Pointss page, locate the zone for which you want to upgrade the AP firmware version.
2. Click **More** and select **Change AP Firmware**, the **Change AP Firmware** dialog box appears.
3. The Current AP Firmware version is displayed. Select the firmware version you need. If you upgrade to a new firmware, a backup configuration file will be created. You can use this backup file to downgrade to original firmware.
4. Click **Yes**, a confirmation message appears stating that the firmware version was updated successfully.
5. Click **OK**. You have completed upgrading the zone's AP firmware version.

Rehomining Managed APs

Rehomining is the process of returning the APs that have failed over to the standby cluster back to their original cluster (once it becomes available). Rehomining must be done manually. APs that have failed over will continue to be managed by the failover cluster until you rehome them.

NOTE

To rehome managed APs, you must enable cluster redundancy so that the APs will continue to be managed by the failover cluster until you restore them to the original cluster (rehome) manually. See [Enabling Cluster Redundancy](#) on page 49.

Rehomining APs must be done on a per-cluster basis. Follow these steps to rehome managed APs to the original cluster.

1. From the Access Points page, select the **System** to activate rehome operation.
2. Click **More** and select **Rehome Primary Cluster** . A confirmation dialog box appears.
3. Click **Yes**, you have set active cluster to rehome.

Triggering a Preferred Node

You can trigger an AP that belongs to the current zone force go to their preferred node. For this, you must enable Node affinity, which gives AP the priority of preferred nodes.

Follow these steps to trigger a node:

NOTE

You must enable node affinity before triggering nodes.

1. From the Access Points page, locate the zone.
2. Click **More** and select **Trigger Preferred Node**, a confirmation stating that the node has been triggered appears.
3. Click **OK**. You have triggered the preferred node for the AP.

Viewing Modes



You can view System, Zone, and AP Group-level information by selecting one of the following **View Mode** options:

- **List**—Displays the list of all APs irrespective of the Zone or Group they belong.
- **Group**—Displays the list of APs in a hierarchy format. This is the default viewing mode.
- **Mesh**—Lists AP details.
- **Map**—Displays the location map of the APs.
- **Zone**—Lists zone details.

AP Status

The real-time status of the Access Points are classified as follows:

The status of Access Points can be one of the following:

-  **Online**—Number of Access Points that are online.
-  **Flagged**—Number of Access Points that are flagged.
-  **Offline**—Number of Access Points that are offline.

NOTE

APs that exceed their health threshold and that require your attention are flagged. See [Understanding Cluster and AP Health Icons](#) on page 22.

Configuring Access Points

You can configure an Access Point.

To configure an Access Point:

1. From the list, select the Access Point that you want to configure and click **Configure**. The Edit AP page appears.
2. Edit the parameters as explained in [Table 13](#).

3. Click **OK**.

NOTE

Select the **Override** check box if you want to configure new settings.

TABLE 13 Access Point Edit Parameters

Field	Description	Your Action
AP Configuration > General Options		
AP Name	Indicates the name of the AP.	Enter a name.
Description	Gives a short description of the AP.	Enter a short description.
Location	Indicates generic location.	Select the check box and enter the location.
Location Additional Information	Indicates specific location.	Select the check box and enter the location.
GPS Coordinates	Indicates the geographical location.	Select the option. For Manual option, enter the following details: <ul style="list-style-type: none"> • Latitude • Longitude • Altitude
User Location Information	Indicates the demographic information.	Enter the Area Code and Cell Identifier .
AP Admin Logon	Indicates the admin logon credentials.	Select the check box and enter the Logon ID and Password .
AP Configuration > Radio Options		
Channel Range (2.4G)	Indicates that you want to override the 2.4GHz channel range that has been configured for the zone to which this AP group belong.	Select Select Channel Range (2.4G) check boxes for the channels on which you want the 2.4GHz radios of managed APs to operate. Channel options include channels 1 to 11. By default, all channels are selected.
Channel Range (5G)	Indicates that you want to override the 5GHz channel range that has been configured for the zone to which this AP group belong.	Select Select Channel Range (5G) check boxes for the channels on which you want the 5GHz radios of managed APs to operate.
Radio Options b/g/n (2.4 GHz)	Indicates the radio option 2.4 GHz configurations.	Select the following options: <ul style="list-style-type: none"> • Channelization—Set the channel width used during transmission to either 20 or 40 (MHz), or select Auto to set it automatically. • Channel—Select the channel to use for the b/g/n (2.4GHz) radio, or select Auto to set it automatically. • TX Power Adjustment—Select the required option. • WLAN Group—Select the WLAN group to which this AP belongs. • WLAN Services—Select the check box to enable WLAN services in this radio.
Radio Options a/n/ac (5 GHz)	Indicates the radio option 5 GHz configurations.	Select the following options: <ul style="list-style-type: none"> • Channelization—Set the channel width used during transmission to either 20, 40, 80 (MHz), or select Auto to set it automatically. • Channel—Select the channel to use for the a/n/c (5GHz) radio, or select Auto to set it automatically.

TABLE 13 Access Point Edit Parameters (continued)

Field	Description	Your Action
		<ul style="list-style-type: none"> • TX Power Adjustment—Select the required option. • WLAN Group—Select the WLAN group to which this AP belongs. • WLAN Services—Select the check box to enable WLAN services in this radio.
AP Configuration > AP SNMP Options		
<p>NOTE For SCG200 controllers, AP SNMP Option is not supported.</p>		
Override zone configuration	Allows you to override the existing zone configuration	Select the check box
Enable AP SNMP	Enables you to configure SNMP settings.	Select the check box
SNMPv2 Agent	Allows you to add users to SNMPv2 Agent.	<ol style="list-style-type: none"> 1. Click Create and enter Community. 2. Select the required Privilege. If you select Notification enter the Target IP. 3. Click OK.
SNMPv3 Agent	Allows you to add users to SNMPv3 Agent.	<ol style="list-style-type: none"> 1. Click Create and enter User. 2. Select the required Authentication. 3. Enter the Auth Pass Phrase. 4. Select the Privacy option. 5. Select the required Privilege. If you select Notification select the option Trap or Inform and enter the Target IP. 6. Click OK.
AP Configuration > Model Specific Options		
Model Specific Control	Indicates that the model overrides the AP settings.	Select the check box.
USB Port	Disables the USB port on the selected AP model.	Select the option. USB ports are enabled by default.
Status LEDs	Disable the status LED on the selected AP model.	Select the option.
LLDP	Enables the Link Layer Discovery Protocol (LLDP) on the selected AP model.	Select the option and enter the following details: <ul style="list-style-type: none"> • Advertise Interval—Enter the duration in seconds. • Hold Time—Enter the duration in seconds. • Enable Management IP TLV—Select the check box.
PoE Operating Mode	Allows you to operate using PoE mode.	Select the option.
Port Settings	Indicates the port settings.	Select the option and choose the required LAN option.
AP Configuration > Advanced Options		
Network Settings	Determines the network settings.	Select the IPv4 Settings from the following: <ul style="list-style-type: none"> • Static—Enter the IP Address, Network Mask, Gateway, Primary DNS, Secondary DNS. • Dynamic

TABLE 13 Access Point Edit Parameters (continued)

Field	Description	Your Action
		<ul style="list-style-type: none"> • Keep the AP's Setting
Smart Monitor	Indicates AP interval check and retry threshold settings.	Select the required check boxes.
Syslog Options	Determines if external syslog server settings is applicable.	Select the required check boxes. For Enable external syslog server option, update the following information: <ul style="list-style-type: none"> • Server Address • Port • Facility for Event • Priority
Hotspot 2.0 version Profile	Indicates the hotspot profile that you want to assign to the group.	Select the required option or click Create and update the following details: <ul style="list-style-type: none"> • Enter the Name. • Enter the Description. • Enter the Venue Names. • Select the Venue Category. • Select the Type. • Enter the WLAN Metrics.
AP Management VLAN	Indicates the AP management VLAN settings.	Select the check box and choose the option.
Auto Channel Selection	Indicates auto-channel settings.	Select the check box and choose the option.
Client Admission Control	Indicates the load thresholds on the AP at which it will stop accepting new clients.	Select the check boxes and update the following details: <ul style="list-style-type: none"> • Min Client Count • Max Radio Load • Min Client Throughput
Swap Configuration		
Add Swap-In AP	Allows to swap APs.	Select the check box and enter the Swap-in AP MAC details.

NOTE

You can also move the location of an AP or delete an AP. To do so, select the AP from the list and click **Move** or **Delete** as required.

Managing Access Points

Overview of Access Point Configuration

Once you have created registration rules and the AP zones to which joining access points can be assigned automatically, access points will be able to join or register with the controller automatically.

After an access point registers successfully with the controller, you can update its configuration by following the steps described in this section.

Viewing Managed Access Points

After an access point registers successfully with the controller, it appears on the Access Points page, along with other managed access points.

Follow these steps to view a list of managed access points.

1. Click **Access Points**, a list of access points that are being managed by the controller appears on the Access Points page. These are all the access points that belong to all management domains.

The list of managed access points displays details about each access point, including its:

- AP MAC address
- AP name
- Zone (AP zone)
- Model (AP model)
- AP firmware
- IP address (internal IP address)
- External IP address
- Provision Method
- Provision State
- Administrative Status
- Status
- Configuration Status
- Registered On (date the access point joined the controller network)
- Registration Details
- Registration State
- Actions (actions that you can perform)

NOTE

By default, the Access Points page displays 20 access points per page (although you have the option to display up to 250 access points per page). If the controller is managing more than 20 access points, the pagination links at the bottom of the page are active. Click these pagination links to view the succeeding pages on which the remaining access points are listed.

2. To view access points that belong to a particular administration domain, click the name of the administration domain in the domain tree (on the sidebar).

The page refreshes, and then displays all access points that belong to that management domain.

Downloading the Support Log from an Access Point

If you are experiencing issues with an access point, Ruckus Wireless® Support may request you to download the support log from the access point.

The support log contains important technical information that may help Ruckus Wireless® Support troubleshoot the issue with the access point. Follow these steps to download the support log from an access point.

To download a support log from an AP:

- Select the AP and click **More > Download Support Log**. The following message appears: Do you want to open or save **SupportLog_{random-string}.log**.

Save the file and use a text editor (for example, Notepad) to view the contents of the text file. Send the support log file to Ruckus Wireless® Support, along with your support request.

Provisioning and Swapping Access Points

The controller supports the provisioning and swapping of access points.

As an administrator you can:

- Upload a file containing list of AP and the pre-provisioned configuration data for each AP. The controller processes the file and provides details on regarding the import results (including a list of failed APs and failure reasons).
- Modify or delete pre-provisioning data if AP does not connect to the controller
- Monitor the status and stage of the pre-provisioned APs
- Manually lock or unlock APs
- Upload a file containing list of AP pairs for swapping. The controller processes the file and provide the detailed import result (including a list of failed APs and failure reasons).
- Manually enter the AP swap pair
- Delete the swap configuration if AP fails to contact the controller
- Monitor the status and stage of the swapping AP pairs
- Manually swap the APs

Options for Provisioning and Swapping APs

The controller supports the provisioning and swapping of access points.

Use the following buttons on the AP List page to perform the AP provisioning and swapping.

- **Import Batch Provisioning APs:** Select this option to import the provisioning file. The controller displays the import results. Any errors that occur during the import process will be listed by the controller.
- **Export All Batch Provisioning APs:** Select this option to download a CSV file that lists all APs that have been provisioned. The exported CSV contains the following information:
 - AP MAC Address
 - Zone Name
 - Model
 - AP Name
 - Description
 - Location
 - GPS Coordinates
 - Logon ID
 - Password
 - Administrative State
 - IP Address
 - Network Mask
 - Gateway
 - Primary DNS

- Secondary DNS
- Serial Number
- IPv6 Address
- IPv6 Gateway
- IPv6 Primary DNS
- IPv6 Secondary DNS

NOTE

The exported CSV file for all batch provisioned APs only contains pre-provisioned APs. It does not contain swapping APs or auto discovered APs.

If no APs have been pre-provisioned, you will still be able to export the CSV file but it will be empty (except for the column titles).

- **Import Swapping APs:** Manually trigger the swapping of two APs by clicking the swap action in the row. You can also edit the pre-provision configuration only if the AP does not connect to the controller. Click the AP MAC address to bring up the configuration edit form, and then select Pre-provision Configuration.
- **Export All Batch Swapping APs:** Select this option to download a CSV file that lists all APs that have been swapped. The exported CSV contains the following information:
 - Swap In AP MAC
 - Swap In AP Model
 - Swap Out AP MAC

NOTE

The exported CSV file for batch swapping APs only contains swapping APs. It does not contain pre-provisioned APs or auto discovered APs.

Understanding How Swapping Works

The following table lists how the controller handles swapping by detailing each stage. For example, you have entered swap configuration as Swap In: A and Swap out: B.

TABLE 14 AP swapping stages

Stage	State A	Stage A	State B	Stage B
1. Enter data	Swapping	Not Registered	Approved	Waiting for swap in AP registration
2. AP register	Swapping	Waiting for swapping in	Approved	Waiting for swapping out
3. User swap	Approved	Swapped in	Swapping	Swapped out
4. Second swap	Swapping	Swapped out and waiting for swapping in	Approved	Swapped in and waiting for swapping out

Editing Swap Configuration

The controller supports the swapping or replacement of a managed AP with a new AP of the same model. This feature is useful when you want to avoid service interruption because you need to replace an AP in the field.

By configuring the swap settings, you can easily and automatically export and apply the settings of the old AP to the new AP.

Follow these steps to configure the swap settings of an AP.

1. On the Access Points page, locate the access point whose swap configuration you want to update.

2. Click **Configure**, the Edit AP page appears.
3. Click the **Swap Configuration** tab.
4. Select the **Add Swap-In AP** check box.
5. Enter the **Swap-In AP MAC** address.
6. Click **OK**.

You have completed editing the swap configuration.

Monitoring Access Points

When you select an AP from the list, contextual tabs appear at the bottom of the page.

The following table helps you to understand the real-time information about the AP.

TABLE 15 Access Point Monitoring Tabs

Tabs	Description
General	Displays group information
Configuration	Displays group configuration information.
Health	Displays historical health information.
Traffic	Displays historical traffic information.
Alarm	Displays alarm information.
Event	Displays event information.
Clients	Displays client information.
Pool Stats	Displays DHCP pool data.
Stats Counter	Displays AP statistics that can be exported to CSV format.

Additionally, you can select an AP and click **More** to perform the following operations as required:

- **Select ALL** - Selects all the APs in the list.
- **Deselect All**- Clears all selection from the list.
- **Troubleshooting > Client Connection** - Connects to client devices and analyze network connection issues in real-time. See, [Troubleshooting Client Connections](#) on page 267
- **Troubleshooting > Spectrum Analysis** - Troubleshoots issues remotely, identify sources of interferences within the network and allow administrators access to the RF health of the network environment. See, [Troubleshooting through Spectrum Analysis](#) on page 268
- **Restart** - Restarts an access point remotely from the web interface.
- **Lock** - Disables all WLAN services on the AP and disconnect all wireless users associated with those WLAN services temporarily.
- **Unlock** - Makes all WLAN services available.
- **Import Batch Provisioning APs** - Import the provisioning file. See, [Options for Provisioning and Swapping APs](#) on page 99
- **Import Swapping APs** - Manually trigger the swapping of two APs by clicking the swap action in the row. See, [Options for Provisioning and Swapping APs](#) on page 99
- **Export All Batch Provisioning APs** Downloads a CSV file that lists all APs that have been provisioned.. See, [Options for Provisioning and Swapping APs](#) on page 99
- **Export All Swapping APs** - Downloads a CSV file that lists all APs that have been swapped. See, [Options for Provisioning and Swapping APs](#) on page 99

- **Download Support Log** - Downloads support log.
- **Trigger AP Binary Log** - Triggers binary log for the selected AP.
- **Trigger Preferred Node** - Triggers an AP that belongs to the current zone to connect to the preferred node. See [Triggering a Preferred Node](#) on page 94.
- **Download CM Support Log** - Downloads Cable Modem support log.
- **Restart Cable Modem** - Restarts the cable modem. The AP will disconnect from the network for a short period. The AP will disconnect from the network for a short period.
- **Reset Cable Modem** - Resets the cable modem.
- **Reset Cable Modem to Factory Default** - Resets the cable modem to factory default settings.
- **Untag Critical APs** - Stating APs as non-critical. See, [Tagging Critical APs](#) on page 44.
- **Swap** - Swaps current AP to swap-in AP. See, [Editing Swap Configuration](#) on page 100
- **Approve** - Approves AP and completes registering. See, [Working with AP Registration Rules](#) on page 42.

Viewing Neighbor APs in a Non-Mesh Zone

To view neighbor APs in a Non-Mesh zone:

1. From the Access Points page, select an AP from the list which is not assigned to a Staging Zone.
2. Scroll down to the bottom of the page. In the Neighbors area, click **Detect**.

The list of neighboring APs are displayed in the table.

FIGURE 37 Neighbor APs for a Non-Mesh Zone

AP name	MAC Address	Status	Model	Zone Name	IPv4 Address	IPv6 Address	Channel(2.4G)	Channel(5G)
RuckusAP	F0:3E:90:3F:7F:80	Flagged	C110	430-ZONE-IPV6	N/A	2008::186	8 (20MHz)	44 (80MHz)
RuckusAP	F8:E7:1E:0C:A8:C0	Flagged	R310	ZONE-AB	140.138.80.126	N/A	4 (20MHz)	153 (80MHz)
RuckusAP	1C:89:C4:23:01:90	Online	H510	430-ZONE-IPV4	10.1.13.212	N/A	1 (20MHz)	161 (80MHz)
RuckusAP	F0:3E:90:3F:88:00	Online	R720	430-ZONE-IPV6	N/A	2008::226	11 (20MHz)	36 (80MHz)

- 3.

To refresh the list, click the Refresh  button.

Viewing AP Health Indicators

You can monitor the performance and connection failures of an AP from the Health tab page.

Performance

- **Latency** - It is the measurement of average delay required to successfully deliver a Wi-Fi frame.
- **Airtime Utilization** - It is a measurement of airtime usage on the channel measuring the total percentage of airtime usage on the channel.
- **Capacity** - It is a measurement of potential data throughput based on recent airtime efficiency and the performance potential of the AP and its currently connected clients.

Connection Failure

- Total - It is a measurement of unsuccessful connectivity attempts by clients.
- Authentication - It's a measurement of client connection attempts that failed at the 802.11 open authentication stage.
- Association - It is a measurement of client connection attempts that failed at the 802.11 association stage, which happens before user/device authentication.
- EAP - It is a measurement of client connection attempts that failed during an EAP exchange.
- RADIUS - It's a measurement of RADIUS exchange failures due to AAA client /server communication.
- DHCP - It's a measurement of failed IP address assignment to client devices.

To customize Health Performance settings:

1. From the Access Points page, select the required AP from the list.
2. Scroll Down and select the **Health** tab.
3. On the **Performance** bar, select the Setting  icon. The **Settings - Performance** pop-up appears. Customize the following:
 - **Show top**: Enter the number of performance failures to be displayed.
 - **Display Channel Change**: Select the required options. For example: **2.4G, 5G**.
 - **AP**: Choose how the AP details must be displayed. For example: **Name, MAC, IP**.
4. Click **OK**.

Performance details of the AP are listed according to the settings.

Viewing AP Traffic Indicators

You can monitor the performance and connection failures of an AP from the Traffic tab page.

You can view:

- Historical or Real Time traffic
- WLAN traffic

Traffic indicators can be filtered based on the following parameters:

- Rate, Packets, Rate
- Total, Downlink-From AP to client, Uplink-From client to AP

To customize Traffic settings:

1. From the Access Points page, select the required AP from the list.
2. Scroll Down and select the **Traffic** tab.
3. On the respective section bar, select the Settings  icon. The **Settings - Clients** pop-up appears. Customize the following:
 - **Type**: Choose the Display format. For example: **Chart, Table**.
 - **Display Channel Change**: Select the required options. For example: **2.4G, 5G**.

NOTE

This field is available only for the Clients Tab when you select the Display Type as Chart.

- **AP**: Choose the AP display format. For example: **Name, MAC, IP**.
4. Click **OK**.

Performance details of the AP are listed according to the settings.

Working with WLANs and WLAN Groups

- Domains, Zones, AP Groups, and WLANs.....105
- Viewing Modes.....105
- Creating a WLAN Domain for an MSP.....106
- WLAN Groups.....106
- Creating a WLAN Configuration.....107
- Managing WLANs.....123

Domains, Zones, AP Groups, and WLANs

If your wireless network covers a large physical environment (for example, multi-floor or multi-building office) and you want to manage and provide different WLAN services to different areas of your environment, you can virtually split them using the following hierarchy:

- Domains—Geographical grouping for regulatory operation.
- Zones—Comprises of multiple WLAN groups
- WLAN Groups—Comprises of multiple WLANs
- WLANs—Wireless network service

NOTE

In vSZ-H and SCG200, when the system is upgraded to release 3.5, the new UI and re-architected stats database will prevent the system from displaying AP and zone stats if the AP/zone is operating on 3.4 or prior releases. In order to make full use of the UI introduced in 3.5, zones and APs should be updated to 3.5 as well. Operationally, the zones will still work, but stats visibility will be impacted.

Viewing Modes

The **View Mode** on upper-right corner of the page provides two options to view the WLANs available in the system:

- **List**—Displays the list of all WLANs irrespective of the Zone or Group they belong.
- **Group**—Displays the list of WLANs that belong to a specific Zone or Group.



The following WLAN details can be viewed regardless of the mode selected:

- **Name**
- **Alert**
- **SSID**
- **Auth Method**
- **Encryption Method**
- **Clients**
- **Traffic**
- **VLAN**
- **Application Recognition**
- **Tunneled**

Creating a WLAN Domain for an MSP

A Managed Services Provider (MSP) manages and assumes a defined set of responsibility. You can create an MSP managed domain, to manage all their settings within that domain. You can also limit the number of APs per zone. Refer, [Limiting the Number of APs in a Domain or Zone on page 45](#).

To create a WLAN Domain for an MSP:

1. From the Wireless LANs Page, select **System** from the tree hierarchy.
2. Click the **Create**  button, the Create Group form appears.
3. Configure the following details:
 - a. Enter a **Name** for the domain.
 - b. Enter a **Description** about the domain.
 - c. By default, the **Type** selected is **Domain**.
 - d. The **Parent Group** displays the group to which this domain will be tagged.
 - e. In **Managed by Partner**, select the **Enable** check box.
4. Click **OK**. You have created a new WLAN domain. In the left pane, the new  MSP domain appears.

WLAN Groups

A WLAN group is a way of specifying which APs or AP groups provide which WLAN services. For example, if your wireless network covers three floors of a building and you need to provide wireless access to visitors only on the first floor:

1. Create a WLAN service (for example, **Guest Only Service**) that provides guest-level access only.
2. Create a WLAN group (for example, **Guest Only Group**), and then assign **Guest Only Service** (WLAN service) to **Guest Only Group** (WLAN group).
3. Assign APs on the 1st Floor (where visitors need wireless access) to your **Guest Only Group**.

Any wireless client that associates with APs assigned to the **Guest Only Group** will get the guest-level access privileges defined in your **Guest Only Service**. APs on the 2nd and 3rd floors can remain assigned to the default WLAN Group and provide normal-level access.



NOTE

- WLAN groups are configured at the zone level.
- Creating WLAN groups is optional. If you do not need to provide different WLAN services to different areas in your environment, you do not need to create a WLAN group.
- A default WLAN group called **default** exists. The first 27 WLANs that you create are automatically assigned to this default WLAN group.
- A WLAN group can include a maximum of 27 member WLANs. For dual radio APs, each radio can be assigned to only one WLAN group (single radio APs can be assigned to only one WLAN group).



Creating a WLAN Group

To create a WLAN group:

1. In the Wireless LANs page, from the **System** tree hierarchy, select the zone where you want to create a WLAN Group.



2. Click the add  button. The Create WLAN Group page appears.
3. Enter a **Name** and **Description** for the WLAN group.
4. From the **Available WLANs** list perform one of the following option:
 - select the required WLAN and click the Move button. It will appear in the **Selected WLANs** list.
 - click the add  button to create a new WLAN service. The Create WLAN Configuration page appears. Refer [Creating a WLAN Configuration](#) on page 107.

NOTE

To edit or delete a WLAN configuration, select the WLAN from the Available WLANs list and click Configure  or Delete  respectively.

5. Click **Next**, The Create WLAN Group form appears.
6. Click **OK**.

NOTE

You can also edit, clone, and delete WLAN group by selecting the options Configure , Clone , and Delete  respectively, from the Wireless LANs page.

Creating a WLAN Configuration

To create a WLAN configuration:

1. In the Wireless LANs page, as shown in [Figure 38](#), from the **System** tree hierarchy, select the **Zone** where you want to create a WLAN.

FIGURE 38 Wireless LANs

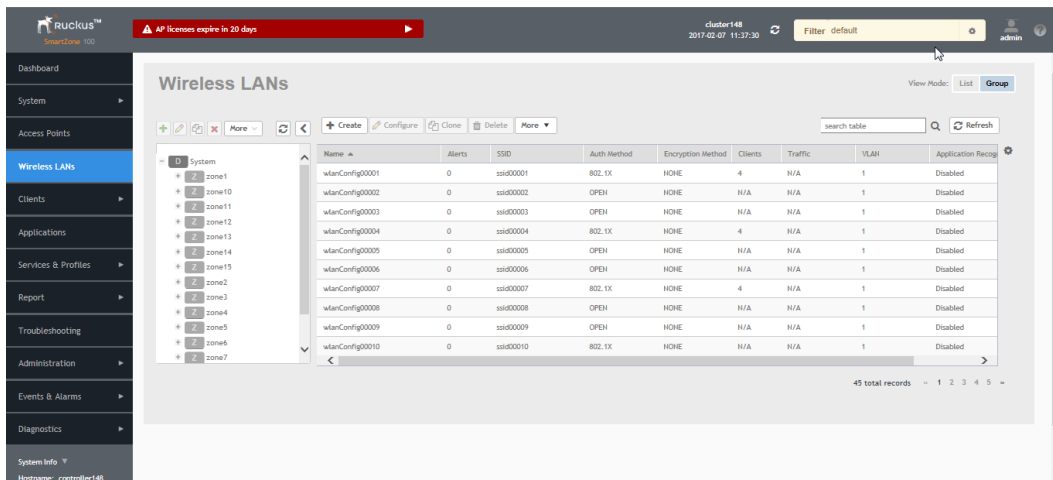

2. Click **Create**, [Figure 39](#) appears.

FIGURE 39 Create WLAN Configuration

Create WLAN Configuration

3. Set the required configurations as explained in [Table 16](#).
4. Click **OK**.

TABLE 16 WLAN Configurations

Field	Description	Your Action
General Options		
Name	Indicates the user-friendly administrative name for the WLAN.	Enter a name.
SSID	Indicates the SSID for the WLAN.	Enter the SSID
Description	Indicates a user-friendly description of the WLAN's settings or function.	Enter a short description.
Zone	Indicates the zone to which the WLAN configuration will apply.	Select the zone to which the WLAN settings apply.
WLAN Groups	Indicates the WLAN group(s) to which the WLAN applies.	Select the WLAN groups to which the WLAN configuration applies..
Authentication Options		
Authentication Type	Defines the type of authentication flow for the WLAN. NOTE Authentication types such as WeChat, Web Authentication and Guest Access are not supported by APs in IPv6 mode.	Select the required option: <ul style="list-style-type: none"> • Standard Usage—This is a regular WLAN suitable for most wireless networks. • Hotspot (WISPr)—Click this option if you want to use a hotspot service (use this type for external captive portal workflows) or WISPr. NOTE Hotspot (WISPr) applies to WLAN traffic that is tunneled and not tunneled.

TABLE 16 WLAN Configurations (continued)

Field	Description	Your Action
		<ul style="list-style-type: none"> • Guest Access—Click this option if you want guest users to use this WLAN. After you complete creating this WLAN for guest access, you can start generating guest passes. For more information about Hotspot 2.0 online signup, see the Hotspot 2.0 Reference Guide for this release. • Web Authentication—Click this option if you want to require all WLAN users to complete a web-based logon to this network every time they attempt to connect. • Hotspot 2.0 Access—Click this option if you want a Hotspot 2.0 operator profile that you previously created to use this WLAN. See the Hotspot 2.0 Reference Guide for this release. • Hotspot 2.0 Onboarding—Click this option if you want to use this WLAN for Hotspot 2.0 onboarding. See the Hotspot 2.0 Reference Guide for this release for more information. Hotspot 2.0 onboarding allows for Open and 802.1x EAP authentication methods. • WeChat—Click this option if you want the WLAN usage through WeChat.
Authentication Options		
Method	Specifies the authentication mechanism.	<p>Select the following option:</p> <ul style="list-style-type: none"> • Open (Default)—No authentication mechanism is applied to connections. If WPA or WPA2 encryption is used, this implies WPA-PSK authentication. If you clicked Web Authentication in Authentication Type, Open is the only available authentication option, even though PSK-based encryption can be supported. • 802.1x EAP—A very secure authentication/encryption method that requires a back-end authentication server, such as a RADIUS server. Your choice mostly depends on the types of authentication the client devices support and your local network authentication environment. If you select Enable RFC Location Delivery Support for Authentication & Accounting Server, enter the Operator Realm. Selecting the authentication method as Hotspot (WISPr), also allows you to select 802.1x EAP as an authentication option. This enables a two-step authentication method when shared and pre-authenticated devices are used, or when user equipment is shared among multiple users. The device access is successful when both authentication processes are completed successfully - 802.1x EAP authentication first, followed by Hotspot (WISPr) authentication. • 802.1x EAP with MAC address—Selecting this option indicates that the 802.1x EAP and MAC address authentication methods must both pass for a user to successfully authenticate. First, MAC address authentication is verified, if that passes, 802.1x EAP authentication is processed. After this two authentication methods succeed, the user equipment gains access to the WLAN. Authentication is done by a back-end RADIUS server.

TABLE 16 WLAN Configurations (continued)

Field	Description	Your Action
		<p>When this authentication method is selected, the MAC Authentication and MAC Address Format fields will be shown within the Authentication Options section.</p> <ul style="list-style-type: none"> • MAC Address—Authenticate clients by MAC address. <ul style="list-style-type: none"> – MAC Authentication—Requires a RADIUS server and uses the MAC address as the user logon name and password. <ul style="list-style-type: none"> › Select Use user defined text as authentication password (default is device MAC address) and enter the format. – MAC Address Format—Choose the MAC address format from the drop-down.
Encryption Options		
Method	<p>Specifies the encryption method. WPA and WPA2 are both encryption methods certified by the Wi-Fi Alliance; WPA2 with AES is the recommended encryption method. The Wi-Fi Alliance will be mandating the removal of WEP due to its security vulnerabilities, and Ruckus Wireless recommends against using WEP, if possible.</p>	<p>Select the option:</p> <ul style="list-style-type: none"> • WPA2—Enhanced WPA encryption using AES encryption algorithm. <ol style="list-style-type: none"> 1. Choose Algorithm: <ul style="list-style-type: none"> – AES: <ol style="list-style-type: none"> 1. Enter Passphrase. 2. Select or clear Show. 3. Select <ul style="list-style-type: none"> › the Enable 802.11 Fast BSS Transition check box and enter the Mobility Domain ID. › the required 802.11w MFP option. 4. Dynamic PSK <ul style="list-style-type: none"> › Disable › Internal <ul style="list-style-type: none"> ? Enter DPSK Length ? Choose DPSK Type ? Select DPSK Expiration › External—Enables Authentication Service – AUTO: <ol style="list-style-type: none"> 1. Enter Passphrase. 2. Select or clear Show. • WPA-Mixed—Allows mixed networks of WPA and WPA2 compliant devices. Use this setting if your network has a mixture of older clients that only support WPA and TKIP, and newer client devices that support WPA2 and AES. <ol style="list-style-type: none"> 1. Choose Algorithm: AES or AUTO. 2. Enter Passphrase. 3. Select or clear Show. 4. Select Enable 802.11 Fast BSS Transition. 5. Enter the Mobility Domain ID. 6. Dynamic PSK <ul style="list-style-type: none"> – Disable – Internal <ul style="list-style-type: none"> › Enter DPSK Length › Choose DPSK Type › Select DPSK Expiration

TABLE 16 WLAN Configurations (continued)

Field	Description	Your Action
		<ul style="list-style-type: none"> – External—Enables Authentication Service • WEP-64 (40 bits)—Provides a lower level of encryption, and is less secure, using 40-bit WEP encryption. <ol style="list-style-type: none"> 1. Choose the WEP Key. 2. Enter HEX value. • WEP-128 (104 bits)—Provides a higher level of encryption than WEP-64, using a 104-bit key for WEP encryption. However, WEP is inherently less secure than WPA. <ol style="list-style-type: none"> 1. Choose the WEP Key. 2. Enter HEX value. • None
Data Plane Options		
Access Network	<p>Defines the data plane tunneling behavior.</p> <p>In 3.6 SCG200-C is supported. SCG200-C is the SCG200 model without the internal DP functions. If Ruckus GRE tunnel is enabled, upgrade to SCG200-C is blocked and the following message appears: There exists a WLAN [WLAN_NAME] under Zone [ZONE_NAME] enable RuckusGRE tunnel</p>	<ul style="list-style-type: none"> • Select the check box to tunnel the data traffic to a central data plane. • Clear the check box if you want APs to perform local breakouts.
Core Network	Defines the network mode.	Select the option: <ul style="list-style-type: none"> • Bridge • L2oGRE
vSZ-D DHCP/NAT	Enables tunneling option for DHCP/NAT.	Select the required check boxes: <ul style="list-style-type: none"> • Enable Tunnel NAT • Enable Tunnel DHCP
RADIUS based DHCP/NAT	Enables RADIUS-based DHCP/NAT settings. DHCP server authorizes remote clients and allocates addresses based on replies from a RADIUS server.	Select the required check boxes: <ul style="list-style-type: none"> • Enable RADIUS based NAT • Enable RADIUS based DHCP
Authentication & Accounting Server (for WLAN Authentication Type: Standard usage)		
Authentication Server	Specifies the server used for authentication on this network. By enabling Proxy, authentication requests will flow through the controller. In a non-proxy mode, the AP will communicate directly with the authentication server without going through the controller.	<ol style="list-style-type: none"> 1. Select the check box. 2. Select the server from the drop-down menu. 3. Select the Enable RFC Location Delivery Support.
Accounting Server	Specifies the server used for accounting messages. By enabling Proxy, accounting messages are sent by the controller. In a non-proxy mode, the AP will communicate accounting messages directly.	<ol style="list-style-type: none"> 1. Select the check box. 2. Select the server from the drop-down menu.
Hotspot Portal (for WLAN Authentication Type: Hotspot (WisPr))		
Hotspot (WISPr) Portal	Defines hotspot behavior, like redirects, session timers, and location information, among others.	Select the hotspot portal profile that you want this WLAN to use.

TABLE 16 WLAN Configurations (continued)

Field	Description	Your Action
Bypass CNA	Bypasses the Apple CNA feature on iOS and OS X devices that connect to this WLAN.	Select the Enable check box.
Authentication Service	Indicates the authentication server that you want to use for this WLAN.	Choose the option. Options include Local DB , Always Accept , and any AAA servers that you previously added. Select: <ul style="list-style-type: none"> • Use Controller as Proxy for the controller to proxy authentication messages to the AAA server • Use Realm-based profile to list contents form the realm-based profile
Accounting Service	Indicates the RADIUS Accounting server that you want to use for this WLAN.	Choose the option. You must have added a RADIUS Accounting server previously. Select: <ul style="list-style-type: none"> • Use Controller as Proxy for the controller to proxy authentication messages to the AAA server • Use Realm-based profile to list contents form the realm-based profile
Guest Access Portal (for WLAN Authentication Type: Guest Access)		
Guest Portal Service	Indicates the guest access portal to be used on this WLAN.	Choose the guest portal service.
Bypass CNA	Bypasses the Apple CNA feature on iOS and OS X devices that connect to this WLAN.	Select the Enable check box.
Guest Authentication	Manages guest authentication.	Select: <ul style="list-style-type: none"> • Guest to require users to enter their guest pass credentials. Guest passes are managed directly on the controller. • Always Accept to allow users without guest credentials to authentication.
Guest Accounting	Indicates the RADIUS Accounting server that you want to use for this WLAN.	Choose the server. You must have added a RADIUS Accounting server previously. Additionally, if you want the controller to proxy accounting messages to the AAA server, select the Use the Controller as Proxy check box.
Authentication & Accounting Service (for WLAN Authentication Type: Web Authentication)		
Web Authentication Portal	Indicates the web authentication portal to use for this WLAN.	Choose the web authentication portal from the drop-down.
Bypass CNA	Bypasses the Apple CNA feature on iOS and OS X devices that connect to this WLAN.	Select the Enable check box.
Authentication Service	Indicates the authentication server that you want to use for this WLAN.	Choose the option. Options include Local DB , Always Accept , and any AAA servers that you previously added. Additionally, if you want the controller to proxy authentication messages to the AAA server, select the Use the Controller as Proxy check box.
Accounting Service	Indicates the RADIUS Accounting server that you want to use for this WLAN.	Choose the server. You must have added a RADIUS Accounting server previously. Additionally, if you want the controller to proxy accounting messages to the AAA server, select the Use the Controller as Proxy check box.
Hotspot 2.0 Profile (for WLAN Authentication Type: Hotspot 2.0 Access)		
Hotspot 2.0 Profile	Indicates the profile, which includes operator and identify provider profiles.	Choose the profile.
Authentication Service (RFC 5580)	Supports RFC 5580 location delivery on the WLAN, which carries location information in RADIUS exchanges.	Select the check box.

TABLE 16 WLAN Configurations (continued)

Field	Description	Your Action
Accounting Service (Updates)	Indicate the frequency to sends interim updates. Configure the account update interval for accounting servers defined in the Hotspot 2.0 Identity Provider profile.	Enter the duration in minutes. <i>Range:</i> 0 through 1440.
WeChat Portal (for WLAN Authentication Type: WeChat)		
WeChat Portal	Defines the WeChat authentication URL, DNAT destination, and other information.	Select a WeChat portal service.
Accounting Server	Indicates the RADIUS Accounting server that you want to use for this WLAN.	Choose the server. You must have added a RADIUS Accounting server previously. Additionally, if you want the controller to proxy accounting messages to the AAA server, select the Use the Controller as Proxy check box.
Forwarding Profile (for WLAN Usage > Access Network)		
Forwarding Policy	Defines special data packet handling to be taken by the data plane when the traffic is tunneled.	Forwarding Profile is Factory Default . It is disabled.
Options		
Wireless Client Isolation	Prevents wireless clients from communicating with each other	Click Enable to prevent wireless clients on the same VLAN/subnet from communicating with each other.
Isolation Whitelist	Defines wired destinations on the local subnet that can be reached, even if client isolation is enabled.	Select the option. NOTE Isolation Whitelist is not applicable for tunneled WLANs except in the vSZ-D platform.
Priority	Determines high vs low transmit preference of one WLAN compared to another. Traffic for high priority WLAN is always sent before low priority WLANs in the same QoS category (background, best effort, video, voice).	Choose the priority: <ul style="list-style-type: none"> • High • Low
RADIUS Option		
NAS ID	Defines the ID sent to the RADIUS server, which will identify the AP.	Choose the option: <ul style="list-style-type: none"> • WLAN BSSID • AP MAC • User-defined
NAS Request Timeout	Indicates the duration after which an expected RADIUS response message is considered to have failed.	Enter the timeout period (in seconds).
NAS MAX Number of Retries	Indicates the maximum number of failed connection attempts after which the controller will fail over to the backup RADIUS server.	Enter the maximum number of failed connection attempts.
NAS Reconnect Primary	Indicates the time interval after which the controller will recheck if the primary RADIUS server is available when the controller has failed over to the backup RADIUS server.	Enter the duration in minutes. <i>Range:</i> 1 through 60 minutes. The default interval is 5 minutes.
Called Station ID	Indicates the format for the called station ID, which is sent to the RADIUS server as an attribute, and can be used in policy decision	Select a format: <ul style="list-style-type: none"> • WLAN BSSID • AP MAC • AP GROUP

TABLE 16 WLAN Configurations (continued)

Field	Description	Your Action
		<ul style="list-style-type: none"> • NONE
Single Session ID Accounting	Enabling this feature allows the APs to maintain one accounting session for a client roaming between APs. If the client roams from one AP to another, the accounting session ID and stats will be carried while roaming from one AP to the other. If the feature is not enabled, the accounting session ID is re-generated and stats is also reset, essentially resetting the accounting session.	Select the Enable check box to use this feature.
NAS IP	Indicates the NAS IP address.	Select the option: <ul style="list-style-type: none"> • Disabled • SZ Control IP • SZ Management IP • User-defined
Advanced Options		
User Traffic Profile	Defines the traffic policy that will be applied to users on this WLAN. The default UTP allows all with no rate limits. UTPs can define rate limits as well as L3-7 ACLs and policies.	Select the required option.
L2 Access Control	Enables the WLAN to blacklist or whitelist a specific set of MAC addresses based on a L2 access control policy.	Select the required option.
OS Policy	Enables the WLAN to apply a unique policy to devices based on OS type. Use a precedence profile to determine whether a role-based, AAA-based, or OS-based policy will take precedence.	Select the required option.
Application Recognition and Control	Enables DPI-based L7 application recognition, and if enabled, an application control policy. Recognition and control are performed on the AP.	Select the Enable check box.
URL Filtering	Enables URL filtering on the WLAN controller to block or allow access to specific web sites or web pages.	Select the Enable check box.
Client Fingerprinting	Enables the AP to attempt utilize DHCP fingerprinting to identify client devices by their operating system, device type, and host name.	Select the check box.
Access VLAN	Tags the WLAN traffic with a VLAN ID between 2-4094. By default, all client traffic will be assigned to the native (untagged) VLAN on the AP's Ethernet port, which we represent as VLAN ID 1.	Select the check box and enter the VLAN ID .
Hotspot 2.0 Onboarding	Allows devices to connect to a WiFi network automatically, where in the service providers engage in roaming partnerships to provide seamless access to WiFi networks. The devices are authenticated using credentials or certificates.	Select the check box to allow Hotspot 2.0 Onboarding for the WISPr WLAN.

TABLE 16 WLAN Configurations (continued)

Field	Description	Your Action
Hide SSID	Removes the SSID from beacon frames. By removing the SSID, in most cases, clients will not show this SSID in their scan list unless the device is already configured to connect. This can simplify the network decision for an end user.	Select the check box.
Client Load Balancing	Disables client load balancing on this WLAN if the option is selected.	Select the check box to disable client load balancing on this WLAN.
Proxy ARP	Enables proxy ARP. When proxy ARP is enabled on a WLAN, the AP provides proxy service for stations when receiving neighbor discovery packets (for example, ARP request and ICMPv6 Neighbor Solicit messages), and acts on behalf of the station in delivering ARP replies. When the AP receives a broadcast ARP/ Neighbor Solicit request for a known host, the AP replies on behalf of the host. If the AP receives a request for an unknown host, it forwards the request.	Select the check box.
MAX Clients	Limits the number of clients that can associate with this WLAN per AP radio (default is 100). Every connection attempt after this max value will not be permitted to connect.	Enter the number of clients allowed.
802.11d	Adds additional regulatory information to AP beacons and probe responses. This compliance information provides country-specific guidance like permitted channels and transmit power, to ensure that the devices operate within the legal boundaries of the country. 11d is helpful for many devices that cannot independently determine their operating country.	Select the check box to enable this option.
802.11k Neighbor Report	Enhances roaming by providing a list of neighbor APs to the client device. APs build a neighbor AP list via background scanning, and when the client plans to roam, it will request this list from the AP. This list is then used to perform efficient scanning to find a roaming candidate.	Select the check box.
Force DHCP	Requires the clients to obtain a valid IP address from DHCP within the specified number of seconds. This prevents clients configured with a static IP address from connecting to the WLAN. Additionally, if a client performs Layer 3 roaming between different subnets, in some cases the client sticks to the former IP address. This mechanism optimizes the roaming experience by forcing clients to request a new IP address.	Select the check box.
DHCP Option 82	Enables an AP to encapsulate additional information (such as VLAN ID, AP name, SSID and MAC address) into the DHCP	Select the check box.

TABLE 16 WLAN Configurations (continued)

Field	Description	Your Action
	request packets before forwarding them to the DHCP server. The DHCP server can then use this information to allocate an IP address to the client from a particular DHCP pool based on these parameters.	
DHCP Option 82 Format	Enables an AP to encapsulate additional information (such as VLAN ID, AP name, SSID and MAC address) into the DHCP request packets before forwarding them to the DHCP server. The DHCP server can then use this information to allocate an IP address to the client from a particular DHCP pool based on these parameters.	Choose the required option: <ul style="list-style-type: none"> • Default • Option-A • Option-B
DTIM Interval	Indicates the frequency at which the DTIM (Delivery Traffic Indication Message) will be included in Beacon frames.	Enter the frequency number. Range: 1 through 255.
Directed MC/BC Threshold	Defines the per radio client count at which an AP stops converting group-addressed data traffic to unicast. However, the Directed Threshold logic is only one part of the access points' multicast handling logic, which means there may be other factors that determine whether a frame is transmitted as unicast or multicast. APs support a feature called Directed Multicast (configurable only on AP CLI, enabled by default), which adds additional logic to the multicast flow. If Directed Multicast is disabled, the AP uses the Directed Threshold as the only criteria to determine whether to transmit a multicast packet as unicast. However, when Directed Multicast is enabled, the flow is changed. Directed Multicast is a feature that checks to see if a multicast packet is well-known or not. For well-known multicast packets, for example: Bonjour, uPNP, most IPv6 link- and node-local, Spectralink, the AP still applies the directed-threshold logic to determine conversion to unicast. For non well-known types, the AP monitors and maintains a database of client subscriptions using IGMP and MLD. If associated clients are subscribed to the multicast stream, then the AP always converts these packets to unicast, regardless of the Directed Threshold configuration. If there are no clients subscribed to the multicast stream, the AP drops these packets. It is important to be aware of this behavior when validating multicast operation in a deployment.	Enter the client count number. Range: 0 through 128.
Client tx/Rx Statistics	Stops the controller from monitoring traffic statistics for unauthorized clients.	Select the check box.

TABLE 16 WLAN Configurations (continued)

Field	Description	Your Action
Inactivity Timeout	Indicates the duration after which idle clients will be disconnected.	Enter the duration in seconds.
OFDM Only	Disconnects 802.11b devices from the WLAN and all devices are forced to use higher data rates for more efficient airtime usage. This setting only affects the 2.4GHz radio. OFDM is used by 802.11a/g/n/ac, but is not supported by 802.11b.	Select the check box.
BSS Min Rate	Forces client devices to both be closer to the AP and to use higher, more efficient rates when you increase the BSS min rate above the default (all rates) setting. The BSS minimum rate is the lowest data rate supported on the WLAN. When OFDM-only is enabled, it takes higher priority than BSS min rate settings.	Select the option.
Mgmt Tx Rate	Sets the transmit rate for management frames type such as beacon and probes.	Select the value.
Service Schedule	<p>Controls when the WLAN service is active. The purpose of this setting is to automatically enable or disable a WLAN based on a pre-determined schedule. By default, the service is Always On. Always Off can be checked in order to create a WLAN and apply it, but prevent it from advertising until ready. The "specific" setting allows a configurable schedule based on time of day and days of the week.</p> <p>NOTE When a service schedule is created it is saved by the SZ and AP using the browser's time zone. When it is enforced by the AP, the AP will enforce it according to the time zone of the browser when it was configured.</p>	<p>Choose the option:</p> <ul style="list-style-type: none"> • Always On • Always Off • Specific and select a schedule profile from the drop-down list.
Band Balancing	Disables band balancing only for this WLAN, if you select the check box.	Select the Disable band balancing for this WLAN service check box.
Qos Map Set	<p>Reprioritizes downlink packets based on the configured mappings. When an AP receives a downlink packet, it checks the existing DSCP (L3 QoS) marking, compares it to this map set and then changes the user priority (L2 QoS) values for transmission by the AP.</p> <p>To configure this feature, select the User Priority (UP) from the table (0-7) and configure the DSCP (0-64) range that will be mapped to this UP.</p>	Select Enable QOS Map Set .

TABLE 16 WLAN Configurations (continued)

Field	Description	Your Action
	Exceptions can also be added such that the original DSCP and UP tagging are preserved the honored by the AP.	
SSID Rate Limiting	Enforces an aggregate rate limit for all users of the WLAN. The purpose of this feature is to prevent the combined throughput from all users of an SSID from exceeding this threshold. This feature is different from per-user rate limiting, which enforces the same rate limit for each individual device.	Select Uplink and Downlink check boxes and enter the limiting rate in mbps respectively. <i>Range:</i> 1 mbps through 200 mbps.
DNS Server Profile	Allows the AP to inspect DHCP messages and overwrite the DNS server(s) with the DNS server configured in this profile. This allows for policy-based DNS application in which unique users/roles should use a different DNS server than others.	Select a profile from the drop-down menu. Select Disable from the drop-down menu if you want to disable the DNS Server profile for the WLAN service.
Precedence Profile	Defines the relative policy assignment priority for some specific settings. For example, if a WLAN is configured to use VLAN 10, and a AAA/role policy is configured for VLAN 20, and a device OS policy is configured for VLAN 30, and a user/device connects to the WLAN matching all of these policies, which VLAN should be assigned. The precedence policy determines which setting takes priority.	Select the option.
CALEA (This feature is supported only for SZ300 controllers)	Intercepts traffic, a requirement enforced on some networks by government agencies. To utilize CALEA, you must support a vSZ-D and configure the CALEA settings in the Services & Profiles > Tunnels & Ports menu.	Select the check box.
Client Flow Data Logging	Sends a log message with source MAC, destination MAC, source IP, destination IP, source port, destination port, L4 protocol and AP MAC of each packet session to the external syslog server. This function is provided by the AP syslog client (not the SZ's syslog client), which must be enabled at the zone level in order to support this client flow logging.	Select the check box to log the client-flow data to the external syslog server. Then enable AP syslog functionality from the Zone settings.

For SCG200, SZ300 and vSZ-H, you can also migrate the WLAN configuration from a regular Domain to a Partner Domain. For more information, see <https://support.ruckuswireless.com/answers/000006414>

NOTE

You can also edit, clone and delete WLANs by selecting the options **Configure**, **Clone** and **Delete** respectively, from the Wireless LANs page.

802.11 Fast BSS Transition

802.11r Fast BSS Transition is a fast roaming protocol that reduces the number of frame exchanges required for roaming and allows the clients and APs to reuse the master keys obtained during a prior authentication exchange. 11r is most helpful for 802.1X networks. Client support is required for 11r to work.

802.11w MFP

802.11w Management Frame Protection provides additional security measures for management frames. Not all client devices support 802.11w.

Check your client devices before enabling 11w. If “Required” is selected, clients must support 11w in order to connect. If “Capable” is selected, clients with or without 11w should be able to connect. However, note that some clients with poor driver software may have connection problems even if 11w is set to Capable.

Band Balancing

Band balancing balances the client load on radios by distributing clients between the 2.4 GHz and 5 GHz radios.

This feature is enabled by default and set to a target of 25% of clients connecting to the 2.4 GHz band. To balance the load on a radio, the AP encourages dual-band clients to connect to the 5 GHz band when the configured percentage threshold is reached.

Bypassing Apple CNA

Some Apple® iOS and OS X® clients include a feature called Captive Network Assistant (CNA), which allows clients to connect to an open captive portal WLAN without displaying the logon page.

When a client connects to a wireless network, the CNA feature launches a pre-browser login utility and it sends a request to a success page on the Apple® website. If the success page is returned, the device assumes it has network connectivity and no action is taken. However, this login utility is not a fully functional browser, and does not support HTML, HTML5, PHP or other embedded video. In some situations, the ability to skip the login page for open WLANs is a benefit. However, for other guest or public access designs, the lack of ability to control the entire web authentication process is not desirable.

The controller provides an option to work around the Apple® CNA feature if it is not desirable for your specific deployment. With CNA bypass enabled, captive portal (web-based authentication) logon must be performed by opening a browser to any unauthenticated page (HTTP) to get redirected to the logon page.

Channel Mode

Channel mode is a method of statistically picking the most potent channel for an AP.

Some countries restrict certain 5GHz channels to indoor use only. For instance, Germany restricts channels in the 5.15GHz to 5.25GHz band to indoor use. When ZoneFlex Outdoor APs and Bridges with 5GHz radios (ZoneFlex 7762, 7762-S, 7762-T, 7761-CM and 7731) are set to a country code where these restrictions apply, the AP or Bridge can no longer be set to an indoor-only channel and will no longer select from amongst a channel set that includes these indoor-only channels when SmartSelect or Auto Channel selection is used, unless the administrator configures the AP to allow use of these channels.

For instance, if the AP is installed in a challenging indoor environment (such as a warehouse), the administrator may want to allow the AP to use an indoor-only channel. These channels can be enabled for use through the AP CLI or the controller web interface.

Client Admission Control

Client admission control allows APs to adaptively allow or deny the association of clients based on the potential throughput of the currently associated clients. This helps prevent APs from becoming overloaded with clients and improves user experience for wireless users.

As an administrator, you can help maintain a positive user experience for wireless users on the network by configuring the following client admission control settings:

- Minimum client count
- Maximum radio load
- Minimum client throughput

Client admission control is implemented on a per radio basis and is supported on 802.11n and 802.11ac APs.

Client Load Balancing

Enabling load balancing can improve WLAN performance by helping to spread the wireless client load between nearby access points, so that one AP does not get overloaded while another sits idle.

The load balancing feature can be controlled from within the controller web interface to balance the number of clients per radio on adjacent APs.

Adjacent APs are determined by the controller at startup by measuring the RSSI during channel scans. After startup, the controller uses subsequent scans to update the list of adjacent radios periodically and when a new AP sends its first scan report. When an AP leaves, the controller immediately updates the list of adjacent radios and refreshes the client limits at each affected AP.

Once the controller is aware of which APs are adjacent to each other, it begins managing the client load by sending the configured client limits to the APs. These limits are soft values that can be exceeded in several scenarios, including:

- When a client's signal is so weak that it may not be able to support a link with another AP
- When a client's signal is so strong that it really belongs on this AP.

The APs maintain these configured client limits and enforce them once they reach the limits by withholding probe responses and authentication responses on any radio that has reached its limit.

Key Points About Client Load Balancing

Before you enable load balancing, keep the following considerations in mind:

- The load balancing rules apply only to client devices; the AP always responds to another AP that is attempting to set up or maintain a mesh network.
- Load balancing does not disassociate clients already connected.
- Load balancing takes action before a client association request, reducing the chance of client misbehavior.
- The process does not require any time-critical interaction between APs and the controller.
- Provides control of adjacent AP distance with safeguards against abandoning clients.
- Can be disabled on a per-WLAN basis. For instance, on a voice WLAN, load balancing may not be desired due to voice roaming considerations.
- Background scanning must be enabled on the WLAN for load balancing to work.

Mobility Domain ID

A Mobility Domain ID is used by 802.11r to define a scope of the network in which an 11r fast roam is supported. Master keys are shared within the Mobility Domain, allowing clients to support a fast roam.

Portal-based WLANs

There are many types of portal-based WLANs and they can be distinguished based on where the user credentials are stored, and where the portal page is hosted.

TABLE 17 Portal-based WLANs

WLAN Type	User Credential	Portal on which WLAN is Hosted
Guest	Guest passes on the controller	AP
Hotspot (WISPr)	RADIUS server. LDAP/Active Directory from SmartZone release 3.2 and later	External portal server or internal portal on the controller
Web Auth	RADIUS/LDAP/Active Directory	AP

Guest and WebAuth WLAN portals are hosted on the controller AP with limited customization. WISPr WLANs are usually hosted on external portal servers providing the flexibility to customize. WISPr WLANs allow for sophisticated customization such as providing a customized login page which could include locale information, advertisements etc.

WISPr WLANs can also be configured to bypass the authentication portal such that if an end user device's MAC address (as a credential) is stored on a RADIUS server, there is no need to redirect the end user to the portal server for authentication.

Characteristics of portal-based WLANs

Portal-based WLANs have the following characteristics:

- WebAuth WLAN
 - Does not provide an option to modify the portal (WYSIWYG)
 - User authentication is done by the RADIUS server, LDAP and Active Directory
 - Allows redirecting user web pages
- Guest WLAN
 - Provides an option to modify the portal elements such as the logo, Terms and Conditions, title etc
 - User authentication is by using guest passphrases or select the **Always Accepted** option
 - Allows redirecting user web pages
 - Does not possess a local database, LDAP, Active Directory or RADIUS server
- Hotspot (WISPr) WLAN
 - Internal Portal
 - › Provides an option to modify the portal elements such as the logo, Terms and Conditions, title etc
 - › Allows redirecting user web pages
 - › User authentication is by the local database, LDAP, Active Directory, RADIUS server or rendered by selecting the **Always Accepted** option
 - › Supports the Walled Garden approach to allow user access to specific areas within the network
 - External Portal
 - › Allows customization of the portal pages through external services
 - › Supports Northbound Portal Interface for authentication
 - › User authentication is by the local database, LDAP, Active Directory, RADIUS server or rendered by selecting the **Always Accepted** option
 - › Supports the Walled Garden approach to allow user access to specific areas within the network
 - › Allows redirecting user web pages

Rate Limiting Ranges for Policies

You can define and apply rate limit values for user devices to control the data rate and types of network traffic the device transmits.

NOTE

For SmartZone release 3.4 and 3.2.x, the APs support the following rate limiting values:

- 0.10Mbps
- 0.25Mbps - 20.00Mbps (increments by 0.25Mbps)
- 21.00Mbps - 200.00Mbps (increments by 1.00Mbps)

For example, typing 6.45 Mbps maps to the closest predefined rate value, so 6.45Mbps will be rendered as 6.50Mbps.

NOTE

For SmartZone release 3.1.x, the APs support the following rate limiting values:

- 0.10Mbps
- 0.25Mbps - 20.00Mbps (increments by 0.25Mbps)
- 30.00Mbps
- 40.00Mbps
- 50.00Mbps

For example, typing 31.50 Mbps maps to the closest predefined rate value, so 31.50 Mbps will be rendered as 40 Mbps. Any rate greater than 50.00Mbps would be mapped to the maximum rate which is 50.00Mbps.

TABLE 18 Rate Limiting ranges for different controller policies

Policy	Global or Zone	Rate limit range for zone running SmartZone 3.4	Rate limit range for zone running SmartZone 3.2.x	Rate limit range for zone running SmartZone 3.1.x
Device Policy	Zone	0.1 Mbps to 200 Mbps Support uni-direction (Uplink and Downlink need not be enabled or disabled at the same time)	0.1 Mbps to 200 Mbps No support for uni-direction (Uplink and Downlink need not be enabled or disabled at the same time)	0.1 Mbps to 200 Mbps. But any rate greater than 50Mbps will be mapped to 50 Mbps implicitly on the AP side when the rate is applied. No support for uni-direction
User Traffic Profile	Global	0.1 Mbps to 200 Mbps No support for uni-direction because this is Global profile that is used by 3.2.x and 3.1.x APs	0.1 Mbps to 200 Mbps No support for uni-direction	But any rate greater than 50Mbps will be mapped to 50 Mbps implicitly on the AP side when the rate is applied. No support for uni-direction

Working with WLAN Schedule Profiles

A WLAN schedule profile specifies the hours of the day or week during which a WLAN service will be enabled or disabled.

For example, a WLAN for student use at a school can be configured to provide wireless access only during school hours. Create a WLAN schedule profile, and then when you configure a WLAN, select the schedule profile to enable or disable the WLAN service during those hours/days.

NOTE

This feature will not work properly if the system does not have the correct time. To ensure that the system always maintains the correct time, configure an NTP server and point the system to the NTP server's IP address, as described in [Configuring System Time](#) on page 34.

NOTE

WLAN service schedule times should be configured based on your browser's current timezone. If your browser and the target AP/WLAN are in different timezones, configure the on/off times according to the desired schedule according to your local browser. For example if you wanted a WLAN in Los Angeles to turn on at 9 AM and your browser was set to New York time, please configure the WLAN service schedule to enable the WLAN at noon. When configuring the service schedule, all times are based on your browser's timezone setting.

Creating a WLAN Schedule Profile

Follow these steps to create a WLAN schedule profile.

1. From the Wireless LANs page, select the WLAN for you want to create a WLAN Schedule profile.
2. Click **Configure**, the Edit WLAN Config page appears.
3. Scroll down to the Advanced Options section.
4. In the **Service Schedule** field, select **Specific**.
5. Click **Create**, the Create Time Schedules Table form appears.
6. In General Options, enter the **Schedule Name** and **Schedule Description**.
7. To set a WLAN schedule:
 - To enable or disable the WLAN for an entire day, click the day of the week under the **Time** column.
 - To enable or disable the WLAN for specific hour of a specific day, click the squares in the table. A single square represents 30 minutes (two-15 minute blocks).

Blue-colored cells indicate the hours when the WLAN is enabled. Clear (or white) cells indicate the hours when the WLAN is disabled.
8. Click **Create**, the page refreshes, and then the schedule you created appears in the drop-down list.

Managing WLANs

When you select a System, Domain, Zone, or WLAN Group from the hierarchy tree, respective contextual tabs appear at the bottom of the page.

These tabs are used to monitor the selected group. [Table 19](#) lists the tabs that appear for System, Domain, Zone, and WLAN Group.

TABLE 19 System/Domain/Zone/WLAN Groups Monitoring Tabs

Tabs	Description	System	Domain	Zone	WLAN Groups
Configuration	Displays the respective configuration information.	Yes	Yes	Yes	Yes
Traffic	Displays the respective historical traffic information.	Yes	Yes	Yes	Yes
Alarm	Displays the respective alarms information. See Managing Events and Alarms on page 297.	Yes	Yes	Yes	Yes
Event	Displays the respective event information. See Managing Events and Alarms on page 297.	Yes	Yes	Yes	Yes
APs	Displays the respective AP information. See Managing Access Points on page 97.	Yes	Yes	Yes	NA
Clients	Displays the respective client information. Refer Managing Clients .	Yes	Yes	Yes	NA

TABLE 19 System/Domain/Zone/WLAN Groups Monitoring Tabs (continued)

Tabs	Description	System	Domain	Zone	WLAN Groups
Services	Displays the respective Services information. See Services and Profiles on page 161.	Yes	Yes	Yes	NA
Administrators	Displays the respective administrator account information. See Administering the Controller on page 271.	Yes	NA	NA	NA

When you can select a Zone and click **More** you can perform the following operations:

- **Move**
- **Extract WLAN Template**
- **Apply WLAN Template**
- **Change AP Firmware**
- **Switchover Cluster**
- **Trigger Preferred Node**

Moving a Single WLAN to a Different WLAN Zone

Follow these steps to move a single access point from its current AP zone to a different one.

NOTE

The WLAN that you move will inherit the configuration of the new WLAN zone.

- From the Wireless LANs page, locate the WLAN zone that you want to move to a different WLAN zone.
- Click **More** and select **Move**, the **Select Destination Management Domain** dialog box appears.
- Select the destination WLAN zone.
- Click **OK**, a confirmation message appears.
- Click **Yes**. The WLAN zone is moved to the destination location.

Extracting a WLAN Template

You can extract only WLAN-related configuration of an AP to a WLAN template.

Follow these steps to extract a WLAN template:

1. From the Wireless LANs page, locate the zone from where you want to extract the WLAN template.
2. Click **More** and select **Extract WLAN Template**, the Extract WLAN Template form appears.
3. In **WLAN Template Name**, enter a name for the Template.
4. Click **OK**, a message appears stating that the WLAN template was extracted successfully.
5. Click **OK**. You have completed moving an access point to a new AP zone.

The extracted WLAN template can be viewed under **System > Templates > WLAN Templates**.

Applying a WLAN Template

You can apply only WLAN-related configuration to an AP zone using a WLAN template.

Follow these steps to apply a WLAN template:

1. From the Wireless LANs page, locate the zone where you want to apply the WLAN template.
2. Click **More** and select **Apply WLAN Template**, the **Apply WLAN Template** dialog box appears.
3. From the **Select a WLAN template** drop-down, select the template.
4. Click **OK**, a confirmation message appears asking to apply the wlan templates to the zone.
5. Click **Yes**, a confirmation message appears stating the template was applied successfully.

You have completed applying WLAN template to the AP zone.

Triggering a Preferred Node

You can trigger an AP that belongs to the current zone force go to their preferred node. For this, you must enable Node affinity, which gives AP the priority of preferred nodes.

Follow these steps to trigger a node:

NOTE

You must enable node affinity before triggering nodes.

1. From the Wireless LANs page, locate the zone.
2. Click **More** and select **Trigger Preferred Node**, a confirmation dialog box appears.
3. Click **OK**. You have triggered the nodes in the AP zone.

Managing Clients

- Working with Wireless Clients..... 127
- Working with Wired Clients..... 130
- Working with Users and Roles..... 131
- Working with Guest Passes..... 137
- Working with Dynamic PSKs..... 150

Working with Wireless Clients

Wireless clients are client devices that are connected to the wireless network services that your managed APs provide. Wireless clients can include smart phones, tablets, and notebook computers equipped with wireless network adapters.

Viewing a Summary of Wireless Clients

View a summary of wireless clients that are currently associated with all of your managed access points.

Go to **Clients > Wireless Clients**. The **Wireless Clients** page appears and displays a table that lists all clients that are currently associated with your managed access points.

To view only wireless clients that belong to a particular zone, click the zone name in the zone tree. The table refreshes and displays only the clients that belong to the zone you selected.

The following table lists the wireless client details.

NOTE

Not all of the columns listed below are displayed by default. To display column that are currently hidden, click the gear icon in the upper-right corner of the table, and then select the check boxes for the columns that you want to display.

You can view the clients listed in the table in two view modes - **No TTG** (without TTG) and **TTG** (with TTG).



Click the  icon to export all the data into a CSV file.

TABLE 20 Wireless client details

Column Name	Description
Hostname	Displays the hostname of the wireless client
OS Type	Displays the operating system that the wireless client is using
IP Address	Displays the IP address assigned to the wireless client
MAC Address	Displays the MAC address of the wireless client
WLAN	Displays the name of the WLAN with which the client is associated
AP Name	Displays the name assigned to the access point
AP MAC	Displays the MAC address of the AP
Traffic (Session)	Displays the total traffic (in KB/MB/GB/TB) for this client in this session
Traffic (Uplink)	Displays the total uplink traffic (in KB/MB/GB/TB) for this client in this session
Traffic (Downlink)	Displays the total downlink traffic (in KB/MB/GB/TB) for this client in this session

Managing Clients

Working with Wireless Clients

TABLE 20 Wireless client details (continued)

Column Name	Description
RSSI	Displays the Received Signal Strength Indicator (RSSI), which indicates how well a wireless client can receive a signal from an AP. The RSSI value is shown in decibels (dB) and displayed as either the real-time value or the average value over the past 90 seconds.
SNR	Displays the Signal-to-Noise Ratio (SNR), which indicates the signal strength relative to background noise. The SNR value is shown in decibels (dB) and displayed as either the real-time value or the average value over the past 90 seconds.
Radio Type	Displays the type of wireless radio that the client supports. Possible values include 11b, 11g, 11g/n, 11a, 11a/g/n, and 11ac.
VLAN	Displays the VLAN ID assigned to the wireless client
Channel	Displays the wireless channel (and channel width) that the wireless client is using
User Name	Displays the name of the user logged on to the wireless client
Connected Since	Displays the time from which the AP is connected to the wireless client
# of Events	Displays the number of client events
Data Rate (Up)	Displays the rate at which data is transmitted from the wireless client to the AP
Data Rate (Down)	Displays the rate at which data is transmitted from the AP to the wireless client
Auth Method	Displays the authentication method used by the AP to authenticate the wireless client
Auth Status	Indicates whether the wireless client is authorized or unauthorized to access the WLAN service
Encryption	Displays the encryption method used by the AP
Control Plane	Displays the name of SmartZone node to which the AP's control plane is connected
Packets to	Displays the downlink packet count for this session
Packets from	Displays the uplink packet count for this session
Packets dropped	Displays the downlink packet count for this client that have been dropped

Viewing Information about a Wireless Client

You can view more information about a wireless client, including its IP address, MAC address, operating system, and even recent events that have occurred on it.

Follow these steps to view information about a wireless client.

1. Go to **Clients > Wireless Clients**.
2. From the list of wireless clients, locate the client whose details you want to view.
3. Under the **MAC Address** column, click the MAC address of the wireless client.

The **Associated Client** page appears and displays general information about the wireless client.

- **General:** Displays general client information.
- **Health:** Displays information about the real-time health of the client. It displays graphical trends based on the signal-to-noise ratio (SNR) and data rate. You can use the **Start** and **Stop** option to review client health at real time.
- **Traffic:** Displays historical and real-time traffic information.
- **Event:** Displays information about events associated with the client.

Deauthorizing a Wireless Client

If you want to force wireless clients that joined the wireless network through an authentication portal (for example, a hotspot, guest access or web authentication portal) to reauthenticate themselves, you can deauthorize them. Deauthorized wireless clients remain connected to the wireless network, but these clients will be redirected to the authentication portal whenever they attempt to access network resources.

Follow these steps to deauthorize a wireless client.

1. On the menu, click **Clients > Wireless Clients**.
2. From the list wireless clients, locate the client that you want to deauthorize. If you have a large number of wireless clients and you know the MAC address of the client, enter the MAC address in the search box, and then press Enter to search for the client.
3. When you have located the client, select it, and then click the **Deauthorize** button above the table.

The table refreshes, and then the client that you deauthorized disappears from the list.

Blocking a Wireless Client

When a user associates a wireless client device with an AP that the controller is managing, the client device is recorded and tracked. If, for any reason, you need to block a client device from accessing the network, you can do so from the web interface.

A few reasons why you might consider blocking a wireless client device include:

- Network abuse
- Violation of acceptable use policy
- Theft
- Security compromise

Follow these steps to block a wireless client from accessing the SmartZone network.

1. On the menu, click **Clients > Wireless Clients**.
2. From the list wireless clients, locate the client that you want to block. If you have a large number of wireless clients and you know the MAC address of the client, enter the MAC address in the search box, and then press <Enter> to search for the client.
3. When you have located the client, select it, and then click the **Block** button above the table.

You have completed blocking a wireless client.

Unblocking a Wireless Client

If you want to allow a client that you previously blocked to access the SmartZone network, you can unblock it.

Follow these steps to unblock a wireless client.

1. On the menu, click **Services and Profiles > Access Control**.
2. Click the **Blocked Client** tab.
3. From the list of blocked clients, locate the client that you want to unblock. If you have a large number of blocked clients and you know the MAC address of the client, enter the MAC address in the search box, and then press <Enter> to search for the client.
4. When you have located the client, select it, and then click the **Delete** button above the table.

The table refreshes, and then the client that you want to unblock disappears from the list.

You have completed unblocking a wireless client.

Disconnecting a Wireless Client

If you need to temporarily disconnect a wireless client from the wireless network, you can do so from the web interface. For example, if you are troubleshooting problematic network connections, you might have to manually disconnect wireless clients as part of the troubleshooting process.

Follow these steps to disconnect a wireless client from the WLAN to which it is connected.

1. On the menu, click **Clients > Wireless Clients**.
2. From the list wireless clients, locate the client that you want to disconnect. If you have a large number of wireless clients and you know the MAC address of the client, enter the MAC address in the search box, and then press <Enter> to search for the client.
3. When you have located the client, select it, and then click the **Disconnect** button above the table.

The table refreshes, and then the client that you disconnected disappears from the list.

Working with Wired Clients

Wired clients are client devices that are connected to the Ethernet ports of APs managed by the controllers, and thereby are connected to the wired network services that your managed APs provide.

Viewing a Summary of Wired Clients

View a summary of wired clients that are currently associated with all of your managed access points.

Go to **Clients > Wired Clients**. The **Wired Clients** page appears and displays a table that lists all clients that are currently associated with your managed access points.

To view only wired clients that belong to a particular zone, click the zone name in the zone tree. The table refreshes and displays only the clients that belong to the zone you selected.

The following table lists the wired client details.

TABLE 21 Wired client details

Column Name	Description
MAC Address	Displays the MAC address of the wired client
Username	Displays the name of the user logged on to the wire client
IP Address	Displays the IP address assigned to the wired client
AP MAC	Displays the MAC address of the AP
AP Name	Displays the name assigned to the access point
LAN	Displays the LAN ID assigned to the wired client
VLAN	Displays the VLAN ID assigned to the wired client
Auth Status	Indicates whether the wired client is authorized or unauthorized to access the WLAN service

Viewing Information about a Wired Client

You can view more information about a wired client, including its IP address, MAC address and even recent events that have occurred on it.

Follow these steps to view information about a wired client.

1. Go to **Clients > Wired Clients**.

2. From the list of wired clients, locate the client whose details you want to view.
3. Under the **MAC Address** column, click the MAC address of the wired client.

The **Associated Client** page appears and displays general information about the wired client.

- General: Displays general client information.
- Event: Displays information about events associated with the client.

Deauthorizing a Wired Client

If you want to force wired clients that joined the wired network through an authentication portal to reauthenticate themselves, you can deauthorize them. Deauthorized wired clients remain connected to the wired network, but these clients will be redirected to the authentication portal whenever they attempt to access network resources.

Follow these steps to deauthorize a wired client.

1. On the menu, click **Clients > Wired Clients**.
2. From the list wired clients, locate the client that you want to deauthorize. If you have a large number of wired clients and you know the MAC address of the client, enter the MAC address in the search box, and then press **Enter** to search for the client.
3. When you have located the client, select it, and then click the **Deauthorize** button above the table.

The table refreshes, and then the client that you deauthorized disappears from the list.

Working with Users and Roles

The controller provides a default role (named **Default**) that is automatically applied to all new user accounts.

By default, this role links all users to the internal WLAN and permits access to all WLANs. As an alternative, you can create additional roles that you can assign to select wireless network users, to limit their access to certain WLANs, to allow them to log on with non-standard client devices, or to grant permission to generate guest passes. (You can then edit the default role to disable the guest pass generation option.)

Creating a User Role

Use user roles to limit user access to certain WLANs, to allow them to log on with non-standard client devices.

Follow these steps to create a user role.

1. Go to **Clients > Users & Roles**.
2. Select the **User Roles** tab, and then select the zone for which you want to create the role.

3. Click **Create**.

The **Create User Role** page appears.

FIGURE 40 Create User Role

Create User Role

* Role Name:

Description:

* User Traffic Profile:

Access VLAN: VLAN ID

Enable VLAN Pooling

4. Configure the options in the **Create User Role** form.

- Role Name: Type a name for this user role.
- Description: Type a description for this user role.
- User Traffic Profiles: Select the user traffic profile from the drop-down menu. You can also create the user traffic profile. For more information, see [Creating a User Traffic Profile](#) on page 177.
- Access VLAN: Provide the VLAN ID.

You can also select the Enable VLAN Pooling check-box and select the VLAN ID from the drop-down list. You can also create a VLAN Pooling profile. For more information, see [Creating a VLAN Pooling Profile](#) on page 182.

5. Click **OK**.

You have completed creating a user role.

NOTE

You can also edit, clone and delete user roles by selecting the options **Configure**, **Clone** and **Delete** respectively, from the **User Roles** tab.

Creating a User Role with Active Directory Authentication

Configuring user roles using AD authentication provides broad range of directory-based identity-related services.

To create a User Role with AD authentication:

1. Create a new UTP for a particular role, refer [Creating a User Traffic Profile](#).
2. Create a role, refer [Creating a User Role](#).

3. **NOTE**
Non-proxy Auth servers are not supported.

Create a new Proxy AD server and apply the UTP. Refer [Creating Proxy AAA Servers](#).

4. **NOTE**
In step 4 of the authentication test, for the **Service Protocol** option, choose **Active Directory** and proceed.

Perform an authentication test to ensure that the user gets assigned the correct Role. Refer [Testing AAA Servers](#).

5. Create a web authentication portal WLAN configuration and assign the Non-proxy AD server to it. Refer [Creating a WLAN Configuration](#).
 - a) Choose **WLAN Usage > Authentication Type > Web Authentication**.
 - b) Configure the following for **Authentication & Accounting Server**:
Web Authentication Portal: choose the option from the drop-down.
Authentication Server: select the Use the Controller Proxy check box and choose the authentication service from the drop-down.

Creating a User Role with 802.1x Authentication

To create a User Role with 802.1x authentication:

1. Create a new UTP for a particular role, refer [Creating a User Traffic Profile](#).
2. Create a role, refer [Creating a User Role](#).

3. **NOTE**
Non-proxy Auth servers are not supported.

NOTE
In step 4 of this procedure, for the **Service Protocol** option, choose **RADIUS** and proceed.

Create a new Proxy RADIUS server and apply the UTP. Refer [Creating Proxy AAA Servers](#).

4. Perform an authentication test to ensure that the user gets assigned the correct Role. Refer [Testing AAA Servers](#).
5. Create a web authentication portal WLAN configuration and assign the Non-proxy RADIUS server to it. Refer [Creating a WLAN Configuration](#).
 - a) Choose **WLAN Usage > Authentication Type > Web Authentication**.
 - b) Go to **Authentication Options > Methods**, choose **802.1x EAP** and proceed.

Limitations Applying Role Policies to Users

You must be aware of some limitations in applying roles to a user.

- Role-based policies are only supported in proxy-mode AAA WLANs, where proxy AAA method is used for authentication. If the authentication method is non-proxy AAA, where the AP authenticates the user, the user equipment (UE) cannot be determined and therefore, user-role policies are not supported on non-proxy mode AAA WLANs.
- Typically, the RADIUS/AAA servers return a user attribute to the controller, and the controller assigns it to an UE. However, you must establish a mapping between the user attribute and the user role, so that the user role policy can be applied to the UE. The attribute-role mapping is configured within the AAA policy.

Managing Clients

Working with Users and Roles

- User Traffic Profiles are configured with various policies such as rate limiting so when a profile is applied to a WLAN, the policies in the profile are applied to all the UEs in the WLAN. The policies can also be applied to a user role in a WLAN, but not all the policies defined in the profile are applied to the role.

If a role-based VLAN policy is defined in the profile, it cannot be applied to the WLAN if its authenticated based on a L7 method (WebAuth or Hotspot/WISPr). This is because when a VLAN is applied on a per-role basis for a L7 authentication method, the user receives an IP address via DHCP before the UE is authenticated - this happens at layer 3 or 4, and you cannot authenticate the UE and assign a role to it till layer 7 is reached. This results in a mismatch between the VLAN IDs set within the roles, and could possibly lead to service disruptions.

- Precedence profiles are configured at the WLAN level, but impact the manner in which roles are assigned. The manner in which the profile is defined, indicates the order in which policies defined within the profile are assigned. The order of priorities can be customized. For example, if you have WLAN5 configured with VLAN ID 5, An OS policy configured with an iOS VLAN ID 10, and a role policy assigned to a student with VLAN ID 40, then there are multiple orders one can set when a *student user with iOS connects to WLAN 5*.
- You can assign a UE to a role through RADIUS, or you can use RADIUS attributes to apply policies. However, using RADIUS attributes take precedence over assigning UEs to a role (though it is easy to configure, as the only element required to authenticate the UE is the role information).

In the RADIUS attributes method, each policy, such a rate limiting or user traffic profile has a unique RADIUS attribute. Therefore, specifying the RADIUS attribute for a policy will override all other forms of the controller policy. For example, if a UE is already assigned to VLAN 7 through RADIUS, setting a RADIUS attribute for VLAN IDs to 9 will override all VLAN=7 configurations in say WLANs, OS policies, role policies etc.

Creating a Local User

A local user in the controller refers to a registered user who may be given access to the controller hotspot. A user account contains a user's personal information, logon information, and the subscription package that he or she has been assigned. The controller's local user database can include 802.1X, WISPr, and Zero-IT users.

When you create a user account, you will be required to assign a subscription package to the user. Before creating a user account, Ruckus Wireless® recommends creating at least one subscription package. See [Creating a VLAN Pooling Profile](#) on page 182 for more information.

1. Go to **Clients > Users & Roles**.
2. Select the **Local Users** tab, and then select the zone for which you want to create the local user.

3. Click **Create**.
The **Create User** page appears.

FIGURE 41 Create User

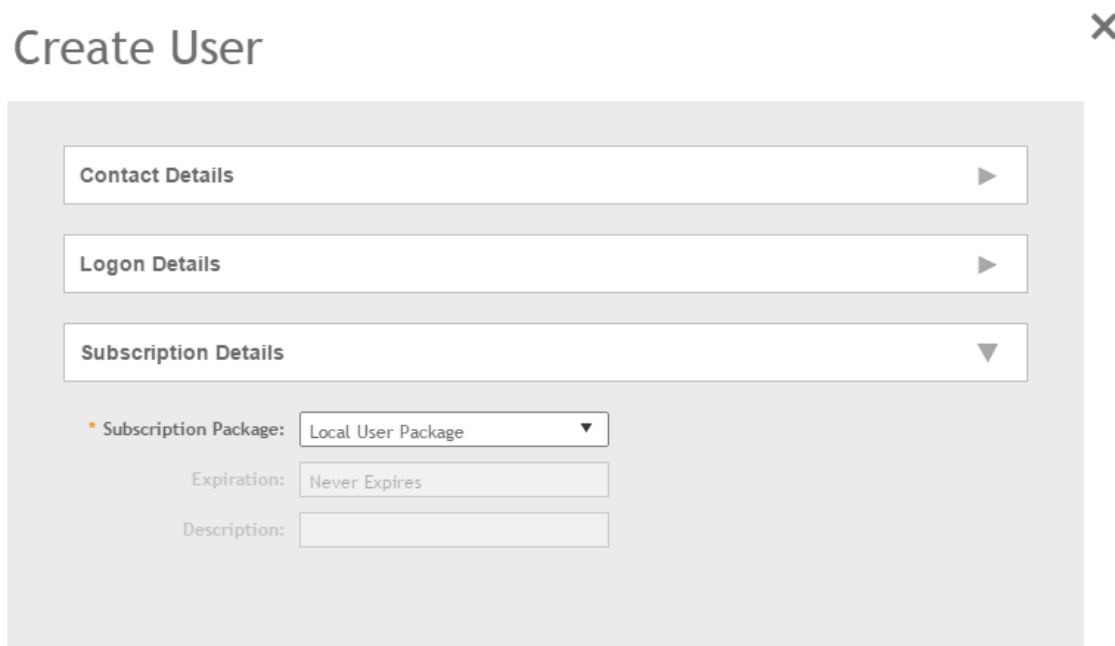

The screenshot shows the 'Create User' form with the following visible elements:

- Section: **Contact Details** (collapsed)
- Section: **Logon Details** (collapsed)
- Section: **Subscription Details** (expanded)
 - Subscription Package: Local User Package (dropdown)
 - Expiration: Never Expires (text field)
 - Description: (empty text field)

4. Configure the options in the **Create User** form.
 1. In the **Contact Details** section, fill the following:
 - First Name
 - Last Name
 - Email
 - Phone
 - Address
 - City
 - State
 - Zip Code
 - Country
 - Remark
 2. In the **Login Details** section, fill out the following boxes to create the logon credentials of this user:
 - User Name: Type a name for this user. The user name is not case-sensitive and will always be displayed in lowercase characters.
 - Password: Type a password for this user. The password must be at least eight characters in length.
 - Confirm Password: Retype the password above.
 3. In the **Subscription Details** section, select a subscription package that you want to assign to this user. See [Creating a Subscription Package](#) on page 136, for more information.
5. Click **OK**.

Managing Clients

Working with Users and Roles

You have completed creating a local user.

Select **Enable** to enable this user profile or select **Disable**.

You can view the list of local users by applying filters. Click the  icon to do so.

The following information is displayed when you click on the user:

- **Summary:** Displays a summary of information about the user.
- **Admin Activities:** Displays information about the administrator activities.
- **Event:** Displays information about events associated with the user. Click the  icon to apply filters.

Click the  icon to export all the data into a CSV file.

NOTE

You can also edit, clone and delete user by selecting the options **Configure**, **Clone** and **Delete** respectively, from the **Local Users** tab.

Creating a Subscription Package

A subscription package defines the characteristics of a subscription that has been created for a registered user. These characteristics include the expiration date of the subscription.

If the user is connected at the time when his or her subscription expires, the user will get disconnected from the AP and any attempts to re-authenticate will fail.

1. Go to **Clients > Users & Roles**.
2. Select the **Subscription Package** tab, and then select the zone for which you want to create the package.

3. Click **Create**.
The **Create Subscription Package** page appears.

FIGURE 42 Create Subscription Package

Create Subscription Package

* Name:

Description:

* Expiration Interval:

* Expiration Value:

OK **Cancel**

4. Configure the options in the **Create Subscription Package** form.
 - Name: Type a name for the subscription package that you are creating.
 - Description: Type a description for this package.
 - Expiration Interval: Set the time unit to use for the package expiration. Options include: Hour, Day, Week, Month, Year and Never.
 - Expiration Value: Set the actual value to use in combination with the Expiration Time.
5. Click **OK**.

You have completed creating a subscription package.

NOTE

You can also edit and delete a package by selecting the options **Configure** and **Delete** respectively, from the **Subscription Package** tab.

Working with Guest Passes

Similar to user accounts, guest passes in the controller allow users to gain access to the controller hotspots. However, unlike user accounts, guest pass users are not required to provide personal information to access the controller hotspots and can therefore remain anonymous.

Guest passes are generated for specific WLANs only – guest pass users will only be able to gain access to the WLANs for which the guest pass was generated.

Generating Guest Passes

Generating guest passes involves four steps:

[Step 1: Create a Guest Access Service](#) on page 138

[Step 2: Create a Guest Access WLAN](#) on page 138

[Step 3: Generate a Guest Pass](#) on page 139

[Step 4: Send Guest Passes to Guest Users](#) on page 141

Step 1: Create a Guest Access Service

1. Follow the instructions in [Creating a Guest Access Portal](#) on page 161 to create at least one guest access service in Guest Access Portal.
2. When you finish creating a guest access service, continue to the next task.

Step 2: Create a Guest Access WLAN

Guest passes are generated for specific WLANs only. Guest pass users will only be able to gain access to the WLANs for which the guest pass is generated.

Follow these steps to create a WLAN that will be used for guest access only.

1. Click **Wireless LANs**.
The **Wireless LANs** page appears.
2. Click **Create**.
The **Create WLAN Configuration** page appears.
3. In **General Options**, configure the following:
 - **Name**
 - **SSID**
 - **Description**
 - **Zone**
 - **WLAN Group**
4. In **WLAN Usage**, configure the following:
 - a) In **Access Network**, select the **Tunnel WLAN traffic through Ruckus GRE** check box if you want to tunnel the traffic from this WLAN back to the controller.
 - b) In **Authentication Type**, click **Guest Access**.
5. Configure the rest of the WLAN settings.
For details on each setting, see the [Working with WLANs](#) section.

- When you finish creating a guest access WLAN, continue to the next step.

FIGURE 43 Creating a WLAN for guest access only

The screenshot shows a configuration panel for a WLAN. It is divided into two main sections: 'Encryption Options' and 'Guest Access Portal'.
Under 'Encryption Options', there is a 'Method' section with radio buttons for WPA2, WPA-Mixed, WEP-64 (40 bits), WEP-128 (104 bits), and None. The 'None' option is selected.
Under 'Guest Access Portal', there are several settings:
- 'Guest Portal Service': A dropdown menu with the text 'Select a guest access' and a '+ Create' button.
- 'Bypass CNA': A checkbox labeled 'Enable' which is checked.
- 'Guest Authentication': A dropdown menu with the text 'Select an authentication se' and a downward arrow.
- 'Guest Accounting': A checkbox labeled 'Use the Controller as Proxy' which is checked, followed by a dropdown menu showing 'KIKK-ACCT' and a '+ Create' button. To the right of this is a field 'Send interim update every' with the value '1' and the unit 'Minutes (0-14+'.

Step 3: Generate a Guest Pass

Follow these steps to generate a guest pass.

- Click **Clients > Guests**.
The **Guest Pass** page appears.
- Click **Generate Guest Pass**.
The **Generate Guest Pass** form appears.
- Configure the following options:
 - Guest Name:** Type a name that you want to assign to the guest user.
 - Guest WLAN:** Select the guest WLAN that you created in [Step 2: Create a Guest Access WLAN](#) on page 138.
 - Number of Passes:** Type the number of guest passes that you want to generate.
 - Pass Valid For:** Set the validity period for the guest pass by filling in the two boxes. For example, if you want the guest pass to be valid for seven days, type **7** in the first box, and then select **Days** in the second box.

Managing Clients

Working with Guest Passes

4. Configure the advanced options:

- a) **Pass Generation:** Select the **Auto Generate** check box if you want the controller to generate the guest pass key automatically.

If you want to generate the guest pass manually, clear the **Auto Generate** check box.

If you are generating more than one guest pass, the Auto Generate check box is selected automatically and is not configurable.

- b) **Pass Effective Since:** Set the guest pass validity period by selecting one of the following options:

- **Effective from the creation time:** This type of guest pass is valid from the time it is first created to the specified expiration time, even if it is not being used by any end user.
- **Effective from first use:** This type of guest pass is valid from the time the user uses it to authenticate with the controller until the specified expiration time. An additional parameter (Guest Pass will expire in X days) can be configured to specify when an unused guest pass will expire regardless of use. The default is 7 days.
- **Expire guest pass if not used within [] days:** If you want this guest pass to expire if it is unused after you generated it, type the number of days in the box (maximum value is 365 days).

- c) **Max Devices Allowed:** Set the number of users that can share this guest pass.

- **Limited to []:** If you want a limited number of users to share this guest pass, click this option, and then type the number in the box.
- **Unlimited:** If you want an unlimited number of users to share this guest pass, click this option.
- **Session Duration:** If you clicked **Unlimited**, this option appears. If you want require users to log on again after their sessions expire, select the **Require guest re-login after []** check box, and then select a time increment. If this feature is disabled, connected users will not be required to re-log in until the guest pass expires.

- d) In **Remarks** (optional), type your notes about this guest pass, if any.

5. Click **Generate**.

The page refreshes, and then the guest pass you generated appears in a table, along with other guest passes that exist on the controller.

Click **Enable** to enable the guest pass for a user, and **Disable** to revoke the guest pass for a particular user.

You have completed generating a guest pass. You are now ready to send the guest pass to guest users. See [Step 4: Send Guest Passes to Guest Users](#) on page 141 for information.

You can view the list of guest passes by applying filters. Click the  icon to do so.

The following information is displayed when you click on the guest pass created:

- **Summary:** Displays a summary of information about the user and credentials.
- **Admin Activities:** Displays information about the administrator activities.
- **Event:** Displays information about events associated with the user.

Click the  icon to apply filters. Click the  icon to export all the data into a CSV file.

FIGURE 44 Generating a guest pass

Generate Guest Pass ✕

* Guest Name:

* Guest WLAN:

* Number of Passes:

* Pass Valid For:

Advanced Options ▼

Pass Generation: Auto Generate

* Pass Value:

Pass Effective Since: Effective from the creation time
 Effective from first use

* Expire new guest pass if not used within: days

* Max Devices Allowed: Limited to
 Unlimited

Remarks:

Step 4: Send Guest Passes to Guest Users

Deliver the guest passes to guest users as per the delivery options that you choose.

The page that appears after you generate a guest pass contains options for delivering the guest pass to guest users (see the following image).

FIGURE 45 Options for delivering guest passes to guest users

Here are the generated guest passes

Guest Name	Manage By	Key	Remarks	Generated	Expiration Date	WLAN
Sam	System	WV3QSH6q	One day pass	2017/03/08 17:41:30	2017/03/09 17:41:30	[SZ-300-GUEST] of [TEST-JL...
Sen	System	sajeXkCg	N/A	2017/03/08 18:45:26	N/A	[SZ-300-GUEST] of [TEST-JL...
test2	System	DNp2u8D3	N/A	2017/01/18 14:19:18	2017/01/19 14:19:18	[SZ-300-GUEST] of [TEST-JL...

3 total records - 1 -

Creating a Guest Pass Template

A guest pass template is a HTML file which contains variables for the information that guest users need to connect to the controller hotspots (for example, guest name, key, and WLAN name), and actual instructions for connecting to the guest WLAN.

A default printout template exists in the controller. If you want to create your own printout template, follow these steps.

1. Go to **Clients > Guests**.
2. Click **Guest Pass Template**.

The **Guest Pass Template** page appears.

3. In the **Guest Instruction HTML Template** section, click `default.html`, which is the default guest pass printout template.

The content of the default guest pass printout template appears in the *Name: default.html*.

4. Click **Download** below the template preview area to download a copy of the template to your computer.
5. Using an HTML editor, create a new HTML file.
6. Add content to the file.

Typically, a printout template contains instructions for connecting to the controller hotspot. See the following image for the content of the default printout template.

FIGURE 46 Content of the default printout template

Connecting as a Guest to the Corporate Wireless Network

Greetings, **{GP_GUEST_NAME}**

You have been granted access to the company wireless network, which you can use to access both the World Wide Web and Internet, and to check your personal email.

Your guest pass key is: **{GP_GUEST_KEY}**

This guest pass is valid until **{GP_VALID_TIME}**

Connect your wireless-ready PC to the following network(s): **{GP_GUEST_WLAN}**, as detailed in the instructions printed below.

Before you start, please review the following requirements.

7. Insert the following variables into the content of your template:
 - *{GP_GUEST_NAME}*: This is the guest pass user name.
 - *{GP_GUEST_KEY}*: This is the guest pass key.
 - *{GP_VALID_TIME}*: This is the expiration date and time of the guest pass.
 - *{GP_GUEST_WLAN}*: This is the WLAN with which the guest user can associate using the guest name and guest key.
8. Save the file.
9. In the **Guest Instruction HTML Template** page, click the **Upload** button for the template that you are creating.
The **Upload a Template File** form appears on the right side of the page.
10. Configure the **Upload a Template File** options:
 - **Template Name**: Type a name for the template that you are uploading.
 - **Template File**: Click **Browse**, and select the template file you created.
11. Click **Upload**.
An information message box appears and informs you that the template file has been uploaded successfully.
12. Click **OK**.
The template file you uploaded now appears in the list of templates.

FIGURE 47 The **Upload a Template File** form

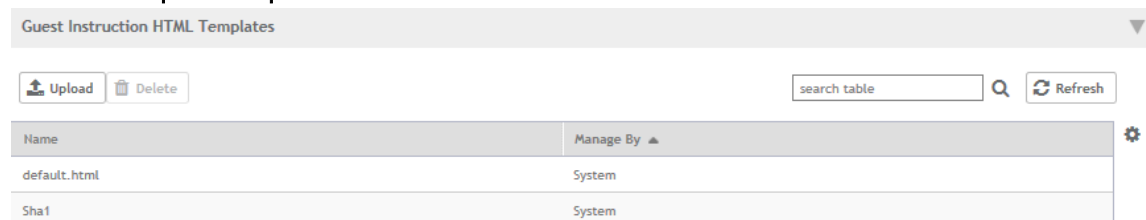

Creating a Guest Instruction SMS Template

A guest SMS template is a text file which contains variables for the information that guest users need to connect to the controller hotspots (for example, guest name, key, and WLAN name), and actual instructions for connecting to the guest WLAN.

A default printout template exists in the controller. If you want to create your own printout template, follow these steps.

1. Go to **Clients > Guests**.
2. Click **Guest Pass Template**.
The **Guest Pass Template** page appears.
3. In the **Guest Instruction SMS Template** section, click `default.txt`, which is the default guest pass printout template.
The content of the default guest pass printout template appears in the *Name: default.txt*.
4. Click **Download** below the template preview area to download a copy of the template to your computer.
5. Using an HTML editor, create a new text file.

Managing Clients

Working with Guest Passes

6. Add content to the file.

Typically, a printout template contains instructions for connecting to the controller hotspot. See the following image for the content of the default printout template.

FIGURE 48 Content of the default printout template

Connecting as a Guest to the Corporate Wireless Network

Greetings, **{GP_GUEST_NAME}**

You have been granted access to the company wireless network, which you can use to access both the World Wide Web and Internet, and to check your personal email.

Your guest pass key is: **{GP_GUEST_KEY}**

This guest pass is valid until **{GP_VALID_TIME}**

Connect your wireless-ready PC to the following network(s): **{GP_GUEST_WLAN}**, as detailed in the instructions printed below.

Before you start, please review the following requirements.

7. Insert the following variables into the content of your template:

- *{GP_GUEST_NAME}*: This is the guest pass user name.
- *{GP_GUEST_KEY}*: This is the guest pass key.
- *{GP_VALID_TIME}*: This is the expiration date and time of the guest pass.
- *{GP_GUEST_WLAN}*: This is the WLAN with which the guest user can associate using the guest name and guest key.

8. Save the file.

9. In the **Guest Instruction SMS Template** page, click the **Upload** button for the template that you are creating.

The **Upload a Template File** form appears on the right side of the page.

10. Configure the **Upload a Template File** options:

- **Template Name**: Type a name for the template that you are uploading.
- **Template File**: Click **Browse**, and select the template file you created.

11. Click **Upload**.

An information message box appears and informs you that the template file has been uploaded successfully.

12. Click **OK**.

The template file you uploaded now appears in the list of templates.

FIGURE 49 The **Upload a Template File** form

Guest Instruction SMS Templates

Upload Delete search table Refresh

Name ▲	Manage By
default.txt	System

Exporting the Guest Pass to CSV

Follow these steps to export the last generated guest passes to a comma-separated value (CSV) file.

1. From the generate guest pass list, select the guest passes that you want to export to CSV.
2. Click **Export Selected**.

Your web browser downloads the CSV file to its default download location.

3. Go to your web browser's default download location and look for a file named `guestpass.csv`.
4. Using Microsoft Excel or a similar application, open the CSV file. The CSV file displays the details of the guest passes, including:
 - Guest Name
 - Key
 - Remarks
 - Generated
 - Expiration Date
 - WLAN

You have completed exporting the last generated guest passes to CSV.

FIGURE 50 A sample CSV of generated guest passes when opened in Excel

Guest Name	Key	Remarks	Generated	Expiration Date	WLAN
test2	DNp2u8D3		18-01-2017 14:19	19-01-2017 14:19	[SZ-300-GUEST] of [TEST-JILANI]

Generating Guest Passes from an Imported CSV

You can also manually define the guest passes that you want to generate in a comma-separated value (CSV) file (a sample of which is available for download from the **Guest Pass** page).

Follow these steps to generate guest passes from an imported CSV file.

1. Click **Clients > Guests**.

The **Guest Pass** page appears.

Managing Clients

Working with Guest Passes

2. Click **Import Guest Pass**,

The **Import Guest Pass** form appears.

3. Look for the following text under Browse:

To download a sample guest pass, click here.

4. Click the **here** link to download the sample CSV file.
5. Using Microsoft Excel or a similar application, open the CSV file.
6. In the CSV file, fill out the following columns:
 - **#Guest Name (Must)**: Assign a user name to the guest pass user.
 - **Remarks (Optional)**: Add some notes or comments about this guest pass.
 - **Key**: Enter a guest pass key or leave it blank so the controller can generate the key automatically.

FIGURE 51 The sample CSV file when opened in Excel

	A	B	C
1	#Guest Name (Must)	Remarks	Key (Empty implies random key)
2	Batch-Guest-1	Batch generation	AAAAAAAA
3	Batch-Guest-2	Batch generation	
4	Batch-Guest-3		
5			
6			
7			
8			
9			
10			
11			
12			
13			
14			

7. Save the CSV file.
8. Go back to the **Import Guest Pass** page, and then configure the following settings on the Common Guest Pass Settings:
 - **Guest WLAN**: Select the guest WLAN that you created in [Step 2: Create a Guest Access WLAN](#) on page 138.
 - **Pass Valid For**: Set the validity period for the guest pass by filling in the two boxes. For example, if you want the guest pass to be valid for seven days, type **7** in the first box, and then select **Days** in the second box.

9. Configure the advanced options:
 - a) **Pass Effective Since:** Set the guest pass validity period by selecting one of the following options:
 - **Effective from the creation time:** This type of guest pass is valid from the time it is first created to the specified expiration time, even if it is not being used by any end user.
 - **Effective from first use:** This type of guest pass is valid from the time the user uses it to authenticate with the controller until the specified expiration time. An additional parameter (**Guest Pass will expire in X days**) can be configured to specify when an unused guest pass will expire regardless of use. The default is 7 days.
 - **Expire guest pass if not used within [] days:** If you want this guest pass to expire if it is unused after you generated it, type the number of days in the box (maximum value is 365 days).
 - b) **Max Devices Allowed:** Set the number of users that can share this guest pass.
 - **Limited to []:** If you want a limited number of users to share this guest pass, click this option, and then type the number in the box.
 - **Unlimited:** If you want an unlimited number of users to share this guest pass, click this option.
 - **Session Duration:** If you clicked **Unlimited**, this option appears. If you want require users to log on again after their sessions expire, select the **Require guest re-login after []** check box, and then select a time increment. If this feature is disabled, connected users will not be required to re-login until the guest pass expires.
10. In **Guest List CSV File** (at the top of the page), click **Browse**, and then select the CSV file you edited earlier.
The page refreshes, and the number of guest passes that the controller has identified in the CSV file appears below the **Browse** button.
11. Click **Import**.
The page refreshes, and then the guest pass you generated appears in a table, along with other guest passes that exist on the controller.

You have completed generating a guest pass. You are now ready to send the guest pass to guest users. See [Step 4: Send Guest Passes to Guest Users](#) on page 141 for information.

FIGURE 52 The Guest Pass page for importing a CSV file

Here are the generated guest passes

Print Selected Export Selected Email SMS Delete Enable Disable More Filter Off search table

Guest Name	Manage By	Key	Remarks	Generated	Expiration Date	WLAN
Sam	System	Ww3QSH6q	One day pass	2017/03/08 17:41:30	2017/03/09 17:41:30	[SZ-300-GUEST] of [TEST-JL...
Sen	System	sajeXkCg	N/A	2017/03/08 18:45:26	N/A	[SZ-300-GUEST] of [TEST-JL...
test2	System	DNp2u8D3	N/A	2017/01/18 14:19:18	2017/01/19 14:19:18	[SZ-300-GUEST] of [TEST-JL...

3 total records - 1 -

Sending the Guest Pass via Email

To send guest passes via email, you must have added an external email server to the controller.

Follow these steps to send the guest pass via email.

1. From the generated guest passes list, select the guest passes that you want to send via email.
2. Click **Email**.

The Recipient Email form appears on the right side of the page (see [Figure 53](#)).

Managing Clients

Working with Guest Passes

3. Click **Add New**.
4. In the box that appears below, type the email address to which you want to send the guest passes.
5. To add another recipient, click **Add New** again, and then type another email address.
6. When you have finished adding all the email recipients, click **Send Email**.

A dialog box appears and informs you that the emails have been sent to the message queue successfully

7. Click **OK** to close the dialog box.

You have completed sending guest passes via email.

FIGURE 53 Use the Recipient Email form to specify who will receive the guest passes via email

The screenshot shows a web interface for managing guest passes. At the top, there is a header "Here are the generated guest passes" with a dropdown arrow. Below this is a toolbar with buttons for "Print Selected", "Export Selected", "Email", "SMS", "Delete", "Enable", "Disable", and "More". A table lists three guest passes:

Guest Name	Manage By	Key	Remarks	Generated	Expiration Date	WLAN
Sam	System	Wv3Q5H6q	One day...	2017/03/08 17:41:30	2017/03/09 17:41:30	[SZ-300-GUES
Sen	System	sajeXkCg	N/A	2017/03/08 18:45:26	N/A	[SZ-300-GUES
test2	System	DNp2u8D3	N/A	2017/01/18 14:19:18	2017/01/19 14:19:18	[SZ-300-GUES

Below the table is a "Recipient Email" form with a gear icon, a text input field containing "sama@yahoo.co", and buttons for "Add New" and "Remove". A "Send Email" button is also visible. At the bottom right, it says "3 total records" with navigation arrows.

Printing the Guest Pass

After you generate the guest pass, you can print the guest pass information, which contains the guest user information and instructions on how to connect to the hotspot, and give it to the guest user.

NOTE

If your browser is blocking pop-ups, make you temporarily disable the pop-up blocker so you can view and print the guest pass.

Follow these steps to print a guest pass.

1. From the generated guest passes list, select the guest passes that you want to print.
2. In **Guest Instruction HTML Template**, select a printout template to use.

The default printout template (`default.html`) is selected by default. If you created custom printout templates (see [Creating a Guest Pass Template](#) on page 142), they will appear in the drop-down menu.

3. Click **Print Selected**.

A new browser page appears, which displays the guest pass and available printing options.

4. Configure your printer settings, and then print the guest passes.

You have completed printing the guest passes.

FIGURE 54 What a guest pass printout looks like

Connecting as a Guest to the Corporate Wireless Network

Greetings, **guest_o7fti** ← **Guest Name**
You have been granted access to the company wireless network, which you can use to access both the World Wide Web and Internet, an
Your guest pass key is: **vTK1SERh** ← **Key**
This guest pass is valid until **13/06/13 13:13** ← **Valid For**
Connect your wireless-ready PC to the following network(s): **SSID Naomi** ← **Guest Network SSID**
Before you start, please review the following requirements.

Sending the Guest Pass via SMS

To send guest passes via sms, you must have added an external SMS gateway to the controller.

Follow these steps to send the guest pass via email.

1. From the generated guest passes list, select the guest pass that you want to send via SMS.
2. Click **SMS**.

SMS options appear on the right side of the page (see [Figure 55](#)).

3. In Guest Instruction SMS Template, select the SMS template that you want to use.
4. Click **Add New**.
5. In the box that appears below, type the phone number to which you want to send the guest passes via SMS.
6. To add another SMS recipient, click **Add New** again, and then type another phone number.
7. When you have finished adding all the SMS recipients, click **Send SMS**.

A dialog box appears and informs you that the SMS messages have been sent to the message queue successfully

8. Click **OK** to close the dialog box.

You have completed sending guest passes via SMS.

Managing Clients

Working with Dynamic PSKs

FIGURE 55 Options for sending guest passes via SMS

Here are the generated guest passes

Print Selected Export Selected Email SMS Delete Enable Disable

Guest Name	Manage By	Key	Remarks	Generated	Expiration
Sam	System	Wv3Q5H6q	One day...	2017/03/08 17:41:30	2017/03/08 17:41:30
Sen	System	sajeXkCg	N/A	2017/03/08 18:45:26	N/A
test2	System	DHp2u8D3	N/A	2017/01/18 14:19:18	2017/01/18 14:19:18

3 total records < 1 >

Guest Instruction SMS Template: default.txt

Recipient Phone Number: 9876543210 x Remove

Send SMS

Working with Dynamic PSKs

Dynamic PSKs (DPSKs) are unique pre-shared keys assigned to a user or device. DPSKs are used to provide secure wireless access, which helps avoid manual wireless configuration and managing encryption keys.

DPSK is a form of PSK (static key) in a WPA2 WLAN and its purpose is to provide each user device with a unique dynamic PSK to associate to a WLAN without any modifications to the WLAN configuration. For example, a school administrator provides a time-limited DPSK for student's device so that the student can access the school's WLAN for the period their DPSK is valid. After the validity period ends, the DPSK expires and the student's device can no longer access the school's WLAN. Without the use of DPSKs, the school administrator would have to change the default static key to prevent the student from using the WLAN resources, which in turn would impact all other users of that WLAN.

Individual DPSKs can be deleted in the event of a student leaving the school, or their device being lost or stolen without impacting other users of the WLAN.

A "bound" DPSK is one which is assigned to the MAC address of a user device at the time of creation. No other user device can utilize this DPSK. Bound DPSKs are stored in on APs.

An "unbound" DPSK is not assigned to a device's MAC address during creation, but upon its first use (that is, when the device first connects to a WLAN and the DPSK is entered as the WLAN security key). Once a DPSK becomes assigned to a user device, it becomes bound and no other user device can use it.

NOTE

If you generate a single unbound DPSK, then only one device can be connected to the DPSK WLAN by the key, since other devices can still use "admin" PSK to connect to the DPSK WLAN. However, when devices from different APs try to use the same unbound DPSK simultaneously, for a short period, they could both connect to the WLAN successfully, but the later device will be disconnected by the controller. If the AP happens to disconnect from the controller, the device could stay connected until the AP connects back to the controller.

When DPSKs are created, there are some prevented behaviors that are considered database conflicts such as the following:

- You cannot create two unbound DPSKs with the same passphrase.
- You cannot create two bound DPSKs for the same MAC address and passphrase. Create two DPSKs for the same MAC address, the former will be replaced. However, you can create multiple bound DPSKs with different MAC addresses and the same passphrase.
- You can also create bound DPSKs and a single unbound DPSK with the same passphrase.

UEs within a PSK WLAN use the same shared key to encrypt data traffic, but if the key is compromised by even one WLAN user, the entire user traffic can be accessed/hacked. Therefore, a secure tunnel is created for each user connected to the WLAN, by configuring the PSK WLAN as an *Internal* or *External* DPSK.

In Internal DPSKs, the controller manages and records the DPSK for each individual user and a limited number of DPSKs are supported.

In External DPSKs, the DPSK is maintained by the Radius Server (AAA) and Radius protocols are used to authenticate the UE. The UE is authenticated by the open authentication WLAN - WPA/WPA2 encryption where in, the controller uses the RADIUS interface with the RADIUS server (AAA includes the DPSK in the Radius response or Access Accept message and sends it to the AP) so that the DPSK is maintained in one place. There is no limitation on the number of DPSK supported in this mode.

NOTE

Only proxy AAA authentication is supported for External DPSK.

NOTE

External DPSKs are supported only on bounded DPSKs.

Viewing Dynamic PSKs

View dynamic PSKs that have been generated on the controller.

The following information about dynamic PSKs is available:

- User Name
- MAC Address
- WLAN (SSID)
- VLAN ID
- Created Date
- Expiration Date
- Expired
- Actions

Follow these steps to view the DPSKs:

1. Click **Clients > Dynamic PSK > other options**.

The **Dynamic PSK** page appears listing the DPSKs that have been generated.

You can sort the list of DPSKs or export the DPSKs listed to a CSV file.

2. An optional step is to select the **Delete Expired DPSKs** option available on the **Dynamic PSKs** page allows you to customize when the system must remove the DPSKs that are no longer valid.

Following are the settings available:

- **Never:** No action must be taken for the expired DPSKs.
- **After 1 day:** Auto deletes DPSKs that have expired after one day.
- **After 6 months:** Auto deletes DPSKs that have expired after 6 months.

You have completed viewing the list of dynamic PSKs.

Generating Dynamic PSKs

You can generate new dynamic PSKs to secure the WiFi network.

Follow these steps to generate the dynamic PSKs (DPSKs):

1. Click **Clients > Dynamic PSK > other options**.

The **Dynamic PSK** page appears listing the PSKs that were generated.

Managing Clients

Working with Dynamic PSKs

2. Click **Generate DPSKs**.

The **Generate DPSKs** dialog box appears.

3. Provide the following information

- **WLAN:** From the drop-down list, select a DPSK-enabled WLAN.
- **Number of DPSKs:** Type the number of PSKs you want to create. You can generate up to a maximum of 320 DPSKs at a time.

NOTE

For SZ300/SCG200/vSZ-H, a maximum of 10,000 DPSKs can be included within an AP zone and a maximum of 20,000 DPSKs can be included within a cluster (Carrier: per Domain. Enterprise: System), and up to 50,000 DPSKs can be included within a cluster (Carrier: System). Up to 320 unbound + group DPSKs, and 64 group DPSKs (those that are not bound to a MAC address) can be included within an AP zone.

- **User Name:** Leave it blank if you want the controller to auto-generate the user name, or enter the user name manually.
- **Passphrase:** Leave it blank if you want the controller to auto-generate the passphrase, or enter the passphrase manually.
- **User Role:** If you have created user roles, select the user role that you want to assign to the device that connects to the SmartZone network using this DPSK. The device will be assigned the same attributes and permissions (VLAN, UTP, time restrictions, etc.) that have been defined for the assigned user role.
- **VLAN ID:** Type a VLAN ID within the range 1-4094.
- **Group DPSK:** If you want multiple devices to be able to use this DPSK, click **Yes**. If you want only a single device to use this DPSK (bound DPSK), click **No**.

4. Click **Generate**.

You have completed creating dynamic PSKs.

To delete a DPSK, click the DPSK from the list, and then click the  **Delete** icon.

Importing Dynamic PSKs

You can import CSV files to create DPSKs to secure the WiFi network.

Follow these steps to import dynamic PSKs (DPSKs):

1. Click **Clients > Dynamic PSK**.

The **Dynamic PSK** page appears and lists the DPSKs that have been generated.

- Click the **Download Sample (CSV)** link to download the CSV template for generating DPSKs.
A sample CSV file is displayed as show in the figure.

FIGURE 56 Sample CSV file

A	B	C	D	E	F
User Name	MAC Address	VLAN ID	User Role	Passphrase	Group DPSK
DPSK-User-1	00:11:22:33:44:44				
DPSK-User-2	00:11:22:33:44:55	1		passphrase02	
DPSK-User-3	11:22:33:44:55:66	2	testUserRole	passphrase03	
Group-DPSK-1					Y

- Modify the CSV file as appropriate and save it. The following are the fields that need to be completed in the CSV file:
 - User Name** (mandatory field): Enter the user name.
 - MAC Address** (optional): Enter the MAC address of the device for which to generate a DPSK (bound DPSK). If you leave the MAC address field empty, the controller will generate an unbound DPSK.
 - VLAN ID** (optional): Enter a value to override the WLAN VLAN ID, or leave it empty if you do not want to override the WLAN VLAN ID.
 - User Role** (optional): If you have created user roles, type the name of the user role that you want to assign to the device that connects to the SmartZone network using this DPSK. The device will be assigned the same attributes and permissions (VLAN, UTP, time restrictions, etc.) that have been defined for the assigned user role.
 - Passphrase** (optional): Leave it blank if you want the controller to auto-generate the passphrase, or enter the passphrase manually.
 - Group DPSK** (optional): Enter **Y** to indicate the entry is a Group DPSK if you want multiple devices to use this DPSK.

- Click **Import CSV**.

The **Import CSV** dialog box appears.

NOTE

Importing a CSV file that contains a MAC address to which an existing DPSK (on the same target WLAN) is already assigned will replace the existing DPSK on the controller database.

- In **DPSK Enabled WLAN**, select a WLAN from the drop-down list. Only WLANs that support DPSK must be selected.
- In **Choose File**, click **Browse** to choose the CSV file.
Click **Clear** if you want to replace the CSV file.
You can also specify **Group DPSK** in the CSV file.
- Click **Upload**.

The generated DPSKs appear in the table on the **Dynamic PSK** page.

NOTE

You can import up to 1,000 DPSKs (not over 320 unbound + group DPSKs) at a time.

Managing Clients

Working with Dynamic PSKs

- Click **Download CSV** to download a CSV that contains the generated DPSKs.

The CSV file appears in the following format.

FIGURE 57 New CSV format

User Name	MAC	WLAN (SSID)	Passphrase	VLAN ID	Created Date	Expiration Date
DPSK-User-1	00:11:22:33:44:44	joe-wlan (joe-wlan)	4#4BSXMe		3/17/2016 18:55	Unlimited
DPSK-User-2	00:11:22:33:44:55	joe-wlan (joe-wlan)	rE<r0[]y	1	3/17/2016 18:55	Unlimited
DPSK-User-3	11:22:33:44:55:66	joe-wlan (joe-wlan)	'q=7vqfE	2	3/17/2016 18:55	Unlimited

You have completed generating DPSKs.

NOTE

Click **Export All** to export all the dynamic PSKs to a CSV file. You can also export specific dynamic PSKs by selected them and clicking **Export Selected**.

Creating an External DPSK Over RADIUS WLAN

External DPSKs use the radius interface with the RADIUS Server (AAA) to maintain the DPSKs centrally. There is no limitation in the number of DPSKs that are supported.

To create an external DPSK over RADIUS WLAN:

- Create an Authentication Service. Refer, [Creating Non-Proxy Authentication AAA servers](#).
- Create an Accounting Service. Refer, [Creating Proxy Accounting AAA Servers](#).
- Create Zone Configuration. Refer, [Creating an AP Zone](#).

4. Create a WLAN Configuration for DPSK. Refer, [Creating a WLAN Configuration](#).

FIGURE 58 External DPSK Configuration

The screenshot shows the 'Create WLAN Configuration' dialog box with the following settings:

- WLAN Usage:**
 - Access Network: Tunnel WLAN traffic through Ruckus GRE
 - Authentication Type: Standard usage (For most regular wireless networks), Hotspot (WISPr), Guest Access, Web Authentication, Hotspot 2.0 Access, Hotspot 2.0 Secure Onboarding (OSEN), WeChat
- Authentication Options:**
 - Method: Open, 802.1x EAP, MAC Address
- Encryption Options:**
 - Method: WPA2, WPA-Mixed, WEP-64 (40 bits), WEP-128 (104 bits), None
 - Algorithm: AES, AUTO
 - 802.11w MFP: Disabled, Capable, Required
 - Dynamic PSK: Disable, Internal, External
- Authentication & Accounting Service:**
 - Authentication Service: Use the controller as proxy, Select an authentication servi..., + Create
 - Accounting Service: Use the controller as proxy, Disable, + Create

Buttons: OK, Cancel

Application Recognition and Control

- [Monitoring Applications](#)..... 157

Application Recognition and Control enables you to identify, monitor and control the applications that are running on wireless clients associated with managed APs.

Monitoring Applications

If you have enabled Application Recognition and Control for at least one WLAN, you can monitor the applications that run on wireless clients associated with that WLAN.

NOTE

To configure application recognition and control policies, go to **Services and Profiles > Application Control**. For more information, see [Configuring Application Controls](#) on page 189.

To monitor the top applications by traffic consumption on the wireless network:

1. Go to **Applications** on the main menu.
2. Select whether to view the **Top Applications** by **Application** or **Port**, select a time period to display, and optionally filter the data by AP MAC address and WLAN name using the drop-down menus.

Application Recognition and Control

Monitoring Applications

- Select whether to display the Top 10 or Top 25 applications in **Chart** or **Table** format.

NOTE

If Application Recognition and Control is unable to find an application name, it displays the source and destination IP: port address of the application

FIGURE 59 Top Applications - Chart View

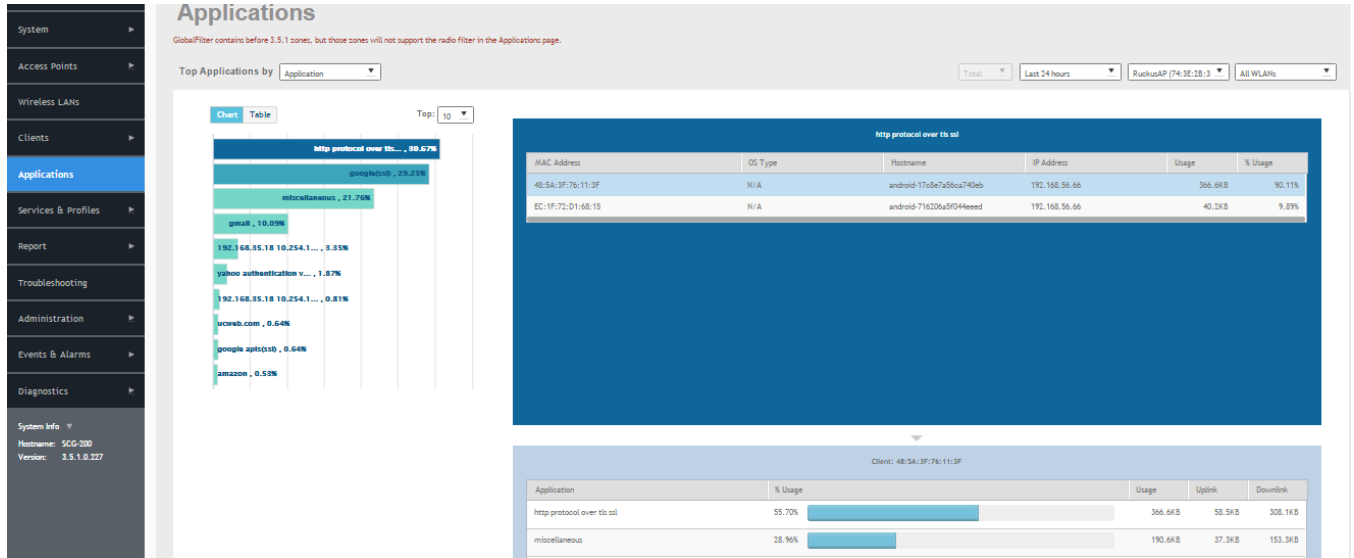
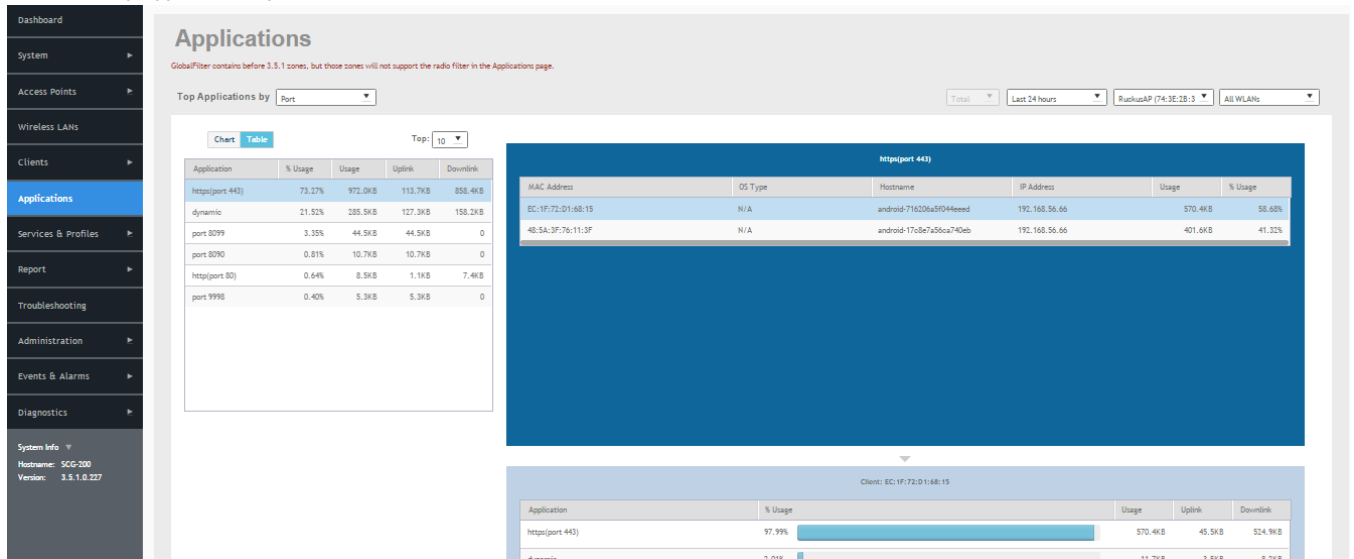
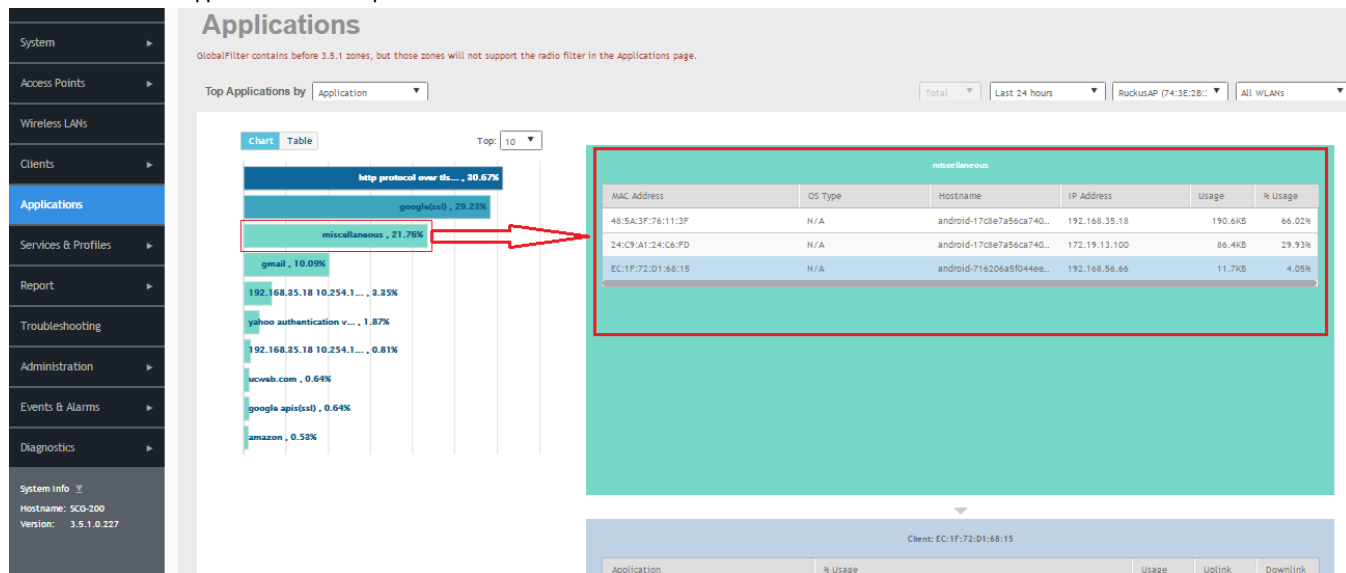

FIGURE 60 Top Applications by Port - Table View



- Click on an application from the list on the left (either Chart or Table view) to view a list of the top clients using the selected application in the list on the right. The client list displays the client's MAC address, OS, hostname, IP address (IPv4 and IPv6), and application usage volume and percent of application traffic generated by the client. From the Total option, you can also filter the data based on the radio frequencies (2.4 GHz and 5 GHz).

FIGURE 61 Click an application to view top client details



- Click on a client in the list on the right, and scroll down to the client specific details table on the bottom right to view the top 10 applications used by the client.

FIGURE 62 Click a client to view application details

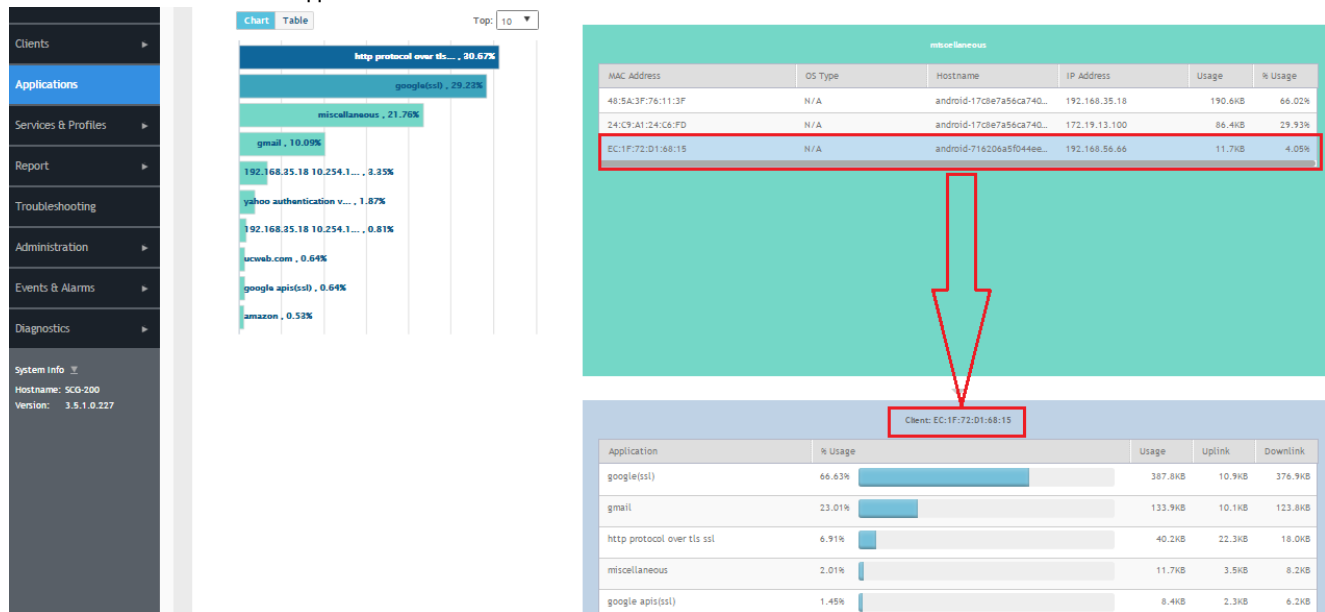

NOTE

You can configure application control policies (denial, rate limiting, and QoS) using the **Services and Profiles > Application Control** page. For more information, see [Configuring Application Controls](#) on page 189.

Services and Profiles

• Working with Hotspots and Portals.....	161
• Configuring Access Control.....	177
• Configuring Application Controls.....	189
• URL Filtering.....	197
• Authentication.....	203
• Accounting.....	215
• Classifying Rogue Policy.....	218
• Bonjour.....	219
• Working with Tunnels and Ports.....	225
• Managing Core Network Tunnels.....	239
• Location Services.....	244
• DHCP/NAT.....	245

The Services and Profiles menu provides options for monitoring and configuring services such as guest access, access controls, authentication servers, application recognition and control, Bonjour services, tunneling, location services and DHCP server configuration.

Working with Hotspots and Portals

Creating a Guest Access Portal

Using the controller's Guest Access features, you can provide visitors to your organization limited access to a guest WLAN with configurable guest policies. The following sections describe how to configure guest WLANs and access policies that control guest use of your network.

Each guest WLAN must be associated with a Guest Access service portal, which defines the behavior of the guest WLAN interface. Follow these steps to create a guest access service.

1. Go to **Services & Profiles > Hotspots & Portals**.
2. Select the **Guest Access** tab, and then select the zone for which you want to create the portal.

Services and Profiles

Working with Hotspots and Portals

3. Click **Create**.

The **Create Guest Access Portal** page appears.

FIGURE 63 Creating a Guest Access Portal

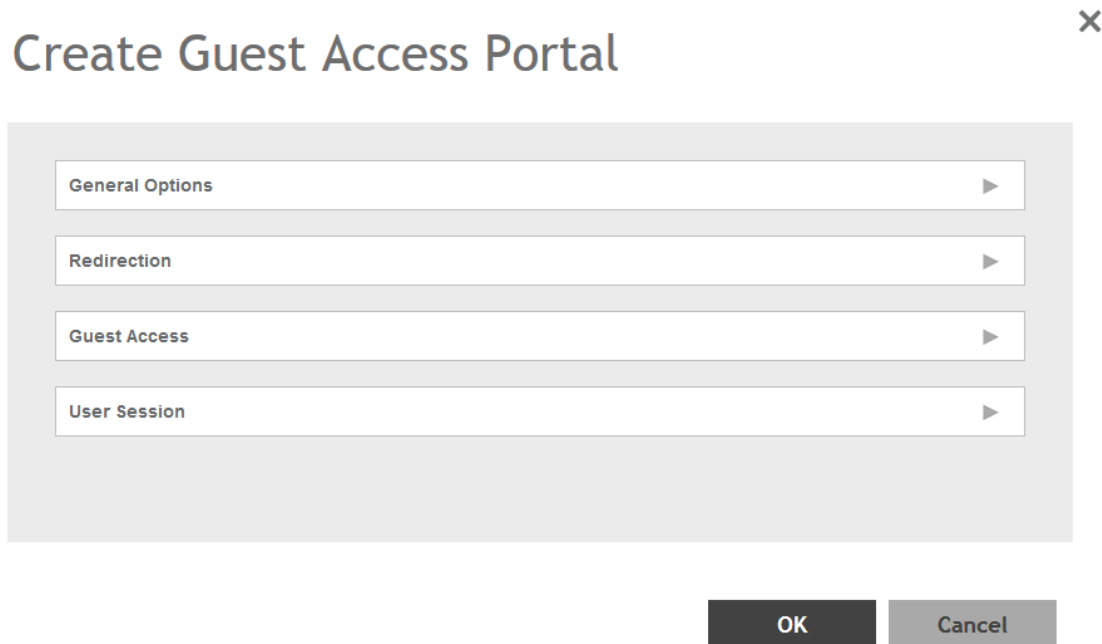

Create Guest Access Portal ×

General Options ▶

Redirection ▶

Guest Access ▶

User Session ▶

OK Cancel

4. Configure the following:
 1. General Options
 - Portal Name: Type a name for the guest access service portal that you are creating.
 - Portal Description: Type a short description of the guest access service portal.
 - Language: Select the display language to use for the buttons on the guest access logon page.
 2. Redirection: select where to redirect the user after successfully completing authentication.
 - Redirect to the URL that the user intends to visit: Allows the guest user to continue to their destination without redirection.
 - Redirect to the following URL: Redirect the user to a specified web page (entered into the text box) prior to forwarding them to their destination. When guest users land on this page, they are shown the expiration time for their guest pass.
 3. Guest Access
 - Guest Pass SMS Gateway: You can deliver the guest pass to the user using Short Message Service (SMS). But first you need to configure an SMS server. If you previously configured an SMS server, you can select it here or you can select **Disable**.
 - Terms and Conditions: To require users to read and accept your terms and conditions prior to use, **Show Terms and Conditions** check box. The box below, Terms and Conditions which contains the default Terms of Use text, becomes editable. Edit the text or leave it unchanged to use the default text.
 - Web Portal Logo: By default, the guest hotspot logon page displays the Ruckus Wireless logo. To use your own logo, click the **Browse** button, select your logo Web Portal Logo (recommended size is 138 x 40 pixels, maximum file size is 20KB), and then click **Open**.
 - Web Portal Title: Type your own guest hotspot welcome text or accept the default welcome text (Welcome to the Guest Access login page).
 4. User Session
 - Session Timeout: Specify a time limit after which users will be disconnected and required to log on again.
 - Grace Period: Set the time period during which clients will not need to re-authenticate after getting disconnected from the hotspot. Enter a number (in minutes) between 1 and 14399.
5. Click **OK**.

You have completed creating a guest access service.

NOTE

You can also edit, clone and delete a guest access portal by selecting the options **Configure**, **Clone** and **Delete** respectively, from the **Guest Access** tab.

Working with Hotspot (WISPr) Services

A hotspot is a venue or area that provides Internet access to devices with wireless networking capability such as notebooks and smart phones.

Hotspots are commonly available in public venues such as hotels, airports, coffee shops and shopping malls. Configure a traditional (WISPr 1.0) hotspot service to provide public access to users via its WLANs. In addition to the controller and its managed APs, you will need the following to deploy a hotspot:

Captive Portal: A special web page, typically a login page, to which users that have associated with your hotspot will be redirected for authentication purposes. Users will need to enter a valid user name and password before they are allowed access to the Internet through the hotspot.

Services and Profiles

Working with Hotspots and Portals

RADIUS Server: A Remote Authentication Dial-In User Service (RADIUS) server through which users can authenticate.

For installation and configuration instructions for the captive portal and RADIUS server software, refer to the documentation that was provided with them. After completing the steps below, you will need to edit the WLAN(s) for which you want to enable Hotspot service. The controller supports up to 32 WISPr hotspot service entries, each of which can be assigned to multiple WLANs.

Creating a Hotspot (WISPr) Portal

Define the basic settings that you need to configure to create a hotspot service.

Before creating a hotspot, you need to create a user defined interface.

1. Go to **Services & Profiles > Hotspots & Portals**.
2. Select the **Hotspot (WISPr)** tab, and then select the zone for which you want to create the portal.
3. Click **Create**.

The **Create Hotspot (WISPr) Portal** page appears.

FIGURE 64 Creating a Hotspot (WISPr) Portal

General Options

Redirection

Smart Client Support: None Enable Only Smart Client Allowed

Logon URL: Internal External

* Redirect unauthenticated user to the URL for authentication:

* Redirected MAC Format: AA:BB:CC:DD:EE:FF

Start Page: After user is authenticated,
 Redirect to the URL that user intends to visit. Redirect to the following URL:

*

HTTPS Redirect: If enabled, the AP will try to redirect HTTPS requests to the hotspot portal

User Session

OK Cancel

4. Configure the following:
 1. General Options
 - Portal Name: Type a name for the hotspot service portal that you are creating.
 - Portal Description: Type a short description of the hotspot service portal.
 2. Redirection: select where to redirect the user after successfully completing authentication.
 - Smart Client Support: select one of the following
 - None: Select this option to disable Smart Client support on the hotspot service.
 - Enable: Selection this option to enable Smart Client support.
 - Only Smart Client Allowed: Select this option to allow only Smart Clients to connect to the hotspot service.
 - Logon URL: select one of the following
 - Internal: Type the internal URL of the subscriber portal (the page where hotspot users can log in to access the service).
 - External: Type the external URL of the subscriber portal.
 - Redirect MAC Format: Type the MAC address to which redirection must be done.
 - Start Page: select one of the following
 - Redirect to the URL that the user intends to visit: You could redirect users to the page that they want to visit.
 - Redirect to the following URL: You could set a different page where users will be redirected (for example, your company website).
 - HTTPS Redirect: Enable this option if you want the AP to redirect HTTPS requests to the Hotspot portal.
 3. User Session
 - Session Timeout: Set a time limit (in minutes) after which users will be disconnected from the hotspot service and will be required to log on again.
 - Grace Period: Set the time period (in minutes) during which disconnected users are allowed access to the hotspot service without having to log on again.
 4. Location Information
 - Location ID: Type the ISO and ITU country and area code that the AP includes in accounting and authentication requests. The required code includes:
 - isocc (ISO-country-code): The ISO country code that the AP includes in RADIUS authentication and accounting requests.
 - cc (country-code): The ITU country code that the AP includes in RADIUS authentication and accounting requests.
 - ac (area-code): The ITU area code that the AP includes in RADIUS authentication and accounting requests.
 - network: The following is an example of what the Location ID entry should look like:
isocc=us,cc=1,ac=408,network=RuckusWireless
 - Location Name: Type the name of the location of the hotspot service.
 5. Walled garden: A walled garden is a limited environment to which an unauthenticated user is given access for the purpose of setting up an account.

Click **Add** to add a user to walled garden, to provide access.

Click **Import CSV** to import the CSV file with user information.
5. Click **OK**.

You have completed creating a Hotspot (WISPr) service portal.

NOTE

You can also edit, clone and delete a Hotspot (WISPr) service portal by selecting the options **Configure**, **Clone** and **Delete** respectively, from the **Hotspot (WISPr)** tab.

Creating a Web Authentication Portal

Web authentication (also known as a “captive portal”) redirects users to a logon web page the first time they connect to this WLAN, and requires them to log on before granting access to use the WLAN.

1. Go to **Services & Profiles > Hotspots & Portals**.
2. Select the **Web Auth** tab, and then select the zone for which you want to create the portal.
3. Click **Create**.

The **Create Web Authentication Portal** page appears.

FIGURE 65 Creating a Web Authentication Portal

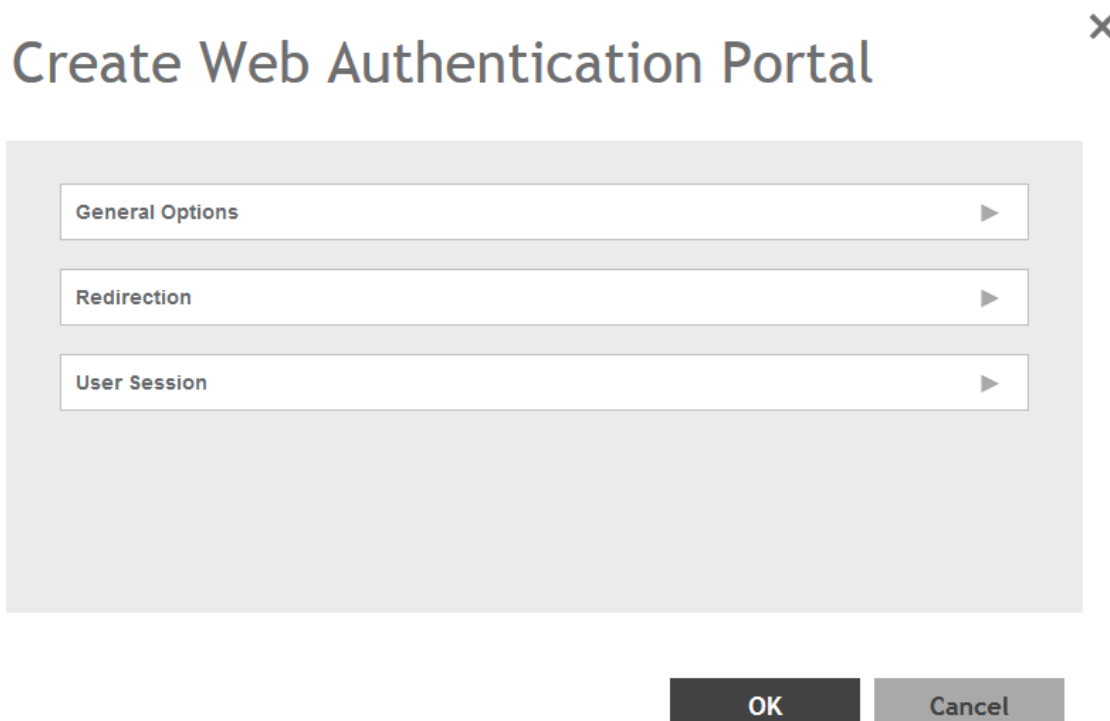

4. Configure the following:
 1. General Options
 - Portal Name: Type a name for the hotspot service portal that you are creating.
 - Portal Description: Type a short description of the hotspot service portal.
 - Language: Select the display language that you want to use on the web authentication portal.
 2. Redirection: select where to redirect the user after successfully completing authentication.
 - Start Page: select one of the following
 - Redirect to the URL that the user intends to visit: Allows the guest user to continue to their destination without redirection.
 - Redirect to the following URL: Redirect the user to a specified web page (entered into the text box) prior to forwarding them to their destination. When guest users land on this page, they are shown the expiration time for their guest pass.
 3. User Session
 - Session Timeout: Set a time limit (in minutes) after which users will be disconnected from the hotspot service and will be required to log on again.
 - Grace Period: Set the time period (in minutes) during which disconnected users are allowed access to the hotspot service without having to log on again.
5. Click **OK**.

You have completed creating a Web Auth service portal.

NOTE

You can also edit, clone and delete a Web Auth service portal by selecting the options **Configure**, **Clone** and **Delete** respectively, from the **Web Auth** tab.

Creating a WeChat Portal

WeChat is a mobile app from Tenecent that enables its users to call and send text messages to one another. If you have WeChat users on the network and you want your WLANs to support WeChat services, you can create a WeChat portal that WeChat users can use.

A WeChat portal defines the third party authentication server, also known as the equipment service provider (ESP) server, to which the controller will forward all WeChat authentication requests from wireless devices that are associated with controller-managed APs. In turn, the third party authentication server will forward these authentication requests to the WeChat server.

1. Go to **Services & Profiles > Hotspots & Portals**.
2. Select the **WeChat** tab, and then select the zone for which you want to create the portal.

Services and Profiles

Working with Hotspots and Portals

3. Click **Create**.

The **Create WeChat Portal** page appears.

FIGURE 66 Creating a WeChat Portal

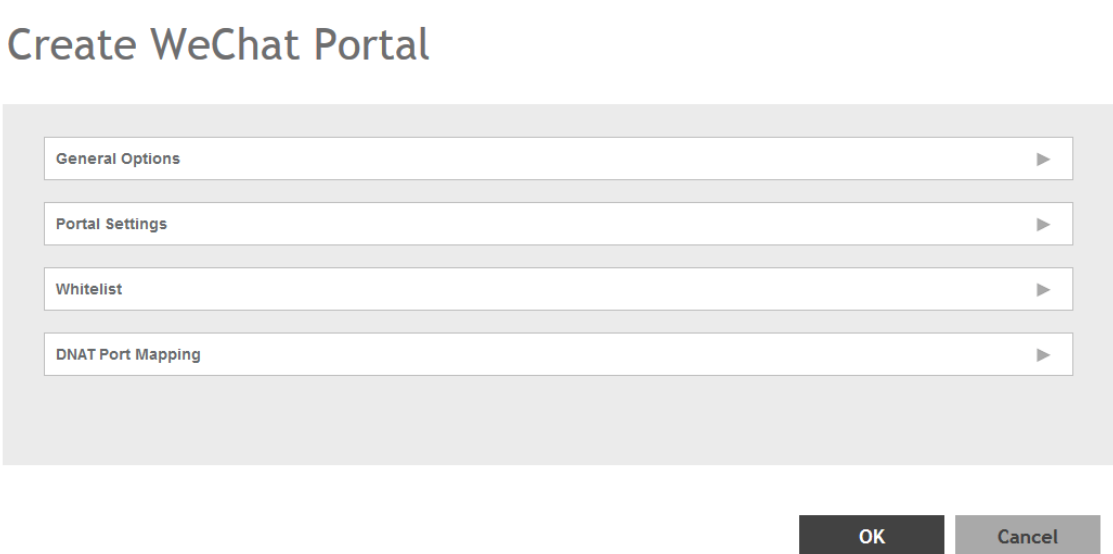

Close button (X)

Create WeChat Portal

- General Options
- Portal Settings
- Whitelist
- DNAT Port Mapping

OK Cancel

4. Configure the following:
 1. General Options
 - Name: Type a name for the portal that you are creating.
 - Description: Type a short description of the portal.
 2. Portal Settings: configure the following
 - Authentication URL: Type the authentication interface URL on the third party authentication server. When a managed AP receives a WeChat logon request from a client device, it will send the request to this authentication URL and get the authorization result.
 - DNAT Destination: Type the DNAT destination server address to which the controller will forward HTTP requests from unauthenticated client devices. The DNAT destination server and the authentication server (above) may or may not be the same server.
 - Grace Period: Type the number of minutes during which disconnected users who were recently connected will be allowed to reconnect to the portal without needing to re-authenticate. The default grace period is 60 minutes (range is between 1 and 14399 minutes).
 - Blacklist: Type network destinations that the controller will automatically block associated wireless clients from accessing. Use a comma to separate multiple entries.
 3. Whitelist: Type network destinations that the controller will automatically allow associated wireless clients to access. You can add a single entry or multiple entries.

To add a single entry, type the entry in **Wall Garden Entry**, and then click **Add**. The entry you added appears in the table below. To add multiple entries, in a comma-separated value (CSV) file, type all the network destinations that you want to add to the whitelist, and then save the CSV file. In the Whitelist section, click **Import CSV**, and then select the CSV file you created. Click **Open**. The entries in the CSV file are added to the whitelist.
 4. DNAT Port Mapping: specify at least one pair of source-to-destination port mapping. To add a port mapping, type the source and destination ports in the boxes provided, and then click **Add**. The AP will use this information to drop or forward HTTP requests from associated clients to specified ports on the DNAT server. For example, if an HTTP request from a wireless client does not originate from the specified source (from) port, the AP will discard the HTTP request. By default, a port mapping of 80-80 (source-destination) exists.
5. Click **OK**.

You have completed creating a WeChat portal.

NOTE

You can also edit, clone and delete a WeChat service portal by selecting the options **Configure**, **Clone** and **Delete** respectively, from the **WeChat** tab.

Working with Hotspot 2.0 Services

You must be aware of Hotspot 2.0 - a Wi-Fi Alliance specification that allows for automated roaming between service provider access points when both the client and access gateway support the newer protocol.

Hotspot 2.0 (also known as Passpoint™, the trademark name of the Wi-Fi Alliance certification) aims to improve the experience of mobile users when selecting and joining a Wi-Fi hotspot by providing information to the station prior to association.

This information can then be used by the client to automatically select an appropriate network based on the services provided and the conditions under which the user can access them. In this way, rather than being presented with a list of largely meaningless SSIDs to choose from, the Hotspot 2.0 client can automatically select and authenticate to an SSID based on the client's configuration and services offered, or allow the user to manually select an SSID for which the user has login credentials.

Services and Profiles

Working with Hotspots and Portals

The controller's Hotspot 2.0 implementation complies with the IEEE 802.11u standard and the Wi-Fi Alliance Hotspot 2.0 Technical Specification.

See the *Hotspot 2.0 Reference Guide for SmartZone* for information on configuring Hotspot 2.0 services, including:

- Working with Hotspot 2.0 operator profiles
- Working with Hotspot 2.0 identity providers
- Creating a Hotspot 2.0 online signup portal

Creating a Hotspot 2.0 WLAN Profile

You can assign a Hotspot 2.0 service to a Hotspot 2.0 WLAN, for which you must create a Hotspot 2.0 WLAN profile.

Follow these steps to create a Hotspot 2.0 WLAN profile.

1. Go to **Services & Profiles > Hotspots & Portals**.
2. Select the **Hotspot 2.0** tab, and then select the zone for which you want to create the profile.
3. Click **Create**.

The **Create Hotspot 2.0 WLAN Profile** page appears.

FIGURE 67 Creating a Hotspot 2.0 WLAN Profile

Create Hotspot 2.0 WLAN Profile

Identity Provider	Online Signup Service	Default
-------------------	-----------------------	---------

OK

Cancel

4. Configure the following:
 1. Name: Enter a name for this WLAN profile. This name identifies the WLAN profile when assigning an HS2.0 service to a HS2.0 WLAN.
 2. Description: Enter a description for the WLAN profile.
 3. Operator: Select the operator profile. This name identifies the service operator when assigning an HS2.0 service to a HS2.0 WLAN.

You can also click **Create** to create a Hotspot 2.0 WiFi operator. See [Creating a Hotspot 2.0 WiFi Operator Profile](#) on page 171 for more information.

4. Identity Provider: Choose one or more identity providers. Choose the identity provider. You can configure an OSU SSID when you add an Identity Provider which enables OSU and provisioning. Since there may be more than one identity provider per Hotspot 2.0 profiles having its own authentication profile, the No Match and Unspecified mapping could be duplicated. To avoid duplication, the default identity provider is taken as the correct configuration for No Match and Unspecified mapping. OSUSSID can be OSEN or OPEN [Guest].

You can also click **Create** to create a Hotspot 2.0 WiFi operator. See [Creating a Hotspot 2.0 Identity Provider](#) on page 172 for more information.

5. Advanced Options:
 - Internet Options: Specify if this HS2.0 network provides connectivity to the Internet.
 - Access Network Type: Access network type (private, free public, chargeable public, etc.), as defined in IEEE802.11u.
 - IPv4 Address: Select IPv4 address type availability information, as defined in IEEE802.11u
 - IPv6 Address: Select IPv6 address type availability information, as defined in IEEE802.11u
 - Connection Capabilities: Provides information on the connection status within the hotspot of the most commonly used communications protocols and ports.

Provide the **Protocol Name, Protocol Number, Port Number** and **Status** to **Add** a new connection.

- Custom Connection Capabilities: Allows addition of custom connection capability rules. Up to 21 custom rules can be created.

Provide the **Protocol Name, Protocol Number, Port Number** and **Status** to **Add** a new connection.

5. Click **OK**.

You have completed creating a Hotspot 2.0 WLAN profile.

NOTE

You can also edit, clone and delete a Hotspot 2.0 WLAN profile by selecting the options **Configure**, **Clone** and **Delete** respectively, from the **WLAN Profile** section in the **Hotspot 2.0** tab.

Creating a Hotspot 2.0 WiFi Operator Profile

An operator profile defines all the properties pertaining to an operator while a service profile defines the properties related to a service provider. If a WLAN is configured to provide Hotspot 2.0 service, it must be linked exactly like a Hotspot 2.0 operator profile.

1. Go to **Services & Profiles > Hotspots & Portals**.
2. Select the **Hotspot 2.0** tab, and then select the device for which you want to create the profile.

3. Click **Create**.
The **Creating Hotspot 2.0 WiFi Operator Profile** page appears.

FIGURE 68 Creating a hotspot 2.0 WiFi operator profile

Create Hotspot 2.0 Wi-Fi Operator Profile

The screenshot shows a web form titled "Create Hotspot 2.0 Wi-Fi Operator Profile". The form contains the following sections:

- Name:** A text input field.
- Description:** A text input field.
- Domain Names:** A table with one row containing a "Domain Name" input field, an "+ Add" button, an "x Cancel" button, and a trash "Delete" icon. Below the table is a "Domain Name" header and an empty input field.
- Signup Security:** A checkbox labeled "Support Anonymous Authentication (OSEN)".
- Certificate:** A dropdown menu showing "No data available" and a "+ Create" button.
- Friendly Names:** A table with one row containing a "Language" dropdown menu (set to "English"), a "Name" input field, an "+ Add" button, an "x Cancel" button, and a trash "Delete" icon. Below the table is a "Language" header and a "Name" header.

At the bottom of the form are two large buttons: "Create" and "Cancel".

4. Configure the following:
 1. **Name:** Enter a name for this Wi-Fi operator profile.
 2. **Description:** Enter a description for the venue profile.
 3. **Domain Names:** HS2.0 operator's domain name is a mandatory field, which specifies the operator's domain name. Hotspot 2.0 AP broadcasts the domain name to indicate the home Wi-Fi providers.
 4. **Signup Security:** This is an optional field and is disabled by default. Enabling would mean that operator supports secure onboarding (OSEN).
 5. **Certificate:** Select the certificate for the operator - AAA. This can be the same certificate as the one used with OSU service.
 6. **Friendly Names:** HS2.0 operator's friendly name is a mandatory field. Operator's friendly name is displayed on mobile client's screen. It is also used for operator verification during secure onboarding (OSEN). Select the display language from the drop down list.
5. Click **OK**.

Creating a Hotspot 2.0 Identity Provider

The Hotspot 2.0 Identity provider provides authentication, accounting and online sign-up service. There can be one or more identity providers per Hotspot 2.0 access WLAN.

To configure the HS 2.0 identity provider, you must configure the following:

Network Identifier

Follow these steps to create a Hotspot 2.0 Identity Provider - Network Identifier.

1. Configure the following:
 1. Name: Enter a name or this network identifier profile.
 2. Description: Enter a description for the network identifier profile.
 3. PLMNs: Each record contains MCC and MNC.

MCC: Set the correct country code for the geographical location. This is required when the controller sends MAP authentication information. Type the mobile country code digits. Decimal digit strings with maximum length of 3 and minimum length of 2.

MNC: Set the mobile network code based on the geographical location. This is required when controller sends MAP authentication information. Type the mobile network code digits. Decimal digit strings with maximum length of 3 and minimum length of 2.
 4. Realms: List of NAI realms corresponding to service providers or other entities whose networks or services are accessible via this AP. Up to 16 NAI realm entries can be created. Each NAI realm entry can contain up to four EAP methods. You can add a realm by providing the realm **Name**, **Encoding technique** (choose between RFC-4282 and UTF-8) and **EAP Methods**.
 5. Home OIs: Organization Identifier (OI) is a unique value assigned to the organization. User can configure a maximum of 12 OI values and can adjust the order since the AP takes only 3 OIs in the beacon.
2. Click **Next**.

You have completed creating a Hotspot 2.0 Identity Provider - Network Identifier.

Online Signup and Provisioning

Follow these steps to create a Hotspot 2.0 Identity Provider - Online Signup and Provisioning.

1. Configure the following:
 1. Provisioning Options
 - Provisioning Service: The provisioning service is responsible for any subscription provisioning process in which messages are communicated between the UE and the SZ resulting in a PPS-MO provisioned into the UE. The provisioning supports both SOAP-XML and OMA-DM as communication protocols for the process based on the initial request coming from the UE. The provisioning service supports sign-up; remediation and policy update flows where the UE is provisioned with a full PPS -MO or only with internal node/s of the PPS-MO. Administrator can only set External Internal Provisioning Services. , where the administrator is required to fill the external OSU server URL.
 - Provisioning Protocol: Select communication protocols OMA-DM or SOAP-XML.
 2. Online Signup Options
 - OSU NAI Realm: This configuration is only for External Provision Service. In case of Internal Provisioning Service, the NAI realm should be configured per authentication service, which is available during on-boarding.
 - Common Language Icon: This is the default icon presented in the device for this identity provider in case the device does not find any match for other icons per language in the table.
 - OSU Service Description: This table configures the friendly name, description and icon per language. This information is presented on the device when it receives ANQP message which includes OSU providers. Friendly names, which are required to be part of the OSU certificate is automatically populated in this table. In case description is also included in the OSU certificate it is automatically populated into the table. Administrators are required to set the matched icon per language as included in the OSU certificate.
 - Whitelisted Domain: Add the domain names of the External Portal domain.
2. Click **Next**.

You have completed creating a Hotspot 2.0 Identity Provider - Online Signup and Provisioning.

Services and Profiles

Working with Hotspots and Portals

Authentication

Follow these steps to create a Hotspot 2.0 Identity Provider - Authentication.

1. Configure the following:
 1. Realm: configure the realm mapping to the authentication service.
 2. Auth Service: map the realm to an external RADIUS server which should be pre-configured.
 3. Dynamic VLAN ID: type the VLAN ID.
2. Click **Next**.

You have completed creating a Hotspot 2.0 Identity Provider - Authentication.

Accounting

Follow these steps to create a Hotspot 2.0 Identity Provider - Accounting.

1. Configure the following:
 1. Realm: if the authentication's realm is set as remote credential type, administrator should set this realm here to the customer's external accounting server.
 2. Accounting Service: select the accounting service.
2. Click **Next**.

You have completed creating a Hotspot 2.0 Identity Provider - Accounting.

Review

Review the configuration on the page before committing the changes to the server. Click **Create** to create the Hotspot 2.0 Identity Provider.

Creating a Hotspot 2.0 Venue Profile

The Hotspot 2.0 technology allows users to seamlessly roam between the provider's home Wi-Fi network and the visited Wi-Fi network in a different location. A Wi-Fi provider can partner with several roaming partners to provide Wi-Fi access to partner's subscribers. Public venues such as institutions, restaurants, and stadiums are considered roaming partners.

1. Go to **Services & Profiles > Hotspots & Portals**.
2. Select the **Hotspot 2.0** tab, and then select the zone for which you want to create the profile.

3. Click **Create**.
The **Create Hotspot 2.0 Venue Profile** page appears.

FIGURE 69 Creating a Hotspot 2.0 Venue Profile

Create Hotspot 2.0 Venue Profile

The screenshot shows the 'Create Hotspot 2.0 Venue Profile' form. It features the following elements:

- Name:** A text input field.
- Description:** A text input field.
- Venue:** A dropdown menu currently showing 'Venue'.
- Venue Names:** A table with two columns: 'Language' and 'Name'. The 'Language' column has a dropdown menu set to 'English'. The 'Name' column has a text input field. To the right of the table are three buttons: '+ Add', 'x Cancel', and a trash icon labeled 'Delete'.
- Venue Category:** Two dropdown menus: 'Group' (set to 'Unspecified') and 'Type' (set to 'Unspecified').
- Buttons:** 'OK' and 'Cancel' buttons at the bottom right.

4. Configure the following:
 1. **Name:** Enter a name for this venue profile. This name identifies the venue profile when assigning an HS2.0 service to a HS2.0 venue.
 2. **Description:** Enter a description for the venue profile.
 3. **Venue:**
 - **Venue Names:** Create a new venue name. Select the language and enter the venue name in that language.
 - **Venue Category:** Select venue group and venue type as defined in IEEE802.11u, Table 7.25m/n.
 - **WAN Metrics:** Provides information about the WAN link connecting an IEEE 802.11 access network and the Internet; includes uplink/downlink speed estimatesSelect the operator profile. This name identifies the service operator when assigning an HS2.0 service to a HS2.0 WLAN.
5. Click **OK**.

You have completed creating a Hotspot 2.0 WLAN profile.

NOTE

You can also edit, clone and delete a Hotspot 2.0 venue profile by selecting the options **Configure**, **Clone** and **Delete** respectively, from the **Venue Profile** section in the **Hotspot 2.0** tab.

Creating a UA Blacklist Profile

The controller automatically blocks certain user agents (or software used by a user) from accessing hotspots provided by controller-managed APs. When the controller blocks any of these user agents, an error message appears on the user device. You can add to or remove user agents from this blacklist.

Following are some of the blocked user agents:

- ZoneAlarm

Services and Profiles

Working with Hotspots and Portals

- VCSOapClient
- XTier NetIdentity
- DivX Player
- Symantec LiveUpdate
- Windows Live Messenger
- StubInstaller
- windows-update-agent
- Windows Live Essentials
- Microsoft Dr. Watson for Windows (MSDW)
- Avast Antivirus Syncer
- Microsoft Background Intelligent Transfer Service (BITS)
- Google Update
- TrendMicro client
- Skype WISPr

1. Go to **Services & Profiles > Hotspots & Portals**.
2. Select the **UA Blacklist** tab, and then select the zone for which you want to create the portal.
3. Click **Create**.

The **Creating a UA Blacklist Profile** page appears.

FIGURE 70 Creating a UA Blacklist Profile

Create UA Blacklist Profile

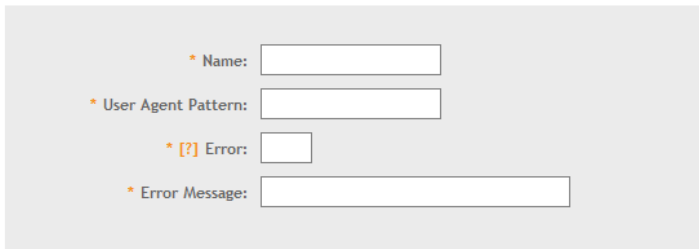

* Name:

* User Agent Pattern:

* [?] Error:

* Error Message:

OK

Cancel

4. Configure the following:
 1. Name: Type a name of the user agent.
 2. User Agent Pattern: Type the agent pattern.
 3. Error: Specify the error message number.
 4. Error Message: Specify the error message.
5. Click **Create**.

You have completed creating a UA Blacklist Profile

NOTE

You can also edit, clone and delete a UA blacklist profile by selecting the options **Configure**, **Clone** and **Delete** respectively, from the **UA Blacklist** tab.

Configuring Access Control

SmartZone's Access Control features provide a wide range of options to control access and utilization of the wireless network.

Creating a User Traffic Profile

A User Traffic Profile (UTP) can be created to block or limit user traffic based on a number of factors, including Source IP address, Port, Destination IP address, Protocol, etc. Additionally, a UTP can be created to shape traffic according to a configurable Application Control Policy.

Once the UTP is created, it can be applied to any WLAN from the **Wireless LANs** page.

1. Go to **Services & Profiles > Access Control**.
2. Select the **User Traffic** tab, and then select the zone for which you want to create the profile.
3. Click **Create**. The **Create User Traffic Profile** page appears.

FIGURE 71 Create User Traffic Profile

4. Configure the following:
 1. **Name:** Type a name for the user profile.
 2. **Description:** Type a short description for this profile.
 3. **Rate Limiting:** Specify and apply rate limit values for the user profile to control the data rate. Select the **Enable** check-box to set the *Uplink* and *Downlink* rate limit values.
5. To create traffic control rules, click **Create** in the **Traffic Access Control List** section, and then configure Traffic Control Rules as required. For **Default Access**, select whether to **Allow** or **Block** access if no rule is matched. See [Creating a User Traffic Access Control Rule](#) on page 178 for more information.
6. In **Application Recognition and Control**, select an **Application Policy** from the list, or click **Create** to create a new policy. For more information, see [Configuring Application Controls](#) on page 189.

7. Click **OK** to save the User Traffic Profile.

You have completed creating a UTP. You can now assign this traffic profile to a WLAN from the **Wireless LANs** page.

NOTE

You can also edit, clone and delete a profile by selecting the options **Configure**, **Clone** and **Delete** respectively, from the **User Traffic** tab.

Creating a User Traffic Access Control Rule

User Traffic Profiles consist of multiple traffic control rules, which can be enforced in any order you prefer (click up or down arrows to rearrange rules).

To create a user traffic control rule:

1. Click **Create**. The **Create User Traffic Access Control Rule** page appears.

FIGURE 72 Creating a User Traffic Access Control Rule

Create User Traffic Access Control Rule

The screenshot shows a configuration window titled "Create User Traffic Access Control Rule". The form contains the following fields and options:

- Description: [Text input field]
- Access: [Dropdown menu, selected "Allow"]
- Source IP: [Checked] Subnet Network Address: [Text input field] Subnet Mask: [Text input field]
- Source Port: [Checked] Range [Text input field] - [Text input field]
- Destination IP: [Checked] Subnet Network Address: [Text input field] Subnet Mask: [Text input field]
- Destination Port: [Checked] Range [Text input field] - [Text input field]
- Protocol: [Dropdown menu, selected "No data available"]
- Direction: Only upstream access control rule is supported

At the bottom right of the window are two buttons: "OK" and "Cancel".

2. Configure the following:
 - **Description:** Type a short description for the user traffic rule.
 - **Access:** Select Allow or Block depending on whether you want to set this rule as the default rule.
 - **Source IP:** Specify the source IP address to which this rule will apply. To apply this rule to an IP address range, type the network address and the subnet mask. To apply this rule to a single IP, clear the **Subnet** check box, and then enter the IP address.
 - **Source Port:** Specify the source port to which this rule will apply. To apply this rule to a port range, type the starting and ending port numbers in the two boxes. To apply this rule to a single port number, clear the **Range** check box, and then enter the port number.
 - **Destination IP:** Specify the destination IP address to which this rule will apply. To apply this rule to an IP address range, type the network address and the subnet mask. To apply this rule to a single IP, clear the **Subnet** check box, and then enter the IP address.
 - **Destination Port:** Specify the source port to which this rule will apply. To apply this rule to a port range, type the starting and ending port numbers in the two boxes. To apply this rule to a single port number, clear the **Range** check box, and then enter the port number.
 - **Protocol:** Select the network protocol to which this rule will apply. Supported protocols include TCP, UDP, UDPLITE, ICMP (ICMPv4), ICMPV6, IGMP, ESP, AH, SCTP.
3. Click **OK** to save your changes.

Creating OS Policy Service

You can control how devices installed with certain OS configurations can be connected to the network, and also control what they can be allowed to do within the network. Using the OS policy service, the system can identify the type of client attempting to connect, and perform control actions such as allow/block, rate limiting, and VLAN tagging based on the OS rule.

1. Go to **Services & Profiles > Access Control**.
2. Select the **OS Policy** tab, and then select the zone for which you want to create the policy.

3. Click **Create**.
The **Create OS Policy Service** page appears.

FIGURE 73 Creating an OS Policy Service

Create OS Policy Service

General Options

* Name:

Description:

* Default Access: Default access if no rule is matched: Allow Block

Rules

+ Create Configure Clone Delete

Description	Device Type	Access	Uplink Rate Limit	Downlink Rate Limit	VLAN

OK Cancel

4. Configure the following:
 1. Name: Type a name for the OS policy.
 2. Description: Type a short description for this OS policy.
 3. Default Access: select either Allow or Block. This is the default action that the system will take if no rules are matched.
 4. Rules: Define the OS Policy rules. For more information see, [Creating OS Policy Rules](#) on page 181
 5. Click **OK**.

You have created the OS policy service.

NOTE

You can also edit, clone and delete a service by selecting the options **Configure**, **Clone** and **Delete** respectively, from the **OS Policy** tab.

Creating OS Policy Rules

You can create rules for every OS policy service that you create.

1. Click **Create**. The **Create OS Policy Rule** page appears.

FIGURE 74 Create OS Policy Rule

2. Configure the following:
 - Description: Type a short description for the rule.
 - Access: Select Allow or Block. This is the action that the system will take if the client matches any of the attributes in the rule.
 - Device Type: Select from any of the supported OS types.
 - Rate Limiting: Specify and apply rate limit values for the device.
Select the **Enable** check-box to set the *Uplink* and *Downlink* rate limit values.
 - VLAN: Segment this client type into a specified VLAN (1~4094; if no value is entered, this policy does not impact device VLAN assignment).
 - Click **OK**.

You have created the OS policy rule.

VLAN Pooling

When Wi-Fi is deployed in a high density environment such as a stadium or a university campus, the number of IP addresses required for client devices can easily run into the thousands. Placing thousands of clients into a single large subnet or VLAN can result in degraded performance due to factors like broadcast and multicast traffic. VLAN pooling is adopted to address this problem.

VLAN pooling allows administrators to a deploy pool of multiple VLANs to which clients are assigned, thereby automatically segmenting large groups of clients into multiple smaller subgroups, even when connected to the same SSID. As the client device joins the WLAN, the VLAN is assigned to one of the VLANs in the pool based on a hash of the client's MAC address. To use the VLAN pooling feature, you first need to create a VLAN pooling profile, and then you can assign the profile to a specific WLAN or override the VLAN settings of a WLAN group.

NOTE

AP model: 11ac wave 2 supports a maximum of 64 VLANs. Other AP models support up to 32 VLANs.

Creating a VLAN Pooling Profile

Each VLAN pool can contain up to 16 VLANs, and a maximum of 64 VLAN pools can be created. Each WLAN can be configured with a single VLAN pool.

1. Go to **Services & Profiles > Access Control**.
2. Select the **VLAN Pooling** tab, and then select the zone for which you want to create the profile.
3. Click **Create**.

The **Create VLAN Pooling** page appears.

FIGURE 75 Creating a VLAN Pooling Profile

Create VLAN Pooling Profile X

* Name:

Description:

* [?] VLANs:

* Option: MAC Hash

OK **Cancel**

4. Configure the following:
 1. Name: Type a name for the VLAN profile.
 2. Description: Type a short description for this profile.
 3. VLANs: Type the VLAN IDs to be assigned to this pool. VLAN IDs can be separated by hyphens, commas, or a combination (for example, 7-10, 13, 17, 20-28).
 4. Click **OK**.

You have created the VLAN Pooling profile.

NOTE

You can also edit, clone and delete a profile by selecting the options **Configure**, **Clone** and **Delete** respectively, from the **VLAN Pooling** tab.

Create Precedence Profile

Clients are assigned to VLANs by various methods, and there is an order of precedence by which VLANs are assigned. The assignment is commonly done from lowest to highest precedence. You can also set precedence for Rate limiting attribute of the profile.

NOTE

Each WLAN has a default precedence.

1. Go to **Services & Profiles > Access Control**.
2. Select the **Precedence** tab, and then select the zone for which you want to create the policy.
3. Click **Create**.

The **Create Precedence Profile** page appears.

FIGURE 76 Creating a Create Precedence Profile

Create Precedence Profile

* Name:

VLAN Precedence ▼

↑ Up ↓ Down

Priority	Description
1	AAA
2	DEVICE
3	WLAN

OK Cancel

4. Configure the following:
 1. Name: Type the name of the profile.
 2. VLAN Precedence: Use the Up and Down options to set the VLAN priority.
 3. Rate Limiting Precedence: Use the Up and Down options to set the Rate Limit priority.

NOTE

When SSID Rate Limiting (restricts total usage on WLAN) is enabled, per-user rate limiting is disabled.

4. Click **OK**.

You have created the Precedence profile.

NOTE

You can also edit, clone and delete a profile by selecting the options **Configure**, **Clone** and **Delete** respectively, from the **Precedence** tab.

Creating an L2 Access Control Service

Another method to control access to the network is by defining Layer 2/MAC address access control lists (ACLs), which can then be applied to one or more WLANs or WLAN groups. L2 ACLs are either allow-only or deny-only; that is, an ACL can be set up to allow only specified clients or to deny only specified clients. MAC addresses that are in the deny list are blocked at the AP.

1. Go to **Services & Profiles > Access Control**.
2. Select the **L2 Access Control** tab, and then select the zone for which you want to create the access control service.
3. Click **Create**.

The **Create L2 Access Control Service** page appears.

FIGURE 77 Creating an L2 Access Control Service

Create L2 Access Control Service

The screenshot shows the 'Create L2 Access Control Service' configuration page. It features a 'General Options' section with a 'Name' field, a 'Description' field, and a 'Restriction' section with two radio buttons: 'Allow only the stations listed below' (selected) and 'Block only the stations listed below'. Below this is a 'Rules' section with a 'MAC Address' input field, an '+ Add' button, an 'Import CSV' button, a 'Cancel' button with an 'X' icon, and a 'Delete' button with a trash icon. At the bottom of the form is a table with one row and one column labeled 'MAC Address'. At the bottom right of the form are two large buttons: 'OK' and 'Cancel'.

4. Configure the following:
 1. General Options:
 - Name: Type a name for this policy.
 - Description: Type a short description for this policy.
 - Restriction: Select the default action that the controller will take if no rules are matched. Available options include: **Allow only the stations listed below** or **Block only the stations listed below**.
 2. Rules:
 - MAC Address: Type the MAC address to which this L2 access policy applies.
 3. Click **OK**.

You have created an L2 access policy.

NOTE

You can also edit, clone and delete a policy by selecting the options **Configure**, **Clone** and **Delete** respectively, from the **L2 Access Control** tab.

Creating Blocked Clients

You can deny access to the network for certain clients by using the block client access control feature.

1. Go to **Services & Profiles > Access Control**.
2. Select the **Blocked Client** tab, and then select the zone for which you want to block the client access.

3. Click **Create**.
The **Create Blocked Client** page appears.

FIGURE 78 Create Blocked Client

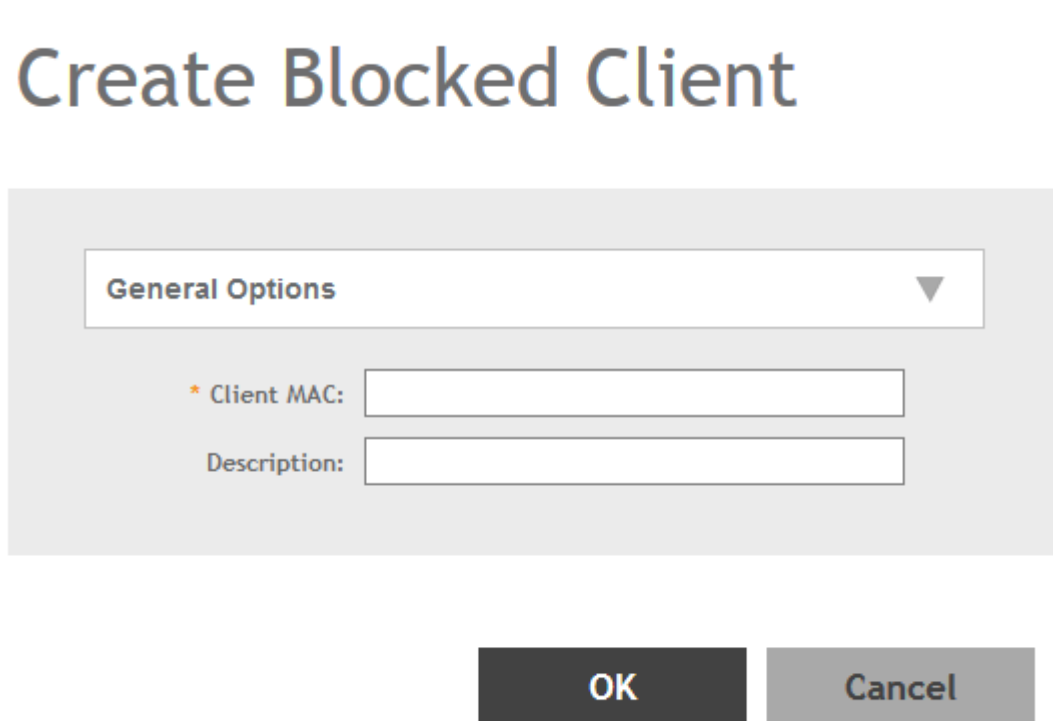

Create Blocked Client ✕

General Options ▼

* Client MAC:

Description:

OK **Cancel**

4. Configure the following:
 1. Client MAC: Type MAC address of the client that you want to block.
 2. Description: Type a short description for client.
 3. Click **OK**.

You have created the blocked client list.

NOTE

You can also edit, clone and delete a list by selecting the options **Configure**, **Clone** and **Delete** respectively, from the **Blocked Client** tab.

Creating a Client Isolation Whitelist

This feature allows the administrator to manually specify an approved list of wired destinations that may be reachable by wireless clients.

NOTE

The whitelist only applies to destinations that are on the wired network, and it will not work on wireless destinations.

1. Go to **Services & Profiles > Access Control**.
2. Select the **Client Isolation Whitelist** tab, and then select the zone for which you want to specify the list of approved clients.

3. Click **Create**.
The **Create Client Isolation Whitelist** page appears.

FIGURE 79 Creating a Client Isolation Whitelist

Create Client Isolation Whitelist

* Name:

Description:

Auto Whitelist: APs will auto-discovery gateway devices and add them to the isolation whitelist.

Client Entries ▼

MAC	IP Address	Description

4. Configure the following:
 1. Name: Type a name for the client.
 2. Description: Type a short description about the client.
 3. Auto Whitelist: Select this check-box if you want the AP to automatically scan for devices and include them to the whitelist.
 4. Client Entries: To add the clients to the list, click **Create** and provide client information such as MAC address (mandatory), IP address and Description.
 5. Click **OK**.

You have created the list of whitelisted clients that can access the network.

NOTE

You can also edit, clone and delete the list by selecting the options **Configure**, **Clone** and **Delete** respectively, from the **Client Isolation Whitelist** tab.

Creating Time Schedules

You can control client access to the network by providing a time schedule within which the device can access the network.

1. Go to **Services & Profiles > Access Control**.
2. Select the **Time Schedule** tab, and then select the zone for which you want to create the schedule.

3. Click **Create**.
The **Create Time Schedule Table** page appears.

FIGURE 80 Creating a Time Schedule Table

Create Time Schedules Table

* Schedule Name:

Schedule Description:

	AM											PM											
Time	1	2	3	4	5	6	7	8	9	10	11	12	1	2	3	4	5	6	7	8	9	10	11
Sun																							
Mon																							

4. Configure the following:
 1. Schedule Name: Type a name for the schedule you want to create.
 2. Schedule Description: Type a short description for this schedule.
 3. Draw the schedule table.
 4. Click **OK**.

You have created the schedule.

NOTE

You can also edit, clone and delete the schedule by selecting the options **Configure**, **Clone** and **Delete** respectively, from the **Time Schedule** tab.

Creating a DNS Server Profile

By creating a DNS server profile, you can specify the primary and secondary address of the DNS server that will be used to transmit data packets to the DNS server.

1. Go to **Services & Profiles > Access Control**.
2. Select the **DNS Servers** tab, and then select the zone for which you want to create the profile.

3. Click **Create**.
The **Create DNS Server Profile** page appears.

FIGURE 81 Creating a DNS Server Profile

Create DNS Server Profile

* Name:

Description:

* Primary DNS IP:

Secondary DNS IP:

OK **Cancel**

4. Configure the following:
 1. Name: Type a name for the DNS server profile.
 2. Description: Type a short description for profile.
 3. Primary DNS IP: Type the primary DNS IP address.
 4. Secondary DNS IP: Type the secondary DNS IP address.
 5. Click **OK**.

You have created the DNS Server Profile.

NOTE

You can also edit, clone and delete the profile by selecting the options **Configure**, **Clone** and **Delete** respectively, from the **DNS Servers** tab.

Configuring Application Controls

Using the **Application Control** screen, you can identify, control, and monitor applications that are running on wireless clients associated with managed APs, and you can also apply filtering policies to prevent users from accessing certain applications.

Additionally, you can create your own user-defined applications, import an updated application signature package, and configure rate limiting and QoS traffic shaping policies based on system-defined or user-defined applications.

Creating an Application Control Policy

You can create an application policy to limit traffic by application, to classify traffic into priority queues using QoS traffic shaping rules, or to completely block access to an application.

To create an application policy:

1. Go to **Services & Profiles > Application Control**.
2. Select the **Application Policy** tab.
3. Click **Create**.

The **Create Application Policy** page appears.

FIGURE 82 Creating an Application Policy

Create Application Policy

Note: Please ensure that configuration is consistent with URL filtering policy. The URL filtering policy will take precedence.

The screenshot shows the 'Create Application Policy' configuration page. It features a 'General Options' section with input fields for 'Name' and 'Description'. Below this is a 'Rules' section containing three buttons: '+ Create', 'Configure', and 'Delete', and a table with columns for '#', 'Rule Type', and 'Content'. The 'Logging' section at the bottom includes two checkboxes: 'Send App Logs to SZ' and 'Enable Remote Syslog', each with a sub-option 'Allow the AP to log every application event and end the events to SmartZone' or 'external syslog'. 'OK' and 'Cancel' buttons are located at the bottom right of the form.

4. Enter a **Name** and optionally a **Description** for the policy.

- In **Rules**, click **Create** to create a new rule. Each application policy can contain up to 32 rules.
The **Create Application Policy Rule** page appears.

FIGURE 83 Creating an Application Policy Rule

The screenshot shows a dialog box titled "Create Application Policy Rule" with a close button (X) in the top right corner. The dialog contains three dropdown menus:

- Rule Type:** Denial Rules
- Application Type:** System Defined
- Application:** Instant messaging (with a sub-field containing MSN)

At the bottom of the dialog are two buttons: **OK** and **Cancel**.

- Configure the following:
 - Rule Type:** Enter the type of rule from options: Denial Rules, QoS and Rate Limiting.
 - Application Type:** Select whether the application is user defined or system defined.
 - Application:** Select the application for which you want to create a policy rule.
- Click **OK** to save the rule.
If a rule is already created, you can edit its configuration settings by selecting it, and clicking **Configure** as shown in the **Create Application Policy** screen.
- In **Logging**, select the appropriate check-box for the AP to log events:
 - Allow the AP to log every application event and end the events to SmartZone
 - Allow the AP to log every application event and end the events to external syslog
- Click **OK** to save the application policy.

You have created an application policy.

Next, you can continue to apply the application control policy to user traffic, as described in [Implementing an Application Control Policy](#) on page 191.

Implementing an Application Control Policy

Deploying an application control policy involves configuring a User Traffic Profile (UTP) with the policy, and then applying that profile to a WLAN.

To implement an Application Control Policy:

- Go to **Services and Profiles > Access Control > User Traffic**.
- Click **Create**. The **Create User Traffic Profile** form appears.
- Enter a **Name**, and optionally a **Description** for the UTP.
- In the **Application Recognition and Control** section, select an **Application Policy** from the drop-down list. Alternatively, click **Create** to create a new policy.
- Click **OK** to save the User Traffic Profile.

Services and Profiles

Configuring Application Controls

6. Go to **Wireless LANs**.
7. Locate the WLAN for which you want to apply the application policy, and select it from the list.
8. Click **Configure**. The **Edit WLAN [WLAN Name]** form appears.
9. Expand the **Advanced Options** section, and select a **User Traffic Profile** you created from the drop-down list. Alternatively, click **Create** to create a new UTP.

10. Click **OK** to save your WLAN changes.

FIGURE 84 Create a User Traffic Profile (UTP)

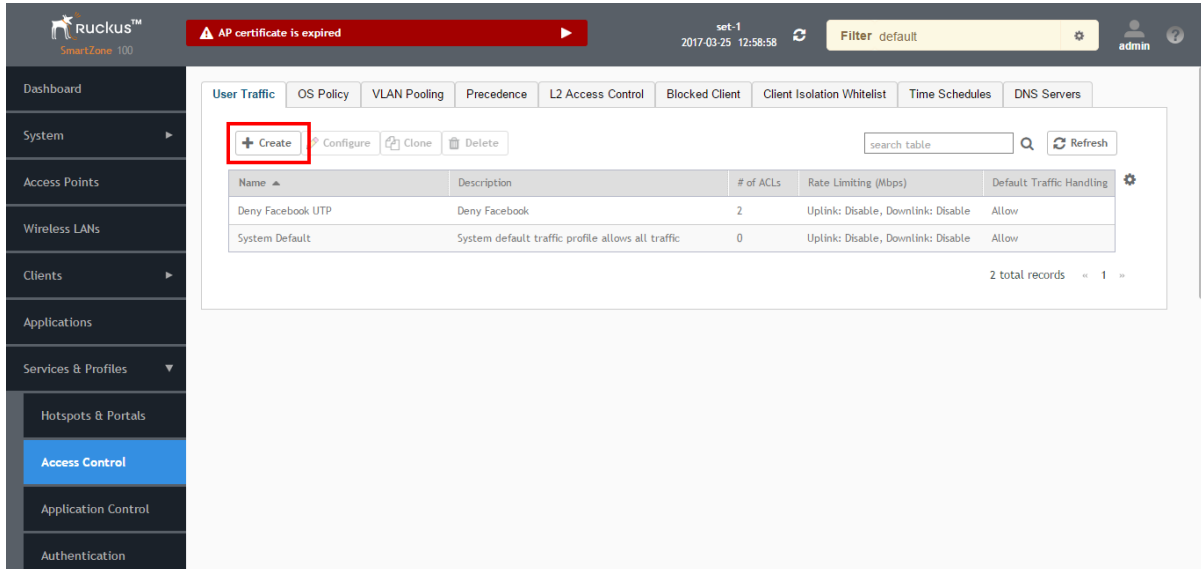

FIGURE 85 Select an Application Policy to apply to this UTP

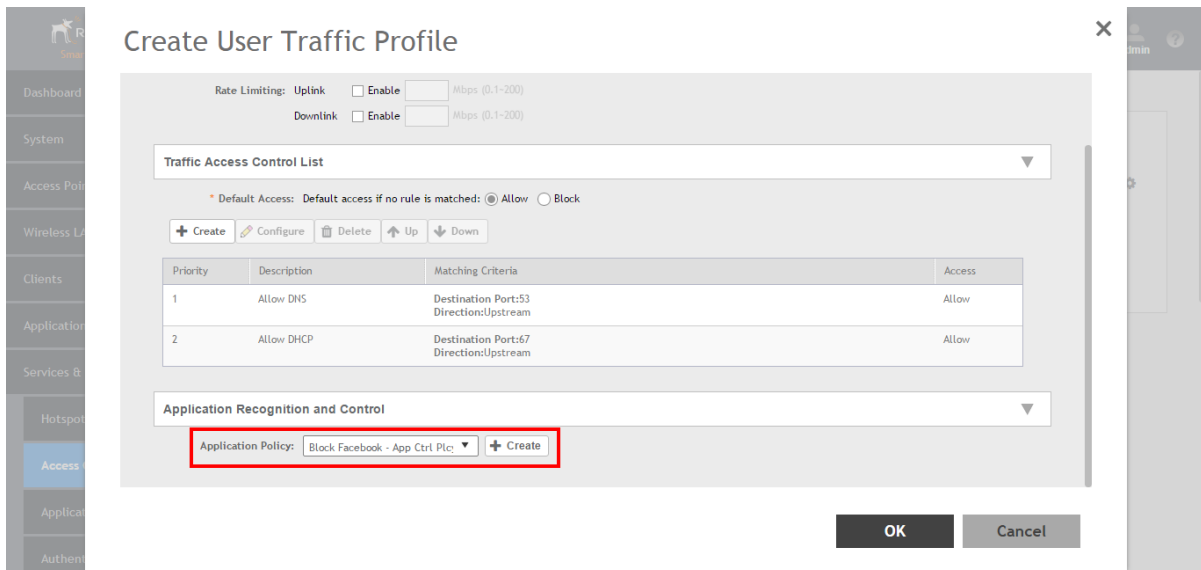
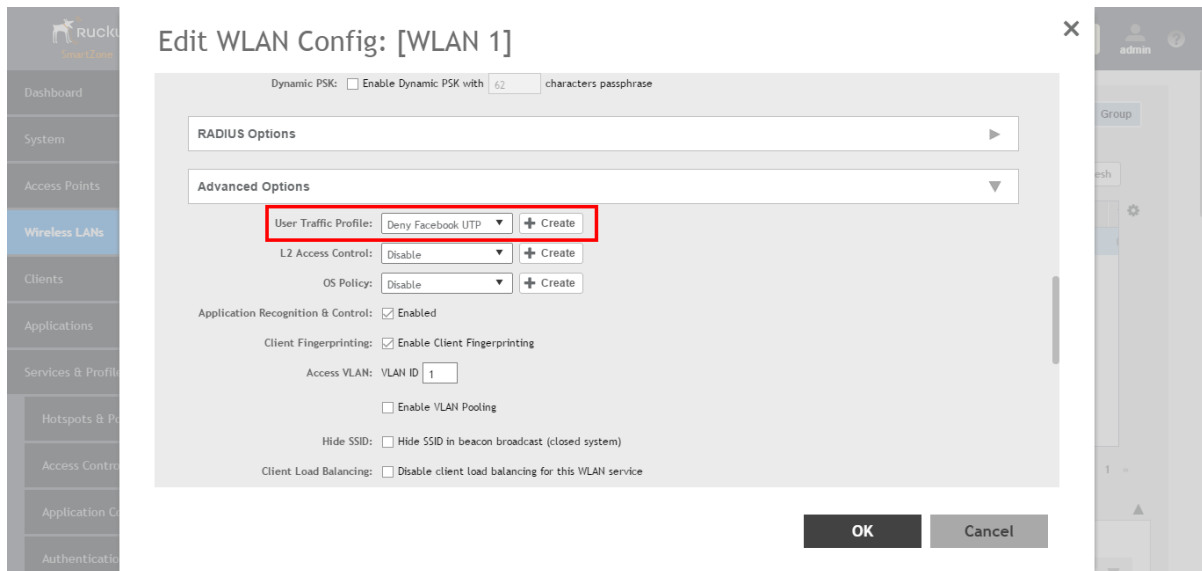

FIGURE 86 Apply the UTP to a WLAN



Creating a User Defined Application

When an application is unrecognized and generically (or incorrectly) categorized, the controller will be unable to monitor its traffic, unless you configure an explicit application identification policy based on IP address/mask, port and protocol.

To configure a user-defined application:

1. Go to **Services & Profiles > Application Control**.
2. Select the **User Defined** tab.

3. Click **Create**.
The **Create User Defined Application** page appears.

FIGURE 87 Creating a User Defined Application

Create User Defined Application X

* Name:

* Type: Default Port Mapping Only

* Destination IP:

* Netmask:

* Destination Port:

* Protocol: TCP ▼

OK Cancel

4. Configure the following:
 1. **Name:** Type a name for the application. This is the name that will identify this application on the dashboard.
 2. **Type:** Select Default or Port Mapping Only (destination port).
 3. **Destination IP:** Type the destination IP address of the application.
 4. **Netmask:** Type the netmask of the destination IP address.
 5. **Destination Port:** Type the destination port for the application.
 6. **Protocol:** Select the protocol used by the application. Options include TCP and UDP.
 7. Click **OK**.

You have created the user defined application.

NOTE

You can also edit, clone and delete the application policy by selecting the options **Configure**, **Clone** and **Delete** respectively, from the **User Defined** tab.

Importing an Application Signature Package

Ruckus Wireless will periodically release and make new application signature packages available for download.

Step 1: Uploading the Signature Package

Once you have downloaded a new signature package, you can import it into SmartZone using the following procedure:

1. Go to **Services & Profiles > Application Control**.
2. Select the **Signature Package** tab.

FIGURE 88 Viewing and Uploading Signature Package File Information

Current Signature Package Info	
File Name	RuckusSigPack-1.064
File Size	585.6KB
Version	1.64

Upload Signature Package

Upload the Application Signature Package file (*.tar.gz).

3. The **Current Signature Package Info** section displays the information about the signature package file name, size and version.
4. In **Upload Signature Package**, click **Browse** to select the file.
5. Click **Upload** to upload the file.

Once the import is complete, the list of system-defined applications is updated immediately.

Step 2: Validating the Signature Package

The application updates the latest signature package in all the connected APs. To validate the latest version follow the procedure:

1. In the Access Point, enter the Privileged EXEC mode using CLI.

2. Enter the following CLI command, which displays the latest version of the signature package.

```
rkscli:get tdts-sigpack
```

```
Current TDTS Signature Package is Ruckus-SigPack-Ver-x.xx.trf
```

```
OK
```

URL Filtering

Administrators can use the URL filtering feature to block access to inappropriate websites. The Web pages available on the internet are classified into different categories, and those identified to be blocked can be configured based on available categories. Administrators can also create policies based on these categories, to allow or deny user access.

After categorizing websites accessed by the clients connected to the AP, a third-party cloud hosted URL categorization service called *Webroot Brightcloud URL categorization* is used to categorize the live web traffic generated from the client devices. By default, traffic which is not categorized is allowed. The packets from the client device are dropped only after the URL is successfully categorized, and DENY is configured for the client in the policy.

The AP periodically generates statistics such as the Top 10 Denied URLs/categories, Top 10 URLs/categories by traffic and sends them to controller which collects this information and maintains it based on the filters applied per Zone and WLAN.

URLs are typically classified by third-party applications to enhance internet security and usage. To categorize the web page or URL, the network packets must be analyzed. In HTTP packets, the complete URL value is extracted and in HTTPS packets, the domain name of the URL is extracted for URL web page categorization. The AP remembers the signature of the packet it forwards and when the packet is identified as HTTP or HTTPS, it receives the domain name/URL from the packet and sends it to the *Webroot Brightcloud Web Classification* engine to verify the Web category. If the retrieved category is blocked as per the configured policy, packets with the same signature are blocked.

The AP maintains a cache of up to 80000 URL entries and attempts to find the URL category from the local cache. It contacts the Webroot server only when the URL is not available in the local cache.

Limitations

Following are some limitations of this feature:

- If multiple domains resolve to a single IP address, URL categorization can be inaccurate.
- Currently, if a website is blocked by URL filtering, you will not know why it is not open as a **DENY page**, as redirection is not available.
- This feature requires internet connectivity as it needs to connect to the webroot server to get the URL categories.

Viewing a Summary of URL Filters

The **Summary** page provides administrators with a view to analyze URL traffic based on the user activity over the network.

You can view the top ten URLs by:

- Traffic - displays all URLs accessed (including blocked URLs) the most
- Categories Traffic - displays all categories accessed (including blocked categories) the most
- Clients Traffic - displays all clients accessed (including blocked clients) the most
- Blocked URLs - displays the URLs that have been denied access the most

Services and Profiles

URL Filtering

- Blocked Categorize - displays the URL categories that have been denied the most
- Blocked Clients - displays the clients that have been denied access the most

Creating a URL Filtering Policy

Administrators can create URL filtering policies and reuse them across WLAN controllers. You can define the policy based on the web page categorization, whitelist, blacklist and web search.

Policies can also be created based on the role assigned to the user. Users can be allowed or denied access to a particular URL based on the role assigned, and the SSID login details for that role.

Follow these steps to create a URL filtering policy:

1. Go to **Services & Profiles > URL Filtering**.

- Select the **Profiles** tab, and then click **Create**.
The **Create URL Filtering Policy** page appears.

FIGURE 89 Creating a URL Filtering Policy

Create URL Filtering Policy

General Options

Blocked Categories

No adult content No adult content or nudity
 Clean and safe No adult content plus, no malware, spyware, phishing, botnet or spamware
 Child and student friendly Clean and safe plus no alcohol, intimate apparel, dating, or weapons
 Strict Child and student friendly plus no streaming media, personal storage and, games
 Custom Please chose the contents you want to block in below checkbox group

Blocked Categories

[Select All](#) [None](#)

<input checked="" type="checkbox"/> Abortion	<input type="checkbox"/> Entertainment and Arts	<input type="checkbox"/> Job Search	<input type="checkbox"/> Personal Storage	<input type="checkbox"/> Society
<input type="checkbox"/> Abused Drugs	<input type="checkbox"/> Fashion and Beauty	<input checked="" type="checkbox"/> Keyloggers and Monitoring	<input type="checkbox"/> Personal sites and Blogs	<input type="checkbox"/> Sports
<input checked="" type="checkbox"/> Adult and Pornography	<input type="checkbox"/> Financial Services	<input type="checkbox"/> Kids	<input type="checkbox"/> Philosophy and Political Advocacy	<input checked="" type="checkbox"/> Spyware and Adware
<input type="checkbox"/> Alcohol and Tobacco	<input type="checkbox"/> Food and Dining	<input type="checkbox"/> Legal	<input checked="" type="checkbox"/> Phishing and Other Frauds	<input type="checkbox"/> Stock and Advice Tools
<input type="checkbox"/> Auctions	<input type="checkbox"/> Gambling	<input type="checkbox"/> Local Information	<input type="checkbox"/> Private IP Addresses	<input type="checkbox"/> Streaming Media
<input type="checkbox"/> Bot Nets	<input type="checkbox"/> Games	<input checked="" type="checkbox"/> Malware Sites	<input type="checkbox"/> Proxy Avoidance and	<input type="checkbox"/> Swimsuits & Intimate Apparel

Blacklist & Whitelist

Blacklist: * Domain Name **+ Add** **✕ Cancel** **🗑 Delete**

Domain Name

Whitelist: * Domain Name **+ Add** **✕ Cancel** **🗑 Delete**

Domain Name

Safe Search

Google Safe Search: **Enable**

YouTube Safe Search: **Enable**

Bing Safe Search: **Enable**

Configure the following:

- General Options
 - Name: type the name of the policy you want to create.

Services and Profiles

URL Filtering

Description: type a brief description for the policy to identify

- **Blocked Categories:** select one of the categories to block. Choosing the Custom option allows the administrator to customize the list of categories to block for the user. You can also use Select All to choose all of the categories listed, or None to set no filters for the user to access - user can access any URL in this case as no web page is blocked.
- **Blacklist and Whitelist:** If web content categorization is unable to classify URLs that the user, organization or institution needs, then Whitelist or Blacklist profiles can be created by the administrator. The URLs listed by the administrator under Blacklist are blocked and those listed under Whitelist are allowed access. The domain names under the Blacklist and Whitelist take precedence over the default allow or deny action of the URL filter.

The AP matches the URL pattern against all the configured Whitelist and Blacklists through the *egrep* (Extended Global Regular Expressions Print) program which performs a line-by-line scan of the file and returns lines that contain a pattern matching the given expression. Currently, the exact URL name or a wildcard at the beginning of the URL is used to match the pattern.

Administrators can also add specific IP addresses or wildcard domain names under Whitelist and Blacklist.

In **Domain Name**, type the domain name of the web page that you want to deny user access to in the **Blacklist** tab, and provide user access to in the **Whitelist** tab. You can define up to 16 domains.

Click **Add**. The domain name/web page is listed in the corresponding tab.

Click **Cancel** to remove the domain name you have entered in the field.

If you want to delete the domain name from the *Blacklist* or *Whitelist* tab, select the URL and click **Delete**.

- **Safe Search:** Administrators can configure the policy to include a safe search option when users access Google, YouTube or Bing to search on the internet. Select the **Enable** check box to set the safe search feature to ON. Enabling this option will mandate all users using this policy on the network to use safe search on Google, YouTube and Bing. This option provides a secure connection via HTTPS while still allowing access to the internet. Enabling safe search on the browser displays the virtual IP address of the browser.

3. Click **OK**.

The **URL Filtering Policy** form is submitted with the specified configuration settings.

You have created the URL filtering policy. The newly created policy is displayed on **Profiles** page.

If you click on the policy, it displays the following information:

- Name
- Managed By
- Description
- Filtering Level
- # of Blocked Categorize
- # of Blacklist
- #of Whitelist
- Last Modified By
- Last Modified On

Click **Configure** to edit the policy. Click **Clone** to create a duplicate of the policy, or to make modifications to the existing settings of the clone.

Click **Delete** to delete the policy from the URL Filtering Profile.

Enabling URL Filtering on the Controller

You can enable the URL filtering feature on the WLAN controller to block or allow access to specific web sites or web pages.

By configuring the controller, the administrator can create a wireless network SSID and allow or deny access to a category of websites for all users that join this SSID.

Follow these steps to enable URL filtering on the controller:

1. In the **Wireless LANs** page, from the System tree hierarchy, select the domain, zone or WLAN system for which you want to enable URL.
2. Click **Create**.

The **Wireless LANs** page appears.

3. In **Advance Options**, select the **Enabled** check-box against the **URL Filtering** option.

The **URL Filtering Profile** field appears. Select a profile from a list of existing URL filtering profiles displayed in the drop-down menu. You can also click **Create** to create a new URL filtering profile.

For more information, see [Creating a URL Filtering Policy](#) on page 198.

FIGURE 90 Enabling URL Filtering

Create WLAN Configuration

The screenshot shows the 'Create WLAN Configuration' interface. The 'Advanced Options' section is expanded, showing various configuration options. The 'URL Filtering' checkbox is checked and highlighted with a red box. The 'URL Filtering Profile' dropdown is set to 'Clone of fd'. Other options include 'User Traffic Profile' (System Default), 'L2 Access Control' (Disable), 'OS Policy' (Disable), 'Application Recognition & Control' (unchecked), 'Client Fingerprinting' (checked), 'Access VLAN' (VLAN ID 1), and 'Hide SSID' (unchecked).

NOTE

Application rules are applied based on the following priority, and user defined rules take precedence over URL filtering.

1. User defined ARC profile
2. URL Filtering
3. ARC

You have enabled URL filtering on the controller.

Enabling URL Filtering in the User Traffic Profile

A User Traffic Profile (UTP) can be created to block or limit user traffic based on a number of factors, including URL filtering in addition to Source IP address, Port, Destination IP address, Protocol, etc. A UTP can be created to shape traffic according to a configurable Application Control Policy.

After the UTP is created, it can be applied to any WLAN from the **Wireless LANs** page.

1. Go to **Services & Profiles > Access Control**.
2. Select the **User Traffic** tab, and then select the zone for which you want to create the profile.
3. Click **Create**.

The **Create User Traffic Profile** page appears.

4. In **URL Filtering Control**, select the **URL Filtering Profile** from the drop-down menu.

You can also create a URL filtering profile by clicking **Create**. For more information, refer to [Creating a URL Filtering Policy](#) on page 198.

NOTE

You must select a UTP in which URL filtering is enabled, and also ensure URL filtering is enabled within the same WLAN configuration.

FIGURE 91 UTP Page

Create User Traffic Profile

Default Access: Default access if no rule is matched: Allow Block

+ Create

Priority	Description	Matching Criteria	Access
1	Allow DNS	Destination Port:53 Direction:Upstream	Allow
2	Allow DHCP	Destination Port:67 Direction:Upstream	Allow

Application Recognition and Control

Application Policy: No data available

URL Filtering Control

URL Filtering Profile: No data available

You have successfully enable URL filtering in the UTP.

Managing URL Filtering Licenses

URL Filtering license for the selected partners-to use the content database is issued for a duration of one year for an AP. Dashboard warnings are issued thirty days before the end of the license term.

You can add licenses over time. For example, you can purchase 100 one-year licenses on January 1st and add another 200 one-year licenses in May. The controller receives a new expiry date for the combined license count of 300 APs.

To view license details such as start date, end date, and capacity, go to **Administration > Licenses > Installed Licenses** tab. For more information on importing installed licenses, synchronizing the controller with the license server, and downloading license files, refer *Managing Licenses*.

When the license capacity is exhausted, event code 1281 is triggered. When the license period expires, alarm code 8003 is generated which indicates that the URL filtering server is unreachable. For more information, refer *Managing Events and Alarms*.

Authentication

You can add AAA servers to the controller in order to use them to authenticate users attempting to associate with controller-managed APs.

Creating Non-Proxy Authentication AAA servers

A non-proxy AAA server is used when the APs connect to the external AAA server directly.

1. Go to **Services & Profiles > Authentication**.
2. Select the **Non-Proxy (AP Authenticator)** tab, and then select the zone for which you want to create the AAA server.

3. Click **Create**.
The **Create AAA Server** page appears.

FIGURE 92 Creating an AAA Server

Create AAA Server

General Options

* Name:

Description:

* Type: RADIUS Active Directory LDAP

Backup RADIUS: Enable Secondary Server

Primary Server

* IP Address:

* Port:

* Shared Secret:

OK **Cancel**

4. Configure the following:

1. General Options

- Name: Type a name for the AAA server that you are creating.
- Description: Type a short description of the AAA server.
- Type: Select the type of AAA server that you are creating. Options include RADIUS, Active Directory and LDAP.
- Backup RADIUS (appears if you clicked RADIUS above): Select the **Enable Secondary Server** check box if a secondary RADIUS server exists on the network.
- Global Catalog (appears if you clicked Active Directory above): Select the **Enable Global Catalog support** if you the Active Directory server to provide a global list of all objects.

2. Authentication Types

- If you selected RADIUS, configure the following options in the Primary Server section:
 - IP Address: Type the IP address of the AAA server. Both IPv4 and IPv6 addressing formats are supported.
 - Port: Type the port number of the AAA server. The default RADIUS server port number is 1812.
 - Shared Secret: Type the AAA shared secret.
 - Confirm Secret: Retype the shared secret to confirm.

If you have enabled **Backup RADIUS** to the **Secondary Server**, you must provide similar information as in the primary server.

See [RADIUS Service Options](#) on page 210 for more information.

- If you selected Active Directory, configure the following options in the Primary Server section:
 - IP Address: Type the IPv4 address of the AD server.
 - Port: Type the port number of the AD server. The default port number (389) should not be changed unless you have configured the AD server to use a different port.
 - Windows Domain Name: Type the Windows domain name assigned to the AD server (for example, domain.ruckuswireless.com).
- If you selected LDAP, configure the following options:
 - IP Address: Type the IPv4 address of the LDAP server.
 - Port: Type the port number of the LDAP server. Default is 389.
 - Base Domain Name: Type the base DN in LDAP format for all user accounts (for example, dc=ldap,dc=com).
 - Admin Domain Name: Type the admin DN in LDAP format (for example, cn=Admin;dc=<Your Domain>,dc=com).
 - Admin Password: Type the administrator password for the LDAP server.
 - Confirm Password: Retype the administrator password to confirm.
 - Key Attribute: Type a key attribute to denote users (for example, default: uid)
 - Search Filter: Type a search filter (for example, objectClass=Person).

5. Click **OK**.

You have completed creating a Non-proxy AAA server.

NOTE

You can also edit, clone and delete an AAA server by selecting the options **Configure**, **Clone** and **Delete** respectively, from the **Non-Proxy (AP Authenticator)** tab.

Testing AAA Server (Auth)

To ensure that the controller administrators will be able to authenticate successfully with the RADIUS server type that you selected, Ruckus Wireless strongly recommends testing the AAA server after you set it up.

The test queries the RADIUS server for a known authorized user and return groups associated with the user that can be used for configuring roles within the controller.

1. Go to **Services & Profiles > Authentication**.
2. Select the **Non-Proxy (AP Authenticator)** tab, and then select the zone for which you want to test the AAA server.
3. Click **Test AAA**.

The **Test AAA Server** page appears.

FIGURE 93 Testing an AAA Server

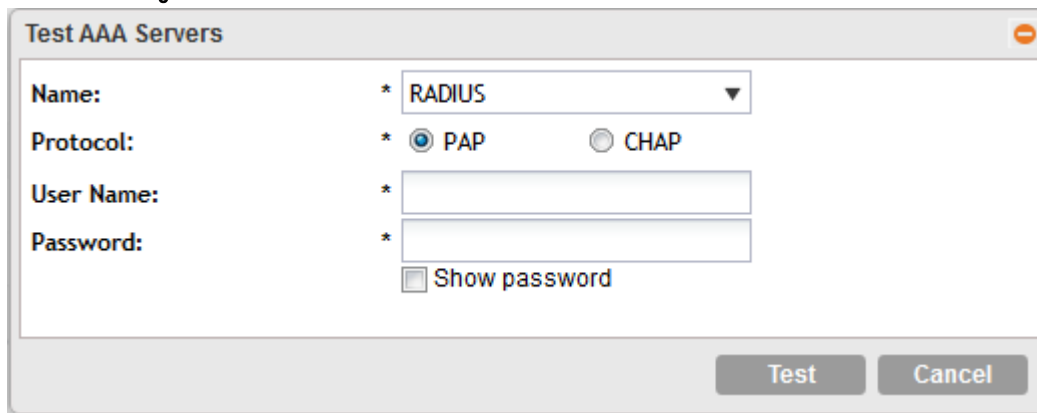

4. Configure the following:
 1. Name: Select one of the AAA servers that you previous created.
 2. Protocol: Select the Password Authentication Protocol (PAP), or the Challenge Handshake Authentication Protocol (CHAP) to authenticate the AAA server.
 3. User Name: Type an existing user name on the AAA server that you selected.
 4. Password: Type the password for the user name you specified.
5. Click **Test**.

If the test was unsuccessful, there are two possible results (other than success) that will be displayed to inform you if you have entered information incorrectly: **Admin invalid** or **User name or password invalid**. These results can be used to troubleshoot the reasons for failure to authenticate administrators with an AAA server through the controller.

You have completed testing the non-proxy AAA servers that you created.

Creating Proxy AAA Servers

A proxy AAA server is used when APs send authentication/accounting messages to the controller and the controller forwards these messages to an external AAA server.

1. Go to **Services & Profiles > Authentication**.
2. Select the **Proxy (SZ Authenticator)** tab, and then select the zone for which you want to create the AAA server.

3. Click **Create**.
The **Create Authentication Service** page appears.

FIGURE 94 Creating an Authentication Service

Create Authentication Service [X]

* Name:
Friendly Name:
Description:

* Service Protocol: RADIUS Active Directory LDAP

RADIUS Service Options

RFC 5580 Out of Band Location Delivery: Enable for Ruckus AP Only

Primary Server

* IP Address:
* Port:
* Shared Secret:
* Confirm Secret:

Secondary Server

OK Cancel

4. Configure the following:
 1. Name: Type a name for the authentication service that you are adding.
 2. Friendly Name: Type an alternative name that is easy to remember.
 3. Description: Type a description for the authentication service.
 4. Service Protocol: If you select
 - RADIUS, see [RADIUS Service Options](#) on page 210 for more information.
 - Active Directory, configure the following:
 1. Global Catalog: Select the **Enable Global Catalog** support if you the Active Directory server to provide a global list of all objects.
 2. Primary Server:
 - Encryption: Select the **Enable TLS Encryption** check box if you want to use the *Transport Layer Security* (TLS) protocol to secure communication with the server.

NOTE

You must also configure the Trusted CA certificates to support TLS encryption.

3. IP Address: Type the IPv4 address of the AD server.
4. Port: Type the port number of the AD server. The default port number (389) should not be changed unless you have configured the AD server to use a different port.
5. Windows Domain Name: Type the Windows domain name assigned to the AD server (for example, domain.ruckuswireless.com).
- LDAP, configure the following:
 1. Select the **Enable TLS Encryption** check box if you want to use the *Transport Layer Security* (TLS) protocol to secure communication with the server.

NOTE

You must also configure the Trusted CA certificates to support TLS encryption.

2. IP Address: Type the IPv4 address of the LDAP server.
3. Port: Type the port number of the LDAP server.
4. Base DN: Type the base DN in LDAP format for all user accounts (for example, dc=ldap,dc=com).
5. Admin DN: Type the admin DN in LDAP format (for example, cn=Admin;dc=<Your Domain>,dc=com).
6. Admin Password: Type the administrator password for the LDAP server.
7. Confirm Password: Retype the administrator password to confirm.
8. Key Attribute: Type a key attribute to denote users (for example, default: uid)
9. Search Filter: Type a search filter (for example, objectClass=Person).
- OAuth, configure the following:
 1. Provider: Authorize Google, Facebook or LinkedIn by selecting one of them.
 2. Application ID: Specify the application ID.
 3. Application Secret: Type the application secret.
 4. Collect E-mail Address: Select this check-box if you want the controller to collect the user's email address and maintain it for further use.
- HLR, configure the following:

1. General Settings
 - SGSN ISDN Address: Type any number from 1 to 9.
 - Routing Context: Type 1 to identify the application service process (ASP).
 - Local Point Code: Type the local point code number for the controller. Default is 1.
 - Default Point Code format: Select Integer format.
 - EAP-SIM Map Version: Select map version 3 from the drop-down menu.
 - Authorization Map Version: Select map version 3 from the drop-down menu.
2. SCCP Addresses Default Settings
 - Source GT Indicator: Select a GT indicator from the drop-down. You can select translation type only or in addition to numbering plan, encoding scheme and nature of address indicator.
 - Source Has Point Code: Select Yes or No.
 - Source Translation Type: Type the appropriate integer value.
 - Source Numbering Plan: Select ISDN/Recommended plan (E.163/E.164).
 - Source Nature Address of Indicator: Select from Subscriber Number, Reserved for National Use, National Significant Number and International Number (recommended).
 - Address Indicator: Select between Route on GT and SSN.
 - Destination GT Indicator: Select a GT indicator from the drop-down. You can select translation type only or in addition to numbering plan, encoding scheme and nature of address indicator.
 - Destination Translation Type: Type the appropriate integer value.
 - Destination Numbering Plan: Select ISDN/Recommended plan (E.163/E.164) or E.214.
 - Destination Nature Address of Indicator: Select from Subscriber Number, Reserved for National Use, National Significant Number and International Number.
 - GT Point Code: Set to 2.
3. SCTP Association to Core Network
 - Destination IP: Type the IP address of the destination port.
 - Destination Port: Type the number of the destination port.
 - Source Port: Type the number of the source port.
 - Max Inbound Streams: Set to 32.
 - Max Outbound Streams: Set to 32
 - Adjacent Point Code: Set to 2.
4. SCCP GTT Table
 - GT Digits: Type any number (1 to 15 digit number).
 - Address Indicator: Select between options to route on GT or SSN.
 - Point Code: Set to 1.
 - Translation Type: Type the appropriate integer value.
 - GT Indicator: Select a GT indicator from the drop-down. You can select translation type only or in addition to numbering plan, encoding scheme and nature of address indicator.
 - Has Point Code: Select between Yes and No.
 - Has SSN: Select between Yes and No.
 - Number Planning: Select ISDN/Recommended plan (E.163/E.164) or E.214.
 - Nature of Address Indicator: Select from Subscriber Number, Reserved for National Use, National Significant Number and International Number.

NOTE

Ensure that the settings provided in the **GTT table** are match the ones provided in the **SCCP Addresses Default Settings** section.

Services and Profiles

Authentication

5. Cache Options: select Enable AV Caching (makes use of the existing cache memory values).
5. Advanced Options - Domain name: Type the whitelisted domain name that you want to add.
6. User Traffic Profile Mapping:
 - a. Type a **Group Attribute Value**.
 - b. Select a **User Role** from the drop-down list.
 - c. Click **Add**.The mapped user profile is listed.
5. Click **OK**.

You have completed creating a Proxy AAA server.

NOTE

You can also edit, clone and delete an AAA server by selecting the options **Configure**, **Clone** and **Delete** respectively, from the **Proxy (SZ Authenticator)** tab.

RADIUS Service Options

These are the Radius service options available for the primary and secondary servers.

RFC 5580 Out of Band Location Delivery: If you want out-of-band location delivery (RFC 5580) to apply only to Ruckus Wireless APs, select the **Enable for Ruckus AP Only** check box.

Configure the primary RADIUS server settings as shown in the following table.

Configure the primary RADIUS server settings.

TABLE 22 Primary Server Options

Option	Description
IP Address	Type the IP address of the RADIUS server. IPv4 and IPv6 addressing formats are supported.
Port	Type the port number of the RADIUS server. The default RADIUS server port number is 1812 and the default RADIUS Accounting server port number is 1813.
Shared Secret	Type the RADIUS shared secret.
Confirm Secret	Retype the shared secret to confirm.

If you have a secondary RADIUS server on the network that you want to use as a backup, select the Enable Secondary Server check box, and then configure the settings in the following table.

TABLE 23 Secondary Server Options

Option	Description
Backup RADIUS	Select Enable Secondary Server . When a secondary RADIUS server is enabled and the primary RADIUS server becomes unavailable, the secondary Automatic Fallback Disable server takes over the handling of RADIUS requests. When the primary server becomes available again, it takes back control over RADIUS requests from the secondary server. If you want to prevent the primary server from retaking control over RADIUS requests from the secondary server, select the Automatic Fallback Disable check box.
IP Address	Type the IP address of the secondary AAA server.

TABLE 23 Secondary Server Options (continued)

Option	Description
Port	Type the port number of the secondary AAA server port number. The default RADIUS server port number is 1812 and the default RADIUS Accounting server port number is 1813.
Shared Secret	Type the AAA shared secret.
Confirm Secret	Retype the shared secret to confirm.

The following options define the health monitoring settings of the primary and secondary RADIUS servers, when the controller is configured as RADIUS proxy for RADIUS Authentication and Accounting messages.

TABLE 24 Health Check Policy

Option	Description
Response Window	<p>Set the time (in seconds) after which, if the AAA server does not respond to a request, the controller will initiate the zombie period (see below). Response Window If the primary AAA server does not respond to RADIUS messages sent after Response Window expires, the controller will forward the retransmitted RADIUS messages to the secondary AAA server.</p> <p>NOTE The zombie period is not started immediately after the Response Window expires, but after the configured Response Window plus $\frac{1}{4}$ of the configured Zombie Period. The default Response Window is 20 seconds</p>
Zombie Period	<p>Set the time (in seconds) after which, if the AAA server does not respond to ANY packets during the zombie period, it will be considered to inactive or unreachable. An AAA server that is marked zombie (inactive or unreachable) will be used to proxy with a low priority. If there are other live AAA servers, the controller will attempt to use these servers first instead of the zombie AAA server. The controller will only proxy requests to a zombie server only when there are no other live servers. Any request that is sent as a proxy to an AAA server will continue to be sent to that AAA server until the home server is marked inactive or unreachable. At that point, the request will fail over to another server, if a live AAA server is available. The default Zombie Period is 40 seconds.</p>
Revive Interval	Set the time (in seconds) after which, if no RADIUS messages are sent as proxy to the AAA server after it has been marked as inactive or unreachable, the controller will mark the AAA server as active again (and assume that it has become reachable again). The default Revive Interval is 120 seconds.
No Response Fail	Click Yes to respond with a reject message to the NAS if no response is received from the RADIUS server. Click No to skip sending a response.

NOTE

To ensure that the RADIUS fail-over mechanism functions correctly, either accept the default values for the Response Window, Zombie Period, and Revive Interval, or make sure that the value for Response Window is always higher than the value for RADIUS NAS request timeout multiplied by the value for RADIUS NAS max number of retries. For third party APs, you must ensure that the configured Response Window on the controller is higher than the RADIUS NAS request timeout multiplied by the RADIUS value. The maximum number of retries is configured at the 3rd party controller/AP.

Services and Profiles

Authentication

Configure the following options.

TABLE 25 Rate Limiting

Options	Description
Maximum Outstanding Requests (MOR)	Set the maximum outstanding requests per server. Type 0 to disable it, or set a value between 10 and 4096.
Threshold (% of MOR)	Set a percentage value of the MOR at which (when reached) the controller will generate an event. Threshold (% of MOR) For example, if the MOR is set to 1000 and the threshold is set to 50%, the controller will generate an event when the number of outstanding requests reaches 500.
Sanity Timer	Set a timer (in seconds) that will be started whenever a condition that generates an event is reached. This helps prevent conditions that trigger events which occur frequently.

Testing AAA Servers

To ensure that the controller administrators will be able to authenticate successfully with the RADIUS server type that you selected, Ruckus Wireless strongly recommends testing the AAA server after you set it up.

1. Go to **Services & Profiles > Authentication**.
2. Select the **Proxy (SZ Authenticator)** tab, and then select the zone for which you want to test the AAA server.

3. Click **Test AAA**.
The **Test AAA Server** page appears.

FIGURE 95 Testing an AAA Server

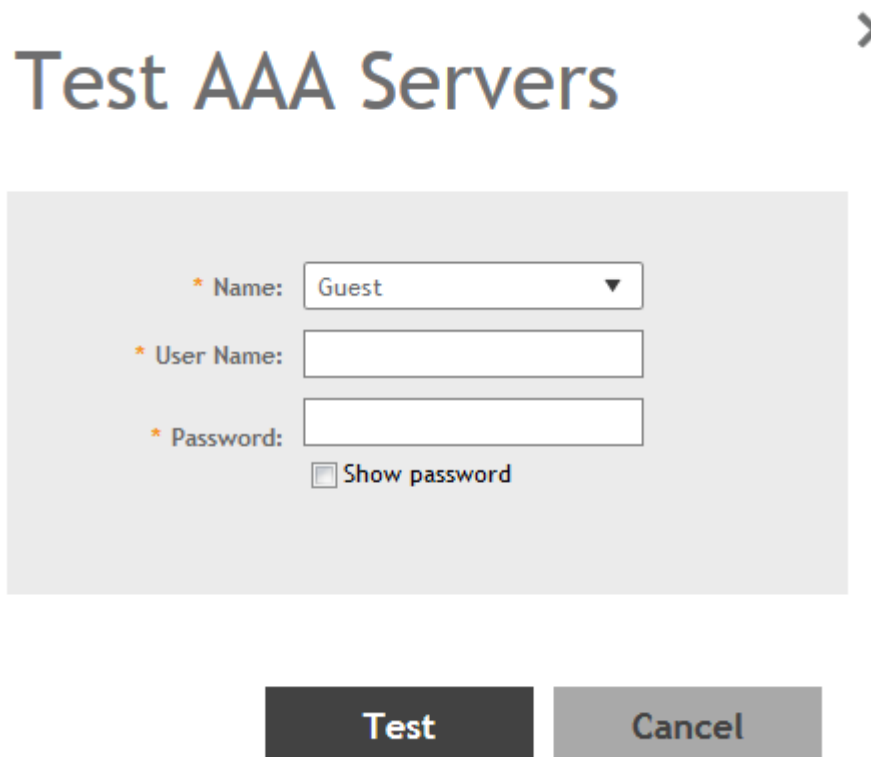

The screenshot shows the 'Test AAA Servers' interface. It features a title 'Test AAA Servers' with a right-pointing arrow. Below the title is a form with three fields: '* Name:' with a dropdown menu showing 'Guest', '* User Name:' with an empty text box, and '* Password:' with an empty text box and a 'Show password' checkbox. At the bottom are two buttons: 'Test' (dark grey) and 'Cancel' (light grey).

4. Configure the following:
 1. Name: Select one of the AAA servers that you previously created.
 2. User Name: Type an existing user name on the AAA server that you selected.
 3. Password: Type the password for the user name you specified.
5. Click **Test**.

If the controller was able to connect to the authentication server and retrieve the configured groups/attributes, the information appears at the bottom of the page. If the test was unsuccessful, there are two possible results (other than success) that will be displayed to inform you if you have entered information incorrectly: **Admin invalid** or **User name or password invalid**. These results can be used to troubleshoot the reasons for failure to authenticate administrators with an AAA server through the controller.

Creating Realm Based Authentication Profile

An authentication profile defines the authentication policy when the controller is used as a Radius proxy service for WLANs.

1. Go to **Services & Profiles > Authentication**.
2. Select the **Realm Based Proxy** tab, and then select the zone for which you want to create the profile.

3. Click **Create**.
The **Create Authentication Profile** page appears.

FIGURE 96 Creating a Realm Based Proxy Authentication Profile

Create Authentication Profile

Realm	Protocol	Auth Service	Auth Method	Dynamic VLAN ID
No Match	NA	NA-Disabled	Non-3GPP Call Flow	N/A

4. Configure the following:
 1. Name: Type a name for the authentication service profile that you are creating.
 2. Description: Type a short description of the authentication service profile.
 3. To enable hosted AAA support, select the **Enable Hosted AAA Support** check box, and then configure these options:
 - a. Interim Accounting Interval (secs): Set the interim time interval for RADIUS clients to send accounting updates. Default is 0, which indicates that the accounting interval is disabled.
 - b. Sessions Timeout (secs): Set a time limit after which users will be disconnected and required to log on again.
 - c. Session Idle Timeout (secs): Set a value in seconds (60 to 600) after which idle clients will be disconnected.
 4. Select the **Configure PLMN Identifier** check-box, and set the following options:
 - a. Mobile Country Code: Set the correct country code for the geographical location. This is required when the controller sends MAP authentication information to the HLR.
 - b. Mobile Network Code: Set the mobile network code based on the geographical location. This is required when the controller sends MAP authentication information to HLR.
 5. Realm-Based Authentication Service
 - Realm: Type where the realm is No Match or Unspecified.
 - Auth Service: Select a default authentication service for the realm.
 - Auth Method: Select an authorization method as 3GPP or Non-3GPP call flow.
 - Dynamic VLAN ID: Type the vlan ID.
 6. Redirection: select where to redirect the user after successfully completing authentication.
 - Redirect to the URL that the user intends to visit: Allows the guest user to continue to their destination without redirection.
 - Redirect to the following URL: Redirect the user to a specified web page (entered into the text box) prior to forwarding them to their destination. When guest users land on this page, they are shown the expiration time for their guest pass.
5. Click **OK**.

Accounting

Creating Non-Proxy Accounting AAA Servers

A non proxy AAA server is used when the APs connect to the external AAA server directly.

1. Go to **Services & Profiles > Accounting**.
2. Select the **Non-Proxy** tab, and then select the zone for which you want to create the AAA server.
3. Click **Create**.

The **Create AAA Server** page appears.

FIGURE 97 Creating an AAA Server

Create AAA Server

General Options

* Name:

Description:

* Type: RADIUS Active Directory LDAP

Backup RADIUS: Enable Secondary Server

Primary Server

* IP Address:

* Port:

* Shared Secret:

OK Cancel

4. Configure the following:
 1. General Options
 - Name: Type a name for the AAA server that you are creating.
 - Description: Type a short description of the AAA server.
 - Type: Select **RADIUS Accounting**.
 - Backup RADIUS (appears if you clicked RADIUS above): Select the **Enable Secondary Server** check box if a secondary RADIUS server exists on the network.
 2. If you selected RADIUS, configure the following options in the Primary and Secondary server sections:
 - IP Address: Type the IP address of the AAA server.
 - Port: Type the port number of the AAA server. The default RADIUS server port number is 1813.
 - Shared Secret: Type the AAA shared secret.
 - Confirm Secret: Retype the shared secret to confirm.
5. Click **OK**.

You have completed creating a Non-proxy Accounting AAA server.

For information on how to test this server, see [Testing AAA Servers](#) on page 212

NOTE

You can also edit, clone and delete an AAA server by selecting the options **Configure**, **Clone** and **Delete** respectively, from the **Non-Proxy** tab.

Creating Proxy Accounting AAA Servers

A proxy AAA server is used when APs send authentication/accounting messages to the controller and the controller forwards these messages to an external AAA server.

1. Go to **Services & Profiles > Accounting**.
2. Select the **Proxy** tab, and then select the zone for which you want to create the AAA server.

3. Click **Create**.
The **Create Accounting Service** page appears.

FIGURE 98 Creating an Accounting Service

4. Configure the following:
 1. **Name:** Type a name for the authentication service that you are adding.
 2. **Description:** Type a description for the authentication service.
 3. **Service Protocol:** By default, the RADIUS Accounting selected. For more information, see [RADIUS Service Options](#) on page 210.
5. Click **OK**.

You have completed creating a Proxy Accounting AAA server.

For information on how to test this server, see [Testing AAA Servers](#) on page 212

NOTE

You can also edit, clone and delete an AAA server by selecting the options **Configure**, **Clone** and **Delete** respectively, from the **Proxy** tab.

Creating Realm Based Proxy

An accounting profile defines the accounting policy when the controller is used as a RADIUS proxy for WLAN services.

1. Go to **Services & Profiles > Accounting**.
2. Select the **Realm Based Proxy** tab, and then select the zone for which you want to create the AAA server.

3. Click **Create**.
The **Create Accounting Profile** page appears.

FIGURE 99 Creating an Accounting Profile

Create Accounting Profile

The screenshot shows the 'Create Accounting Profile' configuration page. It features the following elements:

- Input fields for 'Name' and 'Description'.
- A dropdown menu for 'Accounting Service Per Realm'.
- A table with columns 'Realm' and 'Accounting Service'. The table contains two rows: 'No Match' and 'Unspecified', both with 'NA-Disabled' in the 'Accounting Service' column.
- Buttons for '+ Add', 'Cancel', and 'Delete' next to the table.
- 'OK' and 'Cancel' buttons at the bottom right.

4. Configure the following:
 1. Name: Type a name for the authentication service that you are adding.
 2. Description: Type a description for the authentication service.
 3. Accounting Service per Realm: Specify the accounting service for each of the realms specified in this table. If you set the accounting service for a particular realm to NA-Disabled, then the accounting request is rejected. To create a new service click, **Create** and then configure **Realm** and **Accounting Service**.
5. Click **OK**.

You have completed creating a Realm-based proxy Accounting AAA server.

NOTE

You can also edit, clone and delete an AAA server by selecting the options **Configure**, **Clone** and **Delete** respectively, from the **Realm Based Proxy** tab.

Classifying Rogue Policy

You can create rogue classification policy with rules at the zone-level. This helps in automatic classification behavior when a specific-rogue detection criteria are met.

To create a rogue classification policy:

1. Go to **Services & Profiles > WIPS**.
2. In the **Policy** tab, select the zone for which you want to create the policy.
3. Click **Create**.

The Create Rogue Classification Policy page appears.

4. Configure the following:
 - a) **Name** : Type a name for the policy.
 - b) **Description** : Type a description for the policy.
 - c) **Rogue Classification Rules** : Create the policy rule by configuring the following :
 - Click **Create**. The Create Rogue Classification Rules page appears.
 - Configure the following options:
 - **Name**: Enter a name for the rule.
 - **Rule Type**: Select one of following the rule type for the Classification:
 - > Low RSSI
 - > MAC OUI
 - > MAC Spoofing
 - > Same Network
 - > SSID
 - > SSID Spoofing
 - **Signal Threshold**: Enter the RSSI threshold in dBm. This option is available only for **Low RSSI** rule type.
 - **MAC OUI**: Enter the first three octets of the MAC. For example, 11:22:33. This option is available only for **MAC OUI** rule type.
 - **SSID**: Enter the SSID. This option is available only for **SSID** rule type.
 - **Classification**: Select one of the following action for the selected **Rule Type**:
 - > Ignore
 - > Know
 - > Malicious
 - > Rogue
 - Click **OK**. You have created a Rogue classification rule.
5. Click **OK**.

You have created Rogue classification policy.

NOTE

You can also edit or delete a Rogue classification policy. To do so, select the rogue classification from the list and click **Configure** or **Delete** as required.

NOTE

To prioritize the classification rule, select the rule from the list and click **UP** or **Down** to position the rule.

Bonjour

Bonjour is Apple's implementation of a zero-configuration networking protocol for Apple devices over IP.

Bonjour allows OS X and iOS devices to locate other devices such as printers, file servers and other clients on the same broadcast domain and use the services offered without any network configuration required.

Multicast applications such as Bonjour require special consideration when being deployed over wireless networks. Bonjour only works within a single broadcast domain, which is usually a small area. This is by design to prevent flooding a large network with multicast traffic. However, in some situations, a user may want to offer Bonjour services from one VLAN to another.

Services and Profiles

Bonjour

SmartZone provides two features for controlling how and where Bonjour services are available to clients:

- [Bonjour Gateway](#) on page 220: Bridge Bonjour services from one VLAN to another.
- [Bonjour Fencing](#) on page 222: Limit the range in physical space at which Bonjour services are available to clients.

Bonjour Gateway

Bonjour Gateway policies enable APs to provide Bonjour services across VLANs.

The controller's Bonjour gateway feature provides an mDNS proxy service configurable from the web interface to allow administrators to specify which types of Bonjour services can be accessed from/to which VLANs.

In order for the Bonjour Gateway to function, the following network configuration requirements must be met:

- The target networks must be segmented into VLANs.
- VLANs must be mapped to different SSIDs.
- The controller must be connected to a VLAN trunk port.

Additionally, if the VLANs to be bridged by the gateway are on separate subnets, the network has to be configured to route traffic between them.

The following requirements and limitations should be taken into consideration before enabling the Bonjour Gateway feature:

- Bonjour policy deployment to an AP takes effect after the AP joins the controller.
- Some APs of one local area link must be in one subnet. The switch interfaces connected to these APs must be configured in VLAN-trunk mode. Only by doing so can the designated AP receive all the multicast Bonjour protocol packets from other VLANs.
- Dynamic VLANs are not supported.
- Some AP models are incompatible with this feature due to memory requirements.

Creating Bonjour Gateway Policies

A Bonjour Gateway policy must be created for an AP zone before the policy can be deployed to an AP or group of APs.

To create a Bonjour Gateway policy:

1. Go to **Services & Profiles > Bonjour**.
2. Select the **Gateway** tab, and then select the zone for which you want to create the policy.

3. Click **Create**.
The **Create Bonjour Policy** page appears.

FIGURE 100 Creating a Bonjour Gateway Policy

Create Bonjour Policy

The screenshot shows the 'Create Bonjour Policy' configuration page. It features a form with the following elements:

- Name:** A text input field with an asterisk indicating it is required.
- Description:** A text input field.
- Rules:** A dropdown menu currently showing 'Rules'.
- Actions:** A row of buttons: '+ Create', 'Configure' (with a pencil icon), 'Delete' (with a trash icon), 'Up' (with an up arrow icon), and 'Down' (with a down arrow icon).
- Table:** A table with the following columns: 'Priority', 'Bridge Service', 'From VLAN', 'To VLAN', and 'Notes'. The table is currently empty.
- Buttons:** 'OK' and 'Cancel' buttons located at the bottom right of the form.

4. Configure the following:
 1. **Name:** Type a name for the policy.
 2. **Description:** Type a description for the policy.
 3. **Rules:** Create the policy rule by configuring the following
 - a. Click **Create**. The **Create Bonjour Policy Rule** page appears.
 - b. Configure the following options:
 - **Bridge Service:** Select the Bonjour service from the list.
 - **From VLAN:** Select the VLAN from which the Bonjour service will be advertised.
 - **To VLAN:** Select the VLAN to which the service should be made available.
 - **Notes:** Add optional notes for this rule.
 - c. Click **OK**.
You have created a Bonjour policy rule.
 4. Click **OK**.

You have created a Bonjour policy with a rule.

NOTE

You can also edit, clone and delete the policy by selecting the options **Configure**, **Clone** and **Delete** respectively, from the **Gateway** tab.

You may now continue to apply this Bonjour gateway policy to an AP or AP group, as described in [Applying a Bonjour Gateway Policy to an AP or AP Group](#) on page 222.

Applying a Bonjour Gateway Policy to an AP or AP Group

Once a Bonjour Gateway policy is created, you can select which AP (or AP group) will serve as the gateway for Bonjour services.

To apply a Bonjour Gateway policy to an AP or AP group:

1. Go to **Access Points > Access Points**.
2. Select the AP or AP group that you want to configure from the zone in which the AP/group exists.
3. Click **Configure**.
4. Expand the **Advanced Options**, and in **Bonjour Gateway**, enable the check box next to **Enable as Bonjour Gateway with policy**, and select the policy you created from the drop-down list.
5. Click **OK** to save your changes.

Bonjour Fencing

Bonjour Fencing provides a mechanism to limit the scope of Bonjour (mDNS) service discovery in the physical/spatial domain.

While Bonjour Fencing is related to Bonjour Gateway, they are two separate features designed for different purposes. Bonjour Gateway bridges mDNS services across VLANs, and is useful because Bonjour is designed as a same-VLAN protocol. Bonjour Fencing limits the range of Bonjour service discovery within physical space, which is useful because logical network boundaries (e.g. VLANs) do not always correlate well to physical boundaries within a building/floor.

The following considerations should be taken into account before deploying Bonjour fencing policies:

- Bonjour fencing is not supported on Mesh APs.
- Switch interfaces to which APs are connected must be configured in VLAN trunk mode so that Bonjour traffic gets forwarded across VLANs based on Bonjour Gateway Policies.
- Bonjour fencing is implemented at the AP, not at the controller.
- Fencing policies can be applied on a zone level only, and cannot be configured per AP group.
- In order for a wired fencing policy to work properly, wireless fencing for the same mDNS service should also be enabled. If wired fencing is enabled but wireless is disabled, APs that are not the "closest AP" will be unable to determine whether the source of the mDNS advertisement was wired or wireless.
- Bonjour fencing will work for local breakout scenarios, but will not work for tunnel based configuration. (This feature is supported only for SZ300 controllers)

Creating Bonjour Fencing Policies

Bonjour Fencing policies can be created and applied to a zone at the same time using the Fencing tab on the **Services and Profiles > Bonjour** screen.

To create a Bonjour Fencing policy:

1. Go to **Services & Profiles > Bonjour**.
2. Select the **Fencing** tab, and then select the zone for which you want to create the policy.

3. Click **Create**.
The **Create Bonjour Fencing Policy** page appears.

FIGURE 101 Creating a Bonjour Fencing Policy

Create Bonjour Fencing Policy

* Name:

Description:

Fencing Rule

Device Type	Device MAC	Closest AP	Service	Fencing Range	Description

4. Configure the following:
 1. **Name:** Type a name for the policy.
 2. **Description:** Type a description for the policy.
 3. **Fencing Rule:** Create the policy rule by configuring the following:

FIGURE 102 Fencing Rule

The screenshot shows a 'Fencing Rule' configuration window. It includes the following elements:

- Device Type:** A dropdown menu set to 'Wired'.
- Closest AP:** A dropdown menu set to 'No data available'.
- Service:** A dropdown menu set to 'No data available'.
- Fencing Range:** A dropdown menu set to 'Same AP'.
- Description:** An empty text input field.
- Device MAC:** An empty text input field.
- MAC List:** A table with one header row labeled 'MAC' and one empty data row below it.
- Buttons:** '+ Add', 'x Cancel', and 'Delete' buttons are located to the right of the 'Device MAC' field. 'OK' and 'Cancel' buttons are at the bottom of the dialog.

- a. Click **Create**. The **Fencing Rule** page appears.
- b. Configure the following options:
 - **Device Type:** Select the Wireless or Wired network connection method for the device advertising Bonjour services.
 - **Closest AP:** Select the closest AP to create a physical anchor point for fencing, and the closest AP is auto-detected for wireless devices, based on the AP association.
 - **Service:** Select one of the Bonjour services from the drop-down list.
 - **Fencing Range:** Select the fencing range to be the Same AP or 1-Hop AP Neighbors.
 - **Description:** Specify any notes you may need to refer.
 - **Device MAC:** Specify the MAC address of the device advertising Bonjour services. This option is available only for Wired Device Type. It supports up to four wired MAC addresses.
- c. Click **OK** to save the rule.

You have created a Bonjour fencing rule. Each policy can contain up to 32 rules.

4. Click **OK** to save the policy.

You have created a Bonjour fencing policy.

NOTE

You can also edit, clone and delete the policy by selecting the options **Configure**, **Clone** and **Delete** respectively, from the **Fencing** tab.

Working with Tunnels and Ports

Creating a Ruckus GRE Profile

You can configure the Ruckus GRE tunnel profile of the controller to manage AP traffic.

1. Go to **Services & Profiles > Tunnels and Ports**.
2. Select the **Ruckus GRE** tab, and then select the zone for which you want to create the profile.
3. Click **Create**.

The **Create Ruckus GRE Profile** page appears.

FIGURE 103 Creating a Ruckus GRE Profile

Create Ruckus GRE Profile

* Name:

Description:

Ruckus Tunnel Mode: Support for APs behind NAT.

Tunnel Encryption: Enable tunnel encryption

* WAN Interface MTU: Auto Manual bytes (850-1500)

OK **Cancel**

Services and Profiles

Working with Tunnels and Ports

4. Configure the following:
 1. Name: Type a name for the profile.
 2. Description: Type a description for the profile.
 3. Ruckus Tunnel Model: Select a protocol to use for tunneling WLAN traffic back to the controller.
 - GRE + UDP: Select this option to allow APs behind a NAT server to tunnel WLAN traffic back to the controller.
 - GRE: Select this option to tunnel regular WLAN traffic only.
 4. Tunnel Encryption: Select the **Enable tunnel encryption** check box if you want managed APs to decrypt 802.11 packets, and then use an AES encrypted tunnel to send them to the controller. By default, when WLAN traffic is tunneled to the controller, only the management traffic is encrypted; data traffic is unencrypted.
 5. WAN Interface MTU: Set the maximum transmission unit (MTU) for the tunnel to either Auto (default) or Manual (a specific size 850 to 1500 bytes). MTU is the size of the largest protocol data unit that can be passed on the controller network.
 6. Click **OK**.

You have created the Ruckus GRE profile.

NOTE

You can also edit, clone and delete the profile by selecting the options **Configure**, **Clone** and **Delete** respectively, from the **Ruckus GRE** tab.

Creating a Soft GRE Profile

You can configure the Soft GRE tunnel profile of the controller to manage AP traffic.

1. Go to **Services & Profiles > Tunnels and Ports**.
2. Select the **Soft GRE** tab, and then select the zone for which you want to create the profile.

3. Click **Create**.
The **Create Soft GRE Profile** page appears.

FIGURE 104 Creating a Soft GRE Profile

Create SoftGRE Profile

* Name:

Description:

Gateway IP Mode: IPv4 IPv6

* Primary Gateway Address:

Secondary Gateway Address:

* Gateway Path MTU: Auto Manual bytes (IPv4:850-1500,IPv6:1384-1500)

* ICMP Keep Alive Period (secs): (1-180)

* ICMP Keep Alive Retry: (2-20)

OK **Cancel**

4. Configure the following:
 1. Name: Type a name for the profile.
 2. Description: Type a description for the profile.
 3. Gateway IP Mode: Select IPv4 or IPv6 addressing.
 4. Primary Gateway Address: Type the IP address or fully-qualified domain name (FQDN) of the primary gateway server.
 5. Secondary Gateway Address: If you have a secondary gateway server on the network, type its IP address or FQDN in the box provided. If the controller is unable to reach the primary gateway server, it will automatically attempt to reach the secondary gateway address that you specify here.
 6. Gateway Path MTU: Set the maximum transmission unit (MTU) for the gateway path. Options include Auto (default) and Manual (range is 850 to 1500 bytes).
 7. ICMP Keep Alive Period: Type the time interval (in seconds) at which APs send a keepalive message to the active third party WLAN gateway. The range is 1 to 180 seconds and the default value is 10 seconds.
 8. ICMP Keep Alive Retry: Type the number of keepalive attempts that APs wait for a response from the active third party WLAN gateway before failing over to the standby WLAN gateway. The range is 2 to 10 retries and the default value is 5 retries.
 9. Force Disassociate Client: Enable this option by selecting the check-box if you want to disassociate the client when AP fails over to another tunnel.
10. Click **OK**.

You have created the Soft GRE profile.

NOTE

You can also edit, clone and delete the profile by selecting the options **Configure**, **Clone** and **Delete** respectively, from the **Soft GRE** tab.

Creating an IPsec Profile

1. Go to **Services & Profiles > Tunnels and Ports**.
2. Select the **IPsec** tab, and then select the zone for which you want to create the profile.
3. Click **Create**.

The **Create IPsec Profile** page appears.

FIGURE 105 Creating an IPsec Profile

Create IPsec profile

The screenshot shows a dialog box titled "Create IPsec profile". The dialog is divided into three main sections, each with a header and a right-pointing arrow:

- General Options**: This section contains three input fields:
 - Name:** (marked with an asterisk)
 - Description:**
 - Security Gateway:**
- Authentication**: This section contains a right-pointing arrow.
- Security Association**: This section contains a right-pointing arrow.

At the bottom of the dialog, there are two buttons: **OK** and **Cancel**.

4. Configure the following:
 1. Name: Type a name for the profile.
 2. Description: Type a description for the profile.
 3. Security Gateway: Type the IP address or FQDN of the IPSec server. If you use the IP address, the IP address format that you must enter will depend on the IP mode that is configured on the controller.
 4. IP Mode: Select IPv4 or IPv6 addressing modes.

NOTE

This option is only applicable to SZ300.

5. Authentication: Select Preshared Key to use PSK for authentication or Certificate to use an X.509 certificate on the certificate authority (CA) or registration authority (RA) server. The controller uses the CMPv2 protocol to obtain the signed certificate from the CA/RA server.

If you selected Preshared Key, type the PSK in this box. The PSK must be eight to 128 ASCII characters in length.

6. Security Association
 - a. IKE Proposal Type: Select Default to use the default Internet Key Exchange (IKE) security association (SA) proposal type or select Specific to manually configure the IKE SA proposal. If you clicked Specific, you will need to configure the following settings:
 - Encryption Algorithm: Options include 3DES, AES128, AES192, and AES256.
 - Integrity Algorithm: Options include MD5, SHA1, AES-XCBC, SHA256, SHA384, and SHA512.
 - Pseudo-Random Function: Options include Use integrity ALG, PRF-MD5, PRF-SHA1, PRF-AES-XCBC, PRF-AES-CMAC, PRF-SHA256, and PRF-SHA384.
 - DH Group: Options for Diffie-Hellman groups for IKE include modp768, modp1024, modp1536, modp2048, modp3072, modp4096, modp6144, and modp8192.
 - b. ESP Proposal Type: Click Default to use the default Encapsulating Security Payload (ESP) SA proposal type or click Specific to manually configure the ESP proposal. If you clicked Specific, you will need to configure the following settings:
 - Encryption Algorithm: Options include 3DES, AES128, AES192, AES256, and NONE.
 - Integrity Algorithm: Options include MD5, SHA1, AES-XCBC, SHA256, SHA384, and SHA512.
 - DH Group: Options for Diffie-Hellman groups for ESP include None, modp768, modp1024, modp1536, modp2048, modp3072, modp4096, modp6144, and modp8192.
7. Rekey Options
 - a. Internet Key Exchange: To set time interval at which the IKE key renews, select a time unit (day, hour, or minute) from the drop-down list, and then type a number in the box. To disable IKE rekey, select the Disable check box. SmartZone 100/ Virtual SmartZone Essentials for Release 3.4 Administrator Guide 82 Configuring the Wireless Network Configuring Access Points.
 - b. Encapsulating Security Payload: To set time interval at which the ESP key renews, select a time unit (day, hour, or minute) from the drop-down list, and then type a number in the box. To disable ESP rekey, select the Disable check box.
8. Certificate Management Protocol
 - a. DHCP Option 43 Sub Code for CA/RA Address: Set the DHCP Option 43 subcode that will be used to discover the address of the CA/RA server on the network. The default subcode is 8.
 - b. CA/RA Address: Type the IP address or FQDN of the CA/RA server. If you use the IP address, the IP address format that you must enter will depend on the IP mode that is configured on the controller.
 - c. Server Path: Type the path to the X.509 certificate on the CA/RA server.

Services and Profiles

Working with Tunnels and Ports

- d. DHCP Option 43 Sub Code for Subject Name of CA/RA: Set the DHCP Option 43 subcode that will be used to discover the subject name of the CA/RA server on the network. The default subcode is 5.
 - e. Subject Name of CA/RA: Type an ASCII string that represents the subject name of the CA/RA server.
9. Advanced Options
- a. DHCP Option 43 Sub Code for Security Gateway: Set the DHCP Option 43 subcode that will be used to discover the address of the security gateway on the network. The default subcode is 7.
 - b. Retry Limit: Set the number of times that the controller will attempt to discover the address of the security gateway. The default retry count is 5. Accepted values are 0 (disable) to 16.
 - c. Replay Window: Set the ESP replay window (in packets). The default size is 32 packets. Accepted values are 0 (disable) to 32 packets.
 - d. IP Compression: To enable IP Payload Compression Protocol (IPComp) compression before encryption, click Enable. The default value is Disable.
 - e. Force NAT-T: To enforce UDP encapsulation of ESP packets, click Enable. The default value is Disable.
 - f. Dead Peer Detection: By default, the IKE protocol runs a health check with remote peer to ensure that it is alive. To disable this health check, click Disable.
 - g. NAT-T Keep Alive Interval: To set the keep alive interval (in seconds) for NAT traversal, type a value in the box. The default keep alive interval is 20 seconds. Accepted values are 1 to 65536. To disable the keep alive interval, click Disable.
 - h. FailOver Options: To configure the failover settings when APs are unable to connect, configure the following:
 - i. Retry Period: Set the number of days (minimum 3 days) during which APs will keep attempting to connect. To keep try indefinitely, select the **Forever** check box.
 - j. Retry Interval: Set the interval (in minutes) between each retry attempt. The default retry interval is 1 minute. Accepted values are from 1 to 30 minutes.
 - k. Retry Mode: If you want APs to fall back to the specified primary security gateway, click Revertive. If you want APs to maintain connectivity with the security gateway to which they are currently connected, click **Non-revertive**.
10. Click **OK**.

You have created the IPsec GRE profile.

NOTE

You can also edit, clone and delete the profile by selecting the options **Configure**, **Clone** and **Delete** respectively, from the **IPsec GRE** tab.

Creating an Ethernet Port Profile

An Ethernet port profile contains settings that define how an AP will handle VLAN packets when its port is designated as either trunk, access, or general port. By default, three Ethernet port profiles exist: General Port, Access Port and Trunk Port. In 3.6 SCG200-C is supported. SCG200-C is the SCG200 model without the internal DP functions. If Ruckus GRE tunnel is enabled, upgrade to SCG200-C is blocked and the following message appears: There exists an EthernetPortProfile [PROFILE_NAME] with RuckusGRE tunnel is applied

1. Go to **Services & Profiles > Tunnels and Ports**.
2. Select the **Ethernet Port** tab, and then select the zone for which you want to create the profile.

3. Click **Create**.
The Create Ethernet Port page appears.

FIGURE 106 Creating a Ethernet Port Profile

Create Ethernet Port

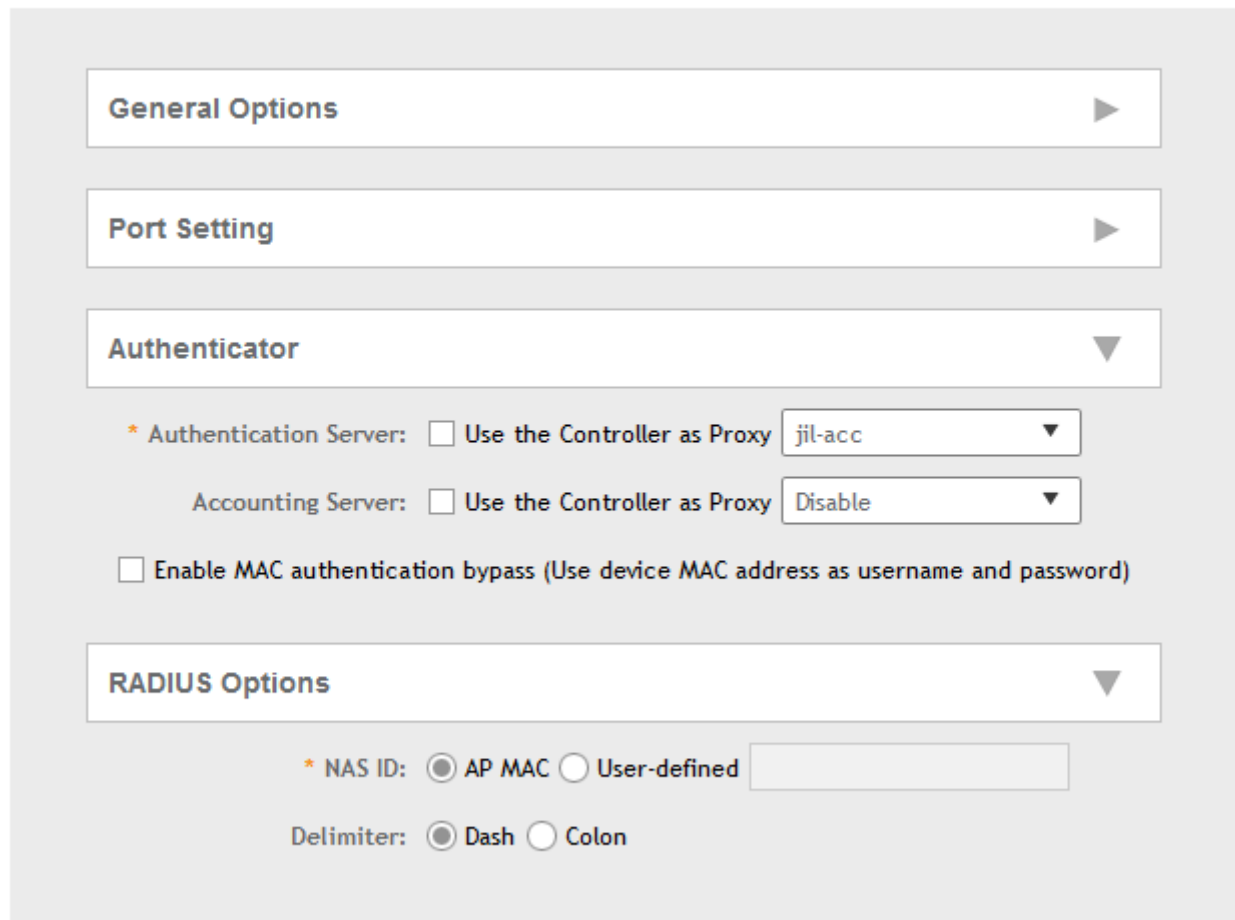

General Options ▶

Port Setting ▶

Authenticator ▼

* Authentication Server: Use the Controller as Proxy ▼

Accounting Server: Use the Controller as Proxy ▼

Enable MAC authentication bypass (Use device MAC address as username and password)

RADIUS Options ▼

* NAS ID: AP MAC User-defined

Delimiter: Dash Colon

4. Configure the following:

1. General Options

- a. Name: Type a name for the Ethernet port profile that you are creating.
- b. Description: Type a short description about the profile.
- c. Type: The Ethernet port type defines how the AP will manage VLAN frames. You can set Ethernet ports on an AP to one of the following types: Trunk Port, Access Port or General Port.

By selecting the appropriate port type, authentication method, and 802.1X Role, administrator can configure the ethernet ports to be used for the wired client. Up to 16 devices can be configured to connect to one ethernet port. After configuring the ports, the wired clients and their stats are displayed in the **Clients > Wired Clients** page. You can also delete a wired client from this page.

2. Ethernet Port Usage

- a. Access Network: Select this check box to enable tunneling on the Ethernet port.
- b. VLAN Untag ID: Type the ID of the native VLAN (typically, 1), which is the VLAN into which untagged ingress packets are placed upon arrival. If your network uses a different VLAN as the native VLAN, configure the AP Trunk port's VLAN Untag ID with the native VLAN used throughout your network.
- c. VLAN Members: Type the VLAN IDs that you want to use to tag WLAN traffic that will use this profile. You can type a single VLAN ID or a VLAN ID range (or a combination of both). The valid VLAN ID range is 1 to 4094.
- d. Enable Dynamic VLAN: Select this check box if you want the controller to assign VLAN IDs on a per-user basis. Before enabling dynamic VLAN, you need to define on the RADIUS server the VLAN IDs that you want to assign to users.

NOTE

This option is only available when Type is set to Access Port and 802.1X authentication is set to MAC-based Authenticator.

3. Guest VLAN: If you want to assign a device that fails authentication to still be able to access the Internet but to internal network resources, select this check box.

NOTE

This check box only appear when the Enable Dynamic VLAN check box is selected.

4. Authentication Options

- a. 802.1X: Select this check box to enable 802.1X authentication.
- b. Enable client visibility regardless of 802.1X authentication: select this check box to bypass 802.1X authentication for client visibility.

NOTE

You can view statistical information about wired clients even without enabling 802.1X authentication.

- c. 802.1X Role: Select the authenticator role from the drop-down menu. Options include Supplicant, MAC-based Authenticator and Port-based Authenticator. When you select Supplicant, you can customize the username and password to authenticate as a supplicant role or use the credentials of the AP MAC address. When you select Port-based Authenticator, only a single MAC host must be authenticated for all hosts to be granted access to the network. If you select MAC-based Authenticator, each MAC address host is individually authenticated. Each newly-learned MAC address triggers an EAPOL request-identify frame.

5. Authentication and Accounting Services

- a. Authentication Server: Select the check-box and a controller from the drop-down menu to use the controller as a proxy authentication server.
 - b. Accounting Server: Select the check-box and a controller from the drop-down menu to use the controller as a proxy accounting server.
 - c. Enable MAC authentication bypass: Select this check-box if you want to use the device MAC address as access credentials (username and password).
6. RADIUS Options
- a. NAS ID: Set the NAS ID for the AP to communicate with the RADIUS server. Options include using the AP MAC address or any User-defined address.
 - b. Delimiter: If AP MAC is selected to configure the NAS ID, then you can choose between Dash or Colon as delimiters to separate.
7. Click **OK**.

You have created the Ethernet Port profile.

NOTE

You can also edit, clone and delete the profile by selecting the options **Configure**, **Clone** and **Delete** respectively, from the **Ethernet Port** tab.

Creating a Tunnel DiffServ Profile

If you need to configure the type of traffic (ToS) bit settings for the access side traffic from Ruckus Wireless APs, follow these steps to create a Differentiated Services (DiffServ) profile. This profile can only be applied to Ruckus GRE and SoftGRE traffic.

1. Go to **Services & Profiles > Tunnels and Ports**.
2. Select the **DiffServ** tab, and then select the zone for which you want to create the profile.

3. Click **Create**.

The **Create Tunnel DiffServ Profile** page appears.

FIGURE 107 Creating a Tunnel DiffServ Profile

Create Tunnel DiffServ profile

* Name:

Description:

* Tunnel DiffServ: Set Uplink DiffServ

Set Downlink DiffServ Downlink DiffServ only applies to RuckusGRE tunnel

Preserved DiffServ: Up to 8 preserved DiffServ allowed

4. Configure the following:

1. Name: Type a name for the DiffServ profile that you are creating.
2. Description: Type a brief description for the DiffServ profile.
3. Tunnel DiffServ: configure the following options.
 - a. Set Uplink DiffServ: Select the check box if you want to set the Differentiated Services field for uplink user traffic from Ruckus Wireless APs towards either the controller or a third SmartCell Gateway 200/Virtual SmartZone High-Scale for Release 3.4.1 Administrator Guide 92 Managing Ruckus Wireless AP Zones Creating a DiffServ Profile party gateway via SoftGRE. Configure the desired value to be set by the Ruckus Wireless AP.
 - b. Set Downlink DiffServ: Select the check box if you want to set the Differentiated Services field for downlink user traffic from the controller towards the AP, and then configure the desired value to be set by the Ruckus Wireless AP.
4. Preserved DiffServ: Configure up to eight (8) entries in the preserved DiffServ list. The Preserved DiffServ list allows the preservation of values that have been already marked in incoming packets either in uplink or downlink traffic.
5. Click **OK**.

You have created the DiffServ profile.

NOTE

You can also edit, clone and delete the profile by selecting the options **Configure**, **Clone** and **Delete** respectively, from the **DiffServ** tab.

Communications Assistance for Law Enforcement Act (CALEA)

The Communications Assistance for Law Enforcement Act is a law passed by the United States to enhance the ability of law enforcement agencies to conduct electronic surveillance by requiring that telecommunications carriers and manufacturers of telecommunications equipment to modify and design their equipment, facilities, and services to ensure that they have built-in surveillance capabilities.

NOTE

This feature only applies to the SmartZone 300 (SZ300) controller.

1. Go to **Services & Profiles > Tunnels and Ports**.
2. Select the **CALEA** tab.
3. Server IP: Type the CALEA server IP address.
4. Click **Create**.

The **Create UE MAC** page appears.

5. MAC Address: Type the MAC address of the client/user equipment for which CALEA mirroring is required. The MAC address is sent by the SZ controller to the vSZ-D.

Enabling Flexi VPN

You can enable Flexi-VPN and limit the network resources that a UE can access. Flexi-VPN allows an administrator to customize the network topology, and is thereby able to control the network resources accessible to the end-user. This feature is only supported on vSZ-E and vSZ-H, and is enabled by purchasing the Flexi-VPN license.

1. Go to **Services & Profiles > Tunnels and Ports**.

2. Select the **Forwarding Rule (vSZ-D)** tab.

The page with Flexi-VPN and L3 Roaming settings appears.

FIGURE 108 Enabling Flexi-VPN

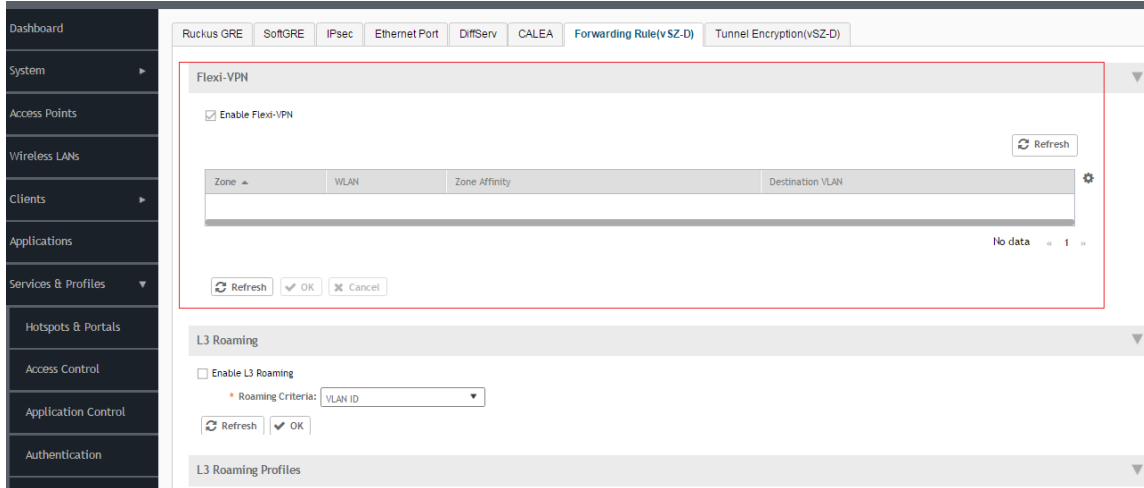

NOTE

The Flexi-VPN option is only available if the Access VLAN ID is 1, and when VLAN Pooling, Dynamic VLAN and Core Network VLAN options are disabled.

NOTE

You can only apply 1024 WLAN IDs to a Flexi-VPN profile.

Flexi-VPN supports IPv4 addressing formats and Ruckus GRE tunnel protocol. It does not support IPv6 addressing formats.

3. Select a virtual data plane for which you want to enable the Flexi-VPN feature, and then select the **Enable Flexi-VPN** check-box.
4. Click **OK**.

You have successfully enabled the Flexi-VPN feature on the selected vDP.

Enabling L3 Roaming Criteria for vDPs

Using the layer 3 roaming feature, clients can roam across APs in the network (from one data plane to another data plane). This is typically required when the number of clients in the network increases and clients have to roam from a network that they were connected to, to another WLAN network with similar access settings. This feature enables seamless roaming and ensures session continuity between the client and the network.

NOTE

L3 roaming is only supported on vSZ-H and vSZ-E.

You can configure the roaming criteria for a vDP so that it uses one of these two options - UE subnet or VLAN ID to access another vDP to connect to, within a network. Before this, you must ensure that the L3 roaming feature is enabled in the vDP.

1. Go to **Services & Profiles > Tunnels and Ports**.

2. Select the **Forwarding Rule (vSZ-D)** tab.

The page with Flexi-VPN and L3 Roaming settings appears.

FIGURE 109 Enabling L3 Roaming

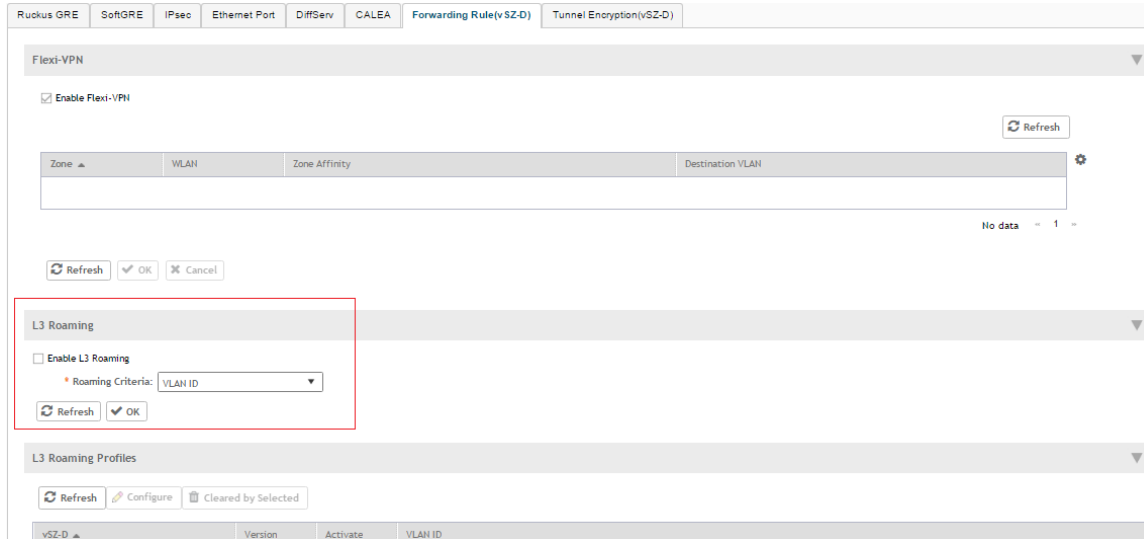

3. Select the **Enable L3 Roaming** check-box.
4. From the **Roaming Criteria** drop-down, select one of these options to define the data format to establish connection between vDPs: UE Subnet or VLAN ID.
5. Click **OK**.

You have successfully enabled L3 roaming, and also set the roaming criteria based on which vDPs would connect within the network.

NOTE

A fresh controller software installation or upgrade from a version that does not support L3 roaming resets the L3 roaming configuration and it remains disabled. You must enable L3 roaming on a vDP again.

Editing L3 Roaming for a vDP

For L3 roaming to work without session break, the vDPs between which the roaming happens must both be enabled with the L3 Roaming feature.

NOTE

If the IP address of the UE changes, then the session breaks.

1. Go to **Services & Profiles > Tunnels and Ports**.
2. Select the **Forwarding Rule (vSZ-D)** tab.

The page with Flexi-VPN and L3 Roaming settings appears.

- In L3 Roaming Profiles, select a virtual data plane for which you want to enable the L3 roaming feature, and then click **Configure**. The **Edit L3 Roaming** page appears.

FIGURE 110 Configuring the L3 Roaming setting for a vDP

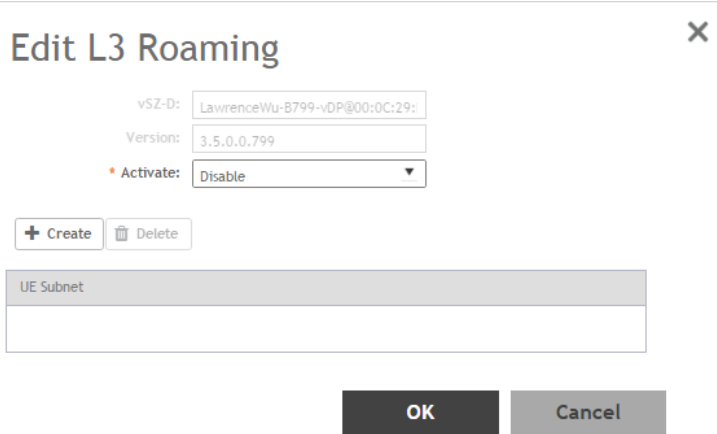

- In **Activate**, select Enable or Disable as appropriate.
- Based on the *Roaming Criteria* that you set, you will be able to add a UE subnet or a VLAN ID to the selected vDP. Click **Create** to add a UE Subnet or VLAN ID to the vDP. The **UE Subnet** or **Add VLAN ID** page appears, respectively, depending on the roaming criteria you chose.
- Type the **UE Subnet** IP address or the **VLAN ID** as appropriate.
- Click **OK**.
- Click **OK** again.

In L3 Roaming Profiles, the following information about the vDP is displayed:

- vSZ-D: Displays the name of the virtual data plane.
- Version: Displays the version of the vDP.
- Activate: Displays whether L3 roaming is enabled or disabled.
- UE Subnet or VLAN ID: Depending on the global settings you choose for the roaming criteria, the UE subnet IP address or the VLAN ID is displayed.

You have enabled L3 roaming in the selected vDP.

Enabling Tunnel Encryption

You can use the tunnel encryption feature to encrypt data for a private network, through a public network. This feature is available in vSZ-H and vSZ-E.

- Go to **Services & Profiles > Tunnels and Ports**.

2. Select the **Tunnel Encryption (vSZ-D)** tab, and then select the zone for which you want to create the profile.
The **Tunnel Encryption (vSZ-D)** page appears.

FIGURE 111 Tunnel Encryption (vSZ-D)

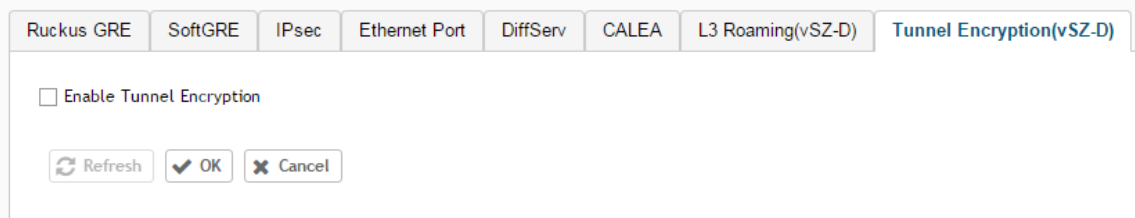

3. Select the **Enable Tunnel Encryption** check-box.
4. Click **OK**.

You have successfully enabled tunnel encryption.

Managing Core Network Tunnels

Tunneling protocols allows a user to access or provide a network service that the network does not support or provide directly.

Creating Bridge Forwarding Profiles

An Bridge forwarding profile defines the DHCP configuration for the core network.

1. Go to **Services & Profiles > Core Network Tunnel**.
2. Select the **Bridge** tab, and then select the zone for which you want to create the profile.

3. Click **Create**.
The **Create Bridge Forwarding Profile** page appears.

FIGURE 112 Creating a Bridge Forwarding Profile

Create Bridge Forwarding Profile

Name:

Description:

DHCP Relay ▼

Enabled DHCP Relay

DHCP Server 1:

DHCP Server 2: Send DHCP requests to both servers simultaneously

DHCP Option 82: Enable DHCP Option 82

Subopt-1 with format

Subopt-2 with format

Subopt-150 with VLAN-ID

Subopt-151 with format

OK **Cancel**

4. Configure the following:
 1. Name: Type a name for the profile that you are creating.
 2. Description: Type a brief description for the profile.
 3. DHCP Relay: Select the **Enable DHCP Relay** check-box and configure the DHCP server IP address and DHCP option 82 settings.
 - a. DHCP Server 1: Type the IPv4 address of the DHCP server that will allocate IP addresses to DHCP clients.
 - b. DHCP Server 2: If a secondary DHCP server exists on the network, type the IPv4 address of the secondary server.
 - c. DHCP Option 82: Select this check box if you want the DHCP relay agent (in this case, the controller) to insert specific identification information into requests that are forwarded to the DHCP server. If you enabled DHCP Option 82, you can configure the following Option 82 sub-options by selecting the corresponding check boxes:
 - Subopt-1 with format: You can customize sub-option 1 (Circuit ID) to send only the AP's MAC address in hexadecimal format or the MAC address and ESSID. The default format is: IFName:VLAN-ID:ESSID:AP-Model:AP-Name:AP-MAC.
 - Subopt 2 with format: You can customize sub-option 2 (Remote ID), which sends the client's MAC address by default, to send the AP's MAC address, or the client MAC plus ESSID or AP MAC plus ESSID.
 - Subopt-150 with VLAN ID: This sub-option encapsulates the VLAN ID.
 - Subopt-151 with format: This sub-option can encapsulate either the ESSID or a configurable Area Name.
 -
4. Click **OK**.

You have created the Bridge forwarding profile.

NOTE

You can also edit and delete the profile by selecting the options **Configure** and **Delete** respectively, from the **Bridge** tab.

Creating L2oGRE Forwarding Profiles

An L2oGRE forwarding profile defines the gateway and tunnel configuration for the core network of L2oGRE tunnels.

1. Go to **Services & Profiles > Core Network Tunnel**.
2. Select the **L2oGRE** tab, and then select the zone for which you want to create the profile.

3. Click **Create**.
The **Create L2oGRE Forwarding Profile** page appears.

FIGURE 113 Creating a L2oGRE Forwarding Profile

Create L2oGRE Forwarding Profile

* Name:

Description:

Core Network Gateway Settings

* Primary Gateway IP:

Secondary Gateway IP:

Gateway Path MTU: Auto Manual bytes (850-1500)

* ICMP Keep-Alive Period (secs):

* ICMP Keep-Alive Retry:

DHCP Relay

OK Cancel

4. Configure the following:
 1. Name: Type a name for the profile that you are creating.
 2. Description: Type a brief description for the profile.
 3. Core Network Gateway Settings
 - a. Primary Gateway IP: Type the IP address of the primary gateway for the L2oGRE tunnel.
 - b. Secondary Gateway IP: Type the IP address of the secondary gateway for the L2oGRE tunnel. If the primary gateway is unreachable, this gateway will be used for the L2oGRE tunnel.
 - c. Gateway Path MTU: Set it the MTU manually or use Auto (default). MTU is the size of the largest protocol data unit (in bytes) that can be passed on the controller network.
 - d. ICMP Keep-Alive Period (secs): Set the time in seconds between sending retry messages to the keepalive IP address. Enter an integer between 2 and 255. The default is 10 seconds.
 - e. ICMP Keep-Alive Retry: Set the retry period to send messages to the keepalive IP address. The default value is 3 retries.
 4. DHCP Relay: Select the **Enable DHCP Relay** check-box and configure the DHCP server IP address and DHCP option 82 settings.
 - a. DHCP Server 1: Type the IPv4 address of the DHCP server that will allocate IP addresses to DHCP clients.
 - b. DHCP Server 2: If a secondary DHCP server exists on the network, type the IPv4 address of the secondary server.
 - c. DHCP Option 82: Select this check box if you want the DHCP relay agent (in this case, the controller) to insert specific identification information into requests that are forwarded to the DHCP server. If you enabled DHCP Option 82, you can configure the following Option 82 sub-options by selecting the corresponding check boxes:
 - Subopt-1 with format: You can customize sub-option 1 (Circuit ID) to send only the AP's MAC address in hexadecimal format or the MAC address and ESSID. The default format is: IFName:VLAN-ID:ESSID:AP-Model:AP-Name:AP-MAC.
 - Subopt 2 with format: You can customize sub-option 2 (Remote ID), which sends the client's MAC address by default, to send the AP's MAC address, or the client MAC plus ESSID or AP MAC plus ESSID.
 - Subopt-150 with VLAN ID: This sub-option encapsulates the VLAN ID.
 - Subopt-151 with format: This sub-option can encapsulate either the ESSID or a configurable Area Name.
 -
5. Click **OK**.

You have created the L2oGRE forwarding profile.

NOTE

You can also edit and delete the profile by selecting the options **Configure** and **Delete** respectively, from the **L2oGRE** tab.

Location Services

If your organization purchased the Ruckus Wireless Smart Positioning Technology (SPoT) location service, the controller must be configured with the venue information that is displayed in the SPoT Administration Portal.

After completing purchase of the SPoT location service, you will be given account login information that you can use to log into the SPoT Administration Portal. The Admin Portal provides tools for configuring and managing all of your venues (the physical locations in which SPoT service is deployed). After a venue is successfully set up, you will need to enter the same venue information in the controller.

1. Go to **Services & Profiles > Location Services**.

The **Location Services** page appears.

FIGURE 114 Location Services

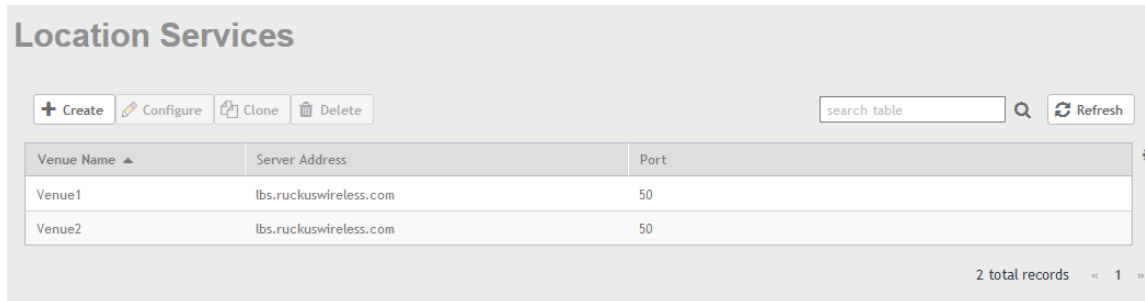

The screenshot shows the 'Location Services' page with a table containing two records. The table has columns for Venue Name, Server Address, and Port. Above the table are buttons for Create, Configure, Clone, and Delete, along with a search bar and a Refresh button. Below the table, it indicates '2 total records' and a page navigation indicator '« 1 »'.

Venue Name	Server Address	Port
Venue1	lbs.ruckuswireless.com	50
Venue2	lbs.ruckuswireless.com	50

2. Click **Create**.

The **Create LBS Server** page appears.

FIGURE 115 Creating an LBS Server

Create LBS Server

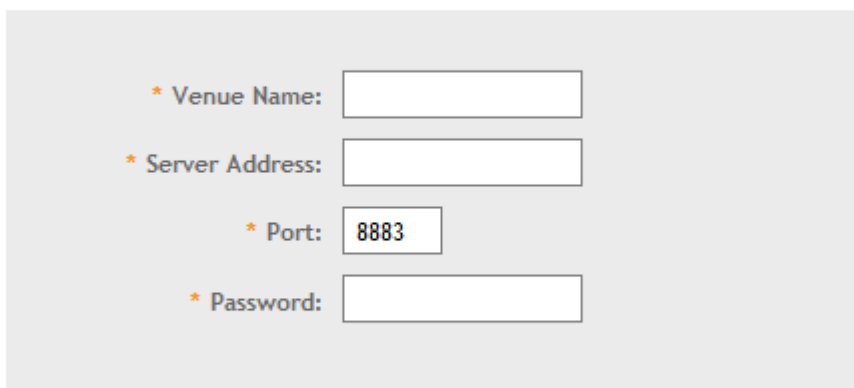

The screenshot shows a form titled 'Create LBS Server' with four required fields, each marked with an asterisk: Venue Name, Server Address, Port, and Password. The Port field contains the value '8883'. Below the form are two buttons: 'OK' and 'Cancel'.

3. Configure the following:
 1. Venue Name: Type a venue name for server.
 2. Server Address: Type the IP address of the server.
 3. Port: Type the port number to communicate with the server. Default is 8883.
 4. Password: Type the password to access the server.
 5. Click **OK**.

You have created the location-based service on the controller.

NOTE

You can also edit, clone and delete the service by selecting the options **Configure**, **Clone** and **Delete** respectively, from the **Location Services** tab.

DHCP/NAT

DHCP/NAT functionality on SZ-managed APs and DPs (data planes) allows customers to reduce costs and complexity by removing the need for DHCP server/NAT router to provide IP addresses to clients. For data traffic aggregation and services delivery you can choose appropriate user profile for DHCP and NAT services on vDP.

AP-based DHCP/NAT

In highly distributed environments, particularly those with only a few APs per site, the ability for an AP or a set of APs to provide DHCP/NAT support to local client devices simplifies deployment by providing all-in-one functionality on the AP, which eliminates the need for a separate router and DHCP server for each site. It also eases site management by providing central control and monitoring of the distributed APs and their clients.

Three general DHCP scenarios are supported:

- SMB Single AP: DHCP is running on a single AP only. This AP also functions as the Gateway AP.
- SMB Multiple APs (<12): DHCP service is running on all APs, among which two of the APs will be Gateway APs. These two Gateway APs will provide the IP addresses as well as Internet connectivity to the clients via NAT.
- Enterprise (>12): For Enterprise sites, an additional on site vDP will be deployed at the remote site which will assume the responsibilities of performing DHCP/NAT functions. Therefore, DHCP/NAT service will not be running on any APs (they will serve clients only), while the DHCP/NAT services are provided by the onsite vDP.

Profile-based DHCP

The DHCP Server is designed in-line in the data plane and provides extreme scale in terms of IP address assignment to clients. This feature is especially useful in high density and dynamic deployments like stadiums, train stations where large number of clients continuously move in & out of WiFi coverage. The DHCP server in the network needs to scale to meet these challenging requirements. The DHCP server on the vSZ-D provides high scale IP assignment and management with minimal impact on forwarding latency. By default, the maximum allowed IP assignment for the DHCP server is 50K IP addresses in a vSZ cluster managing multiple vDP. Additional IP assignment requires additional licensing.

NOTE

DHCP Server/NAT function if enabled is supported only for wireless client IPv4 address assignment.

Profile-based NAT

With NAT service enabled, all the WiFi client traffic is NATed by the vSZ-D before being forwarded to the core network. Each vSZ-D supports up to 900K NAT ports (traffic sessions) and 128 public IP addresses for NAT. This feature essentially reduces the network overhead significantly since this reduces the MAC-table considerations on the UP-stream switches significantly. Again, very useful in high density deployments.

Caveats and Limitations

The SmartZone DHCP on AP functionality has some limitations. These limitations should be considered before enabling this feature:

- Running DHCP/NAT services on an AP can consume significant memory resources. Therefore, Ruckus recommends deploying this feature only on APs with 256MB or more RAM.
- Max 4 IP address pools. Each pool must have non-overlapping IP addresses, and must be assigned a VLAN ID (2~4094).
- Max 1,000 IP addresses per pool.
- The following features are incompatible with the DHCP feature and cannot be enabled for a zone in which DHCP is enabled (or, if enabled for a zone, DHCP cannot be enabled or will be allowed but with a warning message):
 - IPv6
 - WeChat WLANs
 - Mesh (irrelevant for single-AP scenarios, configurable but with limitations for multi-AP scenarios)
 - DVLAN
 - VLAN Pooling
 - Bonjour Fencing
 - Client Isolation: If any WLAN within a zone uses a "Manual-Only" client isolation whitelist, DHCP cannot be enabled. Only Auto and Hybrid options are supported for zones with DHCP enabled.

Configuring AP-based DHCP Service Settings

Using DHCP service settings, you can configure an AP to assign private IP addresses to Wi-Fi clients without the need for a separate DHCP server (router).

To configure DHCP services:

1. Go to **Services & Profiles > DHCP & NAT**.
2. Select the **DHCP Setting (AP)** tab, and then select the zone for which you want to configure the settings.

3. Select a Zone from the zone list on the left side of the screen, and click **Enable DHCP Service on AP**.

FIGURE 116 Enabling DHCP Service

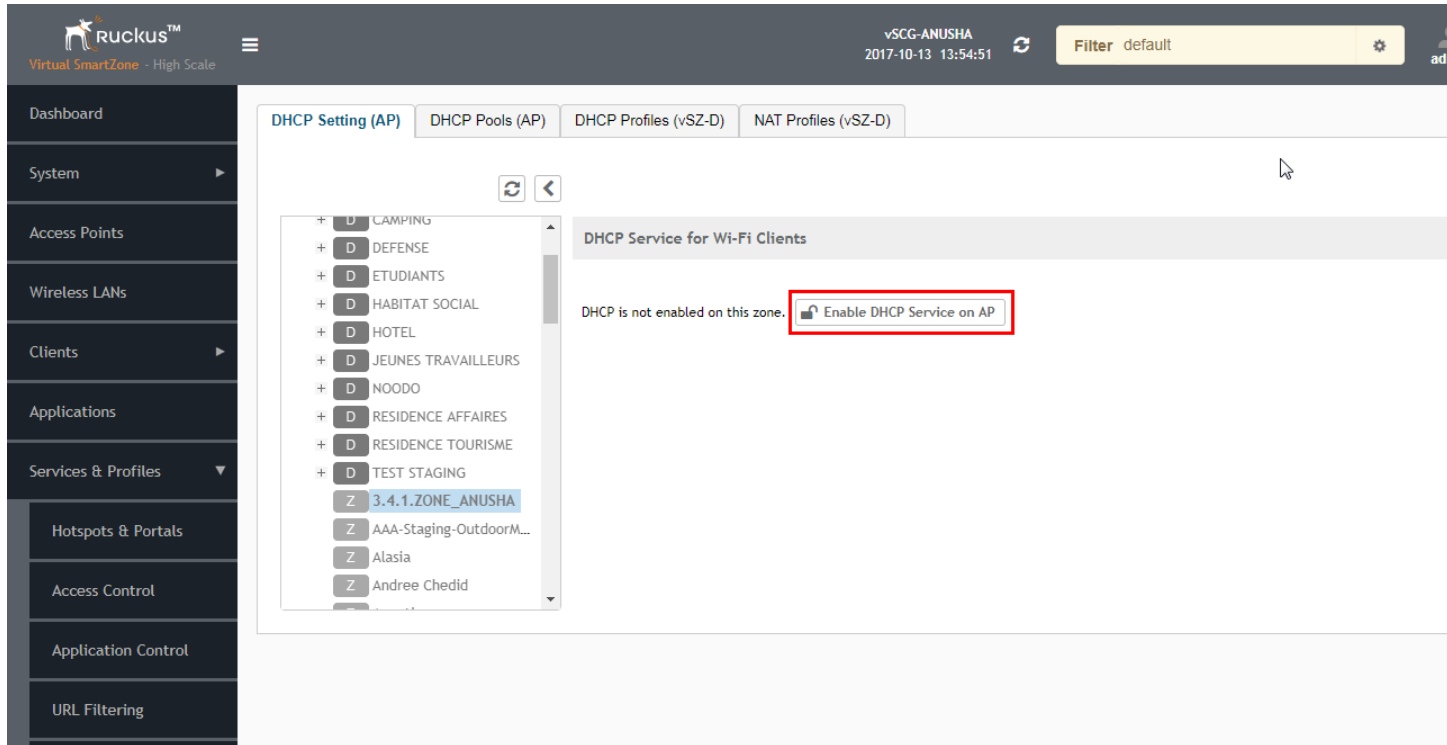

- Click **Edit DHCP Service on AP**. The **DHCP Settings** wizard appears.

FIGURE 117 DHCP Settings wizard

DHCP Settings

The screenshot shows the 'Base Settings' page of the DHCP Settings wizard. At the top, there is a progress bar with four steps: 'Base Settings' (highlighted), 'Select Profiles', 'Select APs', and 'Review'. Below the progress bar, there are two main sections for configuration:

- DHCP Configuration:** This section has two radio button options:
 - Enable on each AP**: Each AP in this zone is running its own DHCP server instance. Typically configured when APs are on different physical locations and roaming is not required.
 - Enable on multiple APs**: Designated APs in this zone are running DHCP Server instance. Typically configured when multiple APs are on the same physical location and roaming across AP is needed.
- DHCP AP Selection:** This section has two radio button options:
 - Auto Select AP**: Auto select sever and gateway APs.
 - Manually Select AP**: You would select server and gateway APs.

At the bottom right of the wizard, there are two buttons: 'Next' (dark grey) and 'Cancel' (light grey).

- On the first page of the wizard (**Base Settings**), configure the DHCP Configuration as follows:
 - Enable on Each AP:** Each AP in this zone runs its own DHCP server instance. This option is typically used when APs are at different sites and roaming is not required.
 - Enable on Multiple APs:** Designate which APs will provide DHCP/NAT service. This option is typically used when multiple APs are at the same site and roaming is required. This option also allows you to choose whether to automatically or manually specify which APs will provide DHCP service.

- On the next wizard screen, (**Select Pools**), select up to four DHCP pools from which to assign client IP addresses.

FIGURE 118 Selecting Pools

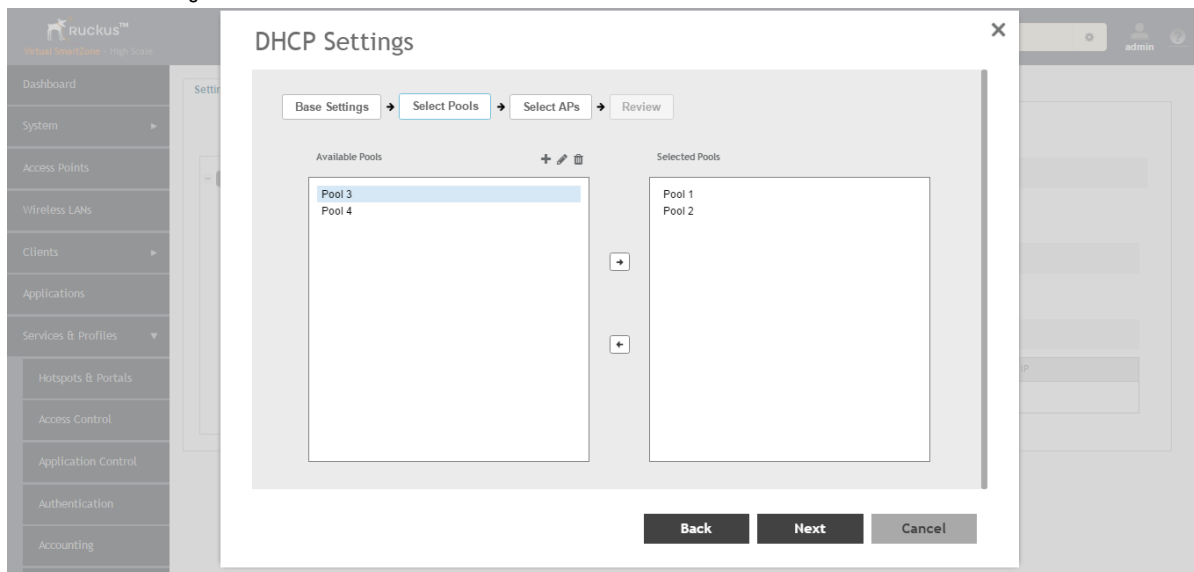

NOTE

If you have not already created DHCP pools, you can do so from within the wizard. Click the Plus (+) icon and configure the IP address pools as described in [Creating an AP DHCP Pool](#) on page 251.

- Click **Next**. The **Select APs** screen appears.

NOTE

If you selected **Auto Select AP** on the first wizard screen, this configuration screen will be skipped.

- On the **Select APs** wizard screen, select the AP(s) that you want to set as the primary and secondary DHCP servers (if you previously selected **Enable on Multiple APs**).

FIGURE 119 Selecting APs
DHCP Settings

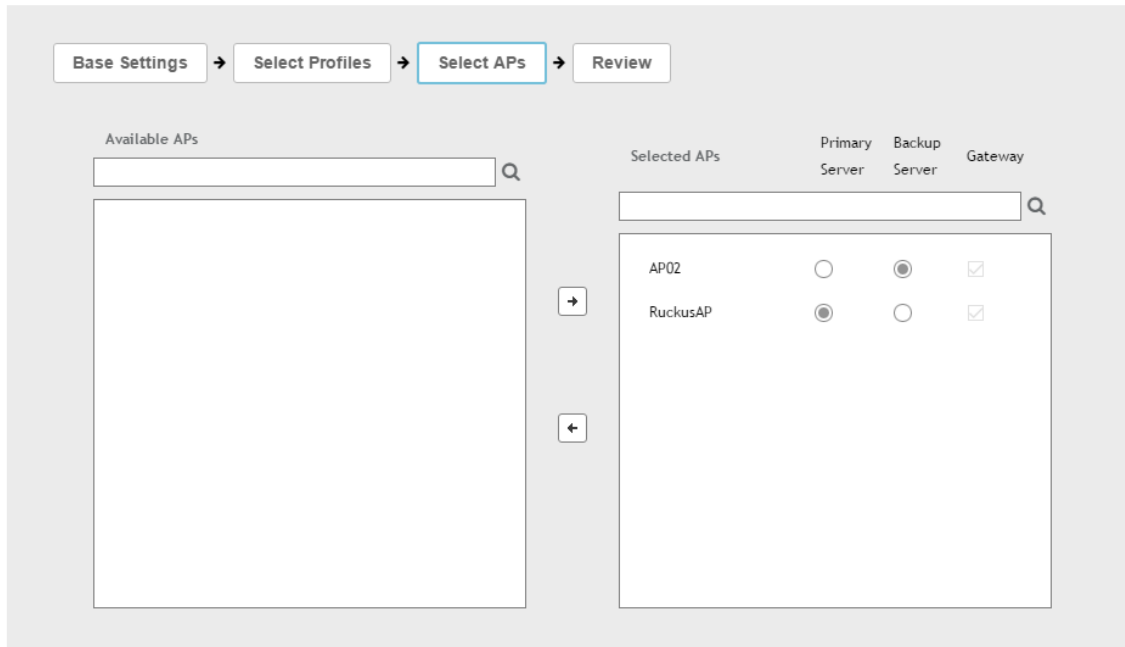

- Click **Next**.

- On the **Review** screen, review your settings to make sure everything is correct. Once you are satisfied with your settings, click **OK** to confirm.

FIGURE 120 Review DHCP settings

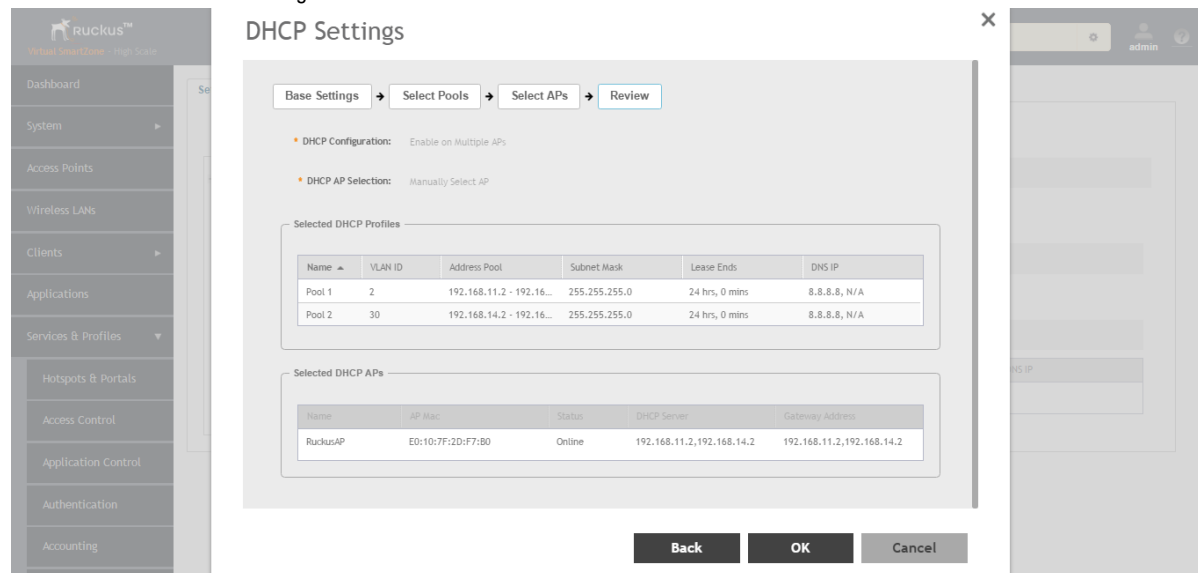

You have configured the DHCP server settings and applied them to an AP (or multiple APs). These APs will now provide DHCP/NAT functionality and assign IP addresses to wireless clients from the DHCP address pools you specified.

Creating an AP DHCP Pool

Creating a DHCP pool is necessary for assigning IP addresses to clients. Multiple address pools can be created and assigned to APs that are running DHCP services. Then, when a client connects to the wireless network, it will be assigned an address from the DHCP pool(s) you specified.

To configure a DHCP pool for IP address allocation:

- Go to **Services & Profiles > DHCP & NAT**.
- Select the **DHCP Pools (AP)** tab, and then select the zone for which you want to create the pool.

3. Click **Create**.
The **Create DHCP Pool** page appears.

FIGURE 121 Creating a DHCP Pool

Create DHCP Pool ✕

* Name:

Description:

* VLAN ID: (Range: 2~4094)

* Subnet / Network Address:

* Subnet Mask:

* Pool Start Address:

* [?] Pool End Address:

Primary DNS IP:

Secondary DNS IP:

* Lease Time: Hours Minutes

4. Configure the following:
 - **Name:** Type a name for the pool you want to create.
 - **Description:** Type a description of the pool you want to create.
 - **VLAN ID:** Type the vlan id for the pool.
 - **Subnet Network Address:** Type the IP subnet network address (e.g., 192.168.0.0).
 - **Subnet Mask:** Type the subnet mask address (e.g., 255.255.255.0).
 - **Pool Start Address:** Type the first IP address to be allocated to clients from the pool (e.g., 192.168.0.1).
 - **Pool End Address:** Type the last IP address to be allocated to clients from the pool (e.g., 192.168.0.253).
 - **Primary DNS IP:** Type the primary DNS server IP address.
 - **Secondary DNS IP:** Type the secondary DNS server IP address.
 - **Lease Time:** Enter the IP address lease time, after which clients will have to renew or request new IP addresses.
5. Click **OK**.

You have created a DHCP address pool. You can now apply this address pool to a DHCP service, as described in [Configuring AP-based DHCP Service Settings](#) on page 246.

NOTE

You can also edit, clone and delete the address pool by selecting the options **Configure**, **Clone** and **Delete** respectively, from the **Pool** tab.

Creating Profile-based DHCP

DHCP profile can be applied to vDP and the vDP server can assign IP to the UE based on the profile rule. Different pools with the same subnet can be created without overlapping IP range.

NOTE

DHCP supports only access-side network.

- [Configuring Global Settings](#) on page 253
- [Configuring DHCP Pool Settings](#) on page 254

Configuring Global Settings

To configure Profile-based DHCP Global settings:

1. Go to **Services & Profiles > DHCP & NAT > DHCP Profiles (DP)**.
2. Click **Create**, the Create DHCP Profile page appears.

3. Configure the following:
 - **Profile Name:** Type a name for the DHCP profile you want to create. AP supports 32 bytes.
 - **Description:** Type a description of the settings you want to create.
 - **Domain Name:** Type the domain name address.
 - **Primary DNS Server:** Type the primary domain name server address.
 - **Secondary DNS Server:** Type the secondary domain name server address.
 - **Lease Time:** Type the duration in Hours, Minutes and Seconds. Range: 1 through 86400 seconds.
 - **DHCP Option43 Space:** Click **Create**, the Create DHCP Option43 Space form appears. Configure the following:
 - **Space Name:** Type a name for Option43 space.
 - **Description:** Type a description for Option43 space.
 - Under **Option43 Sub Option**, click **Create** and configure the following:
 - › **Sub Option Name:** Type a sub option name.
 - › **Type:** Select the required option from the drop-down.
 - › **Code:** Enter a code. Range: 1 through 254.
 - › **Click OK**, you have created Option43 Sub Option.
 - Click **OK**, you have created Option43 Space.
 - **Hosts:** Click **Create**, the Create Host Configuration form appears. Configure the following:
 - **General Options**
 - › **Host:** Type a name for the host settings that you want to create.
 - › **Description:** Type a description for the host settings that you want to create.
 - **Policy Options**
 - › **Mac Address:** Type the MAC address of the DHCP host.
 - **Assigning Options**
 - › **Broadcast Address:** Type the broadcast IP address.
 - › **Fixed Address:** Type the fixed IP address of the host.
 - › **Gateway:** Type the gateway IP address.
 - › **DNS Server:** Type the IP address of the DNS server.
 - › **Domain Name:** Type the domain name.
 - › **Host Name:** Type the host name.
 - › **Lease Time:** Type the duration in Hours, Minutes and Seconds. Range: 1 through 86400 seconds.
 - Click **OK**, you have created DHCP Host configuration.
4. Click **OK**.

You have created DHCP Profile settings.

Configuring DHCP Pool Settings

To configure DHCP pool settings:

1. Go to **Services & Profiles > DHCP & NAT > DHCP Profiles (DP)**.
2. Select the DHCP profile from the list for which you want to configure the pool settings.
3. Select the **Pools** tab page.

4. Click **Create** and configure the following:
 - **General Options**
 - **Pool Name:** Type a name for the pool configuration.
 - **Description:** Type a description for the pool configuration.
 - **Policy Options**
 - **VLAN Range:** Type the VLAN range. Range: 1, 2 through 4095. For example: 1, 2 or 2-3.
 - **QinQ VLAN:** Select the check box and update the following:
 - › **QinQ SVLAN Range:** Type a SVLAN range. Range: 2 through 4095.
 - › **QinQ CVLAN Range:** Type a CVLAN range. Range: 2 through 4095.
 - **Assigning Options**
 - **Subnet:** Type the IP address.
 - **Subnet Mask:** Type the network address.
 - **Broadcast Address:** Type the broadcast IP address.
 - **Pool Range:** Type the address range for the pool.
 - **Exclude Pool:** Type the address range that must be excluded.
 - **Primary Gateway:** Type the primary gateway IP address.
 - **Secondary Gateway:** Type the secondary gateway IP address.
 - **Primary DNS Server:** Type the IP address of the primary DNS server.
 - **Secondary DNS Server:** Type the IP address of the secondary DNS server.
 - **Domain Name:** Type the domain name.
 - **Host Name:** Type the host name.
 - **Lease Time:** Type the duration in Hours, Minutes and Seconds. Range: 1 through 86400 seconds.
 - **Option43 Value**
 - Click **Create**, the Create Option43 value form appears. Configure the following:
 - › Choose the **Space Name** or click **Create** to configure Option 43 Space Name.
 - › Enter a **Description**.
 - Click **OK**, you have configured Option43 value.

5. Click **OK**.

You have created DHCP pool configuration.

Creating Profile-based NAT

A NAT Profile could be applied to a vDP. The NAT server settings work independently. You must configure the following settings to create a NAT profile:

NOTE

NAT does not support multiple public subnet/VLAN.

- [Configuring NAT Global Settings](#) on page 256
- [Configuring NAT Pool Setting](#) on page 256

Configuring NAT Global Settings

To create a NAT global setting:

1. Go to **Services & Profiles > DHCP & NAT > NAT Profiles (DP)**.
2. Click **Create**, the Create NAT Profile page appears.
3. Configure the following:
 - **Profile Name:** Type a name for the NAT profile that you want to create. AP supports 32 bytes.
 - **Description:** Type a description for the profile that you want to create.
 - **Subnet:** Type the IP address.
 - **Prefix:** Type a prefix value. Maximum range: 31.
 - **Public VLAN:** Type the VLAN range. Range: 2 through 4095.
 - **Gateway:** Type the gateway IP address.
4. Click **OK**.

You have created a NAT Profile.

Configuring NAT Pool Setting

To configure NAT pool settings

1. Go to **Services & Profiles > DHCP & NAT > NAT Profiles (DP)**.
2. Select the NAT profile from the list and click the **Pools** tab.
3. Click **Create**, the Create Pool Configuration page appears.
4. Configure the following:
 - **General Options**
 - **Pool Name:** Type a name for the NAT pool settings that you want to create.
 - **Description:** Type a description for the pool settings that you want to create.
 - **Policy Options**
 - **Private VLAN Range:** Type the VLAN range and click **Add**. Range: 1 through 4095. For example: 1 or 1-2.
 - **Private QinQ VLAN Range:** Type **SVLAN** range, **CVLAN** range and click **Add**. Range: 2 through 4095. For example: 2 or 2-3.
 - **Translation Options**
 - **Port Range:** Type the port range. Range: 10000 through 65534. For example: 10000-20000.
 - **Public Address Range:** Type the public address range.

Note: This public address must not be duplicated with the other public address in the same subnet, which includes applied NAT Profile and vSZ-D's Access and Core Interface Address.
5. Click **OK**.

You have created a NAT pool setting.

Working with Reports

- Types of Reports..... 257
- Managing Report Generation.....257
- Rogue Access Points..... 260
- Historical Client Stats..... 261
- Ruckus AP Tunnel Stats..... 262
- Core Network Tunnel Stats.....265

Types of Reports

The controller provides the following types of reports:

Client Number Report

The **Client Number** report shows a historical view of the maximum and minimum number of clients connect to the system.

Client number can be shown in different time intervals for a specified duration. The report can be generated based on a specific AP, SSID, or radio.

Continuously Disconnected APs Report

The Continuously Disconnected APs report shows a list of access points disconnected within the specified time range.

System Resource Utilization Report

The **System Resource Utilization** report shows a historical view of the CPU and memory usage of the system. The CPU and memory usage can be shown in different time intervals for a specific duration. The report can be generated based on specific plane.

TX/RX Bytes Report

The **TX/RX Bytes** report shows a historical view of the transmitted (TX) and received (RX) bytes of the system. The transmitted and received bytes can be shown in different time intervals for a specified duration. The report can be generated based on a specific AP, SSID or radio.

Managing Report Generation

You can create and manage reports.

NOTE

Global filter settings does not apply to the Reports feature.

As reports are segmented by individual administrators, each administrator's reports are unique and applies only to them.

Creating Reports

To create a new report:

1. From the left pane, select **Report > Report Generation**. [Figure 122](#) appears.

FIGURE 122 Report Generation Screen

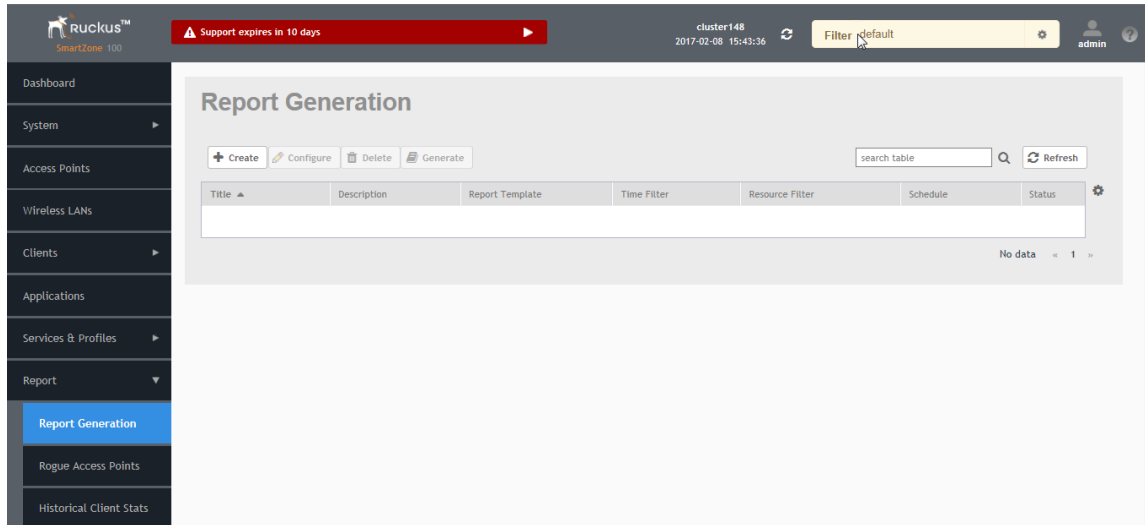

2. Click **Create**. [Figure 123](#) appears.

FIGURE 123 Create Reports Screen

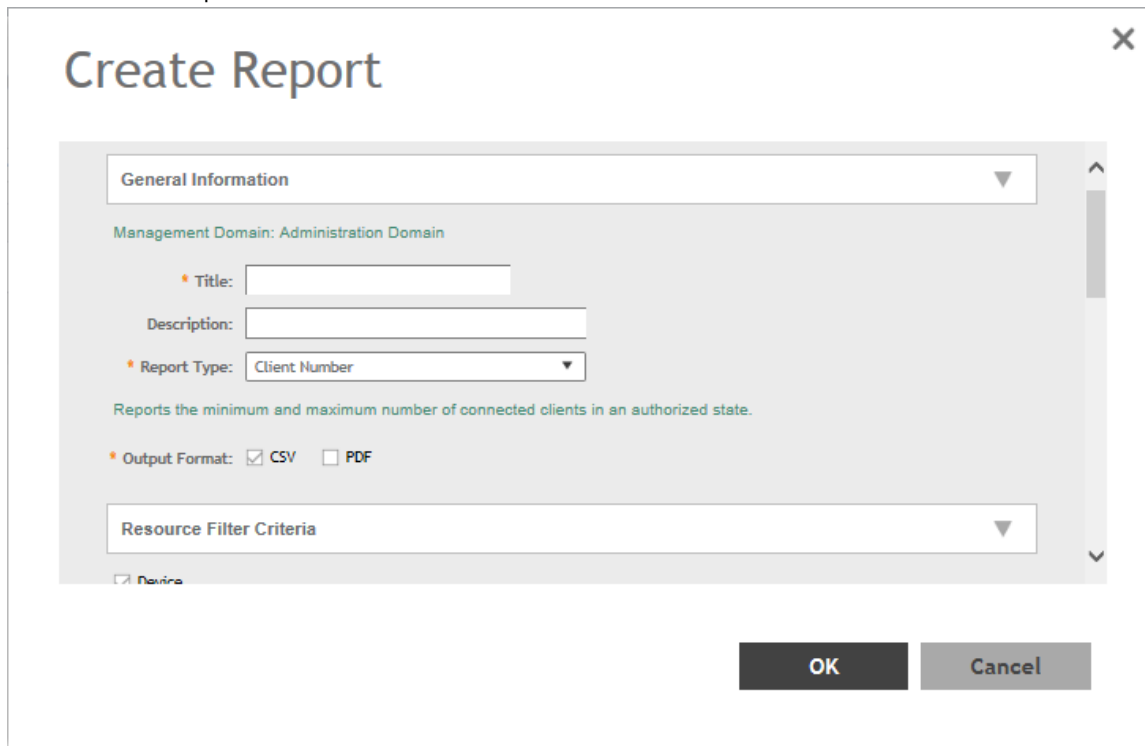

3. Enter the required parameters as explained in [Table 26](#).
4. Click **OK**.

TABLE 26 Report Parameters

Field	Description	Your Action
General Information		
Title	Indicates the report name.	Enter a title for the report.
Description	Describes the report type.	Enter a short description.
Report Type	Specifies the report type	Select the required report.
Output Format	Specifies the report output format.	Select the required report output format.
Resource Filter Criteria		
Device	Indicates the level of resource filtering for which you want to generate the report. For example: Managenemt Domains, AP Zone or Access Point.	Enter the Device name or select the Device from the list and choose the option.
SSID	Indicates the SSID for which you want to generate the report.	Select the check box and choose the SSID for which you want the report. You can select All SSIDs to generate reports for all the SSIDs available. This option is convenient as you do not have to update the resource filter criteria periodically.
Radio	Indicates the frequency for which you want to generate the report.	Select the check box and choose the required frequency: <ul style="list-style-type: none"> • 2.4G • 5G
Time Filter		
Time Interval	Defines the time interval at which to generate the report.	Select the required time interval.
Time Filter	Defines the time duration for which to generate the report.	Select the required time filter.
Schedules		
Enable/Disable	Specifies the scheduled time when a report must be generated. By default, the current system time zone is also displayed.	By default the option is disabled. Select Enable and select the Interval, Hour and Minute . You can add multiple schedules.
Email Notification		
Enable/Disable	Triggers an email notification when the report is generated.	By default the option is disabled. Select Enable and click the Add New and enter the email address. You can add multiple email addresses.
Export Report Results		
Export Report Results, Enable/Disable	Uploads the report results to an FTP server.	By default the option is disabled. Select Enable and select the FTP Server .

NOTE

You can also edit or delete a report by selecting the options **Configure** or **Delete** respectively.

Generating Reports

To generate a report:

1. From the left pane, select **Report > Report Generation**. [Figure 122](#) on page 258 appears.
2. Select the required report from the list and click **Generate**. The Report Generated form appears.

3. Click **OK**, the report will be generated and listed in the Report Results area.
4. Select the required format from the **Result Links** column and click **Open**.

Rogue Access Points

Viewing Rogue Access Points

Rogue (or unauthorized) APs pose problems for a wireless network in terms of airtime contention, as well as security.

Usually, a rogue AP appears in the following way: an employee obtains another manufacturer's AP and connects it to the LAN, to gain wireless access to other LAN resources. This would potentially allow even more unauthorized users to access your corporate LAN - posing a security risk. Rogue APs also interfere with nearby Ruckus Wireless APs, thus degrading overall wireless network coverage and performance.

The controller's rogue AP detection options include identifying the presence of a rogue AP, categorizing it as either a known neighbor AP or as a malicious rogue.

If you enabled rogue AP detection when you configured the common AP settings (see Configuring APs), click **Report > Rogue Access Points**. The Rogue Access Points page displays all rogue APs that the controller has detected on the network, including the following information:

- **Rogue MAC:** MAC address of the rogue AP.
- **Type:** Rogue, a normal rogue AP, not yet categorized as malicious or non-malicious.
- **Channel:** Radio channel used by the rogue AP.
- **Radio:** WLAN standards with which the rogue AP complies.
- **SSID:** WLAN name that the rogue AP is broadcasting.
- **Detecting AP Name:** Name of the AP.
- **Zone:** Zone to which the AP belongs.
- **RSSI:** Radio signal strength.
- **Encryption:** Indicates whether the wireless signal is encrypted or not.
- **Last Detected:** Date and time when the rogue AP was last detected by the controller.

Filtering Rogue Access Points

From the list of Rogue Access Points you can filter the required rogue APs based on Rogue MAC or Type.

To filter rogue APs:

1. From the Rogue Access Points page, click Settings  button. The Apply Filters form appears.
2. Enter the **Rogue MAC** ID or select the rogue AP **Type** from the drop-down.
3. Click **OK**. Filtered rogue APs appear in the list.

Marking Rogue Access Points

You can mark a Rogue (or unauthorized) AP as known.

To mark a Rogue AP as known:

1. From the left pane, click **Report** and **Rogue Access Points**. The Rogue Access Points page appears.
2. Select the Rogue AP from the list and click **Mark as Known**. The classification **Type** of the Rogue AP changes to **Known**. You can also select the Rogue AP from the list and click **Unmark**, to change the classification.

Locating a Rogue Access Point

You can identify the estimated location area of a rogue AP on a map. Managed APs that detect the rogue APs are also visible in the map.

To locate the Rogue AP:

1. From the left pane, click **Report** and **Rogue Access Points**. The Rogue Access Points page appears.
2. Select the Rogue AP from the list and click **Locate Rogue**. The Rogue AP Location pop-up window appears locating the rogue AP.
 - a) You can select:
 - **Map**-to view the location in street view
 - **Satellite**-to view the location as satellite imagery
 - **+**-to zoom in the location
 - **--**-to zoom out the location.
 - b) You can find the following information:
 - Rogue APs: MAC, Type, and SSID
 - Detecting APs: MAC, Name, and RSSI
3. Click **OK**.

Historical Client Stats

Viewing AP Client Statistics

AP Client Statistics is a cumulative value per session and one entry is created per session. Data is reported every 60 seconds and is not bin data. The user interface displays the table and its corresponding graph chart. The two representations are synchronized and controlled by the search criteria. For performance reasons, the total counters per DP or per GGSN IP for each bin is precalculated.

To view AP Client Statistics:

1. From the left pane, select **Report** > **Historical Client Stats**. The Ruckus AP Client page appears.
2. Update the parameters as explained in [Table 27](#).
3. Click:
 - **Load Data**— To view the report in the workspace.
 - **Export CSV**—To open or save the report in CSV file format.

TABLE 27 AP Client Statistics Report Parameters

Field	Description	Your Action
Time Period	Indicate the time period for which you want to view the report.	Move the slider to set the duration.

TABLE 27 AP Client Statistics Report Parameters (continued)

Field	Description	Your Action
Zone Name	Specifies the zone for which you want to view the report.	Enter the zone name or choose the zone from the list.
Client MAC	Specifies the MAC.	Enter the client MAC.
Client IP	Indicates the client IP.	Enter the client IP address.
MVNO Name	Indicates the mobile virtual network operator name.	Choose the MVNO.

Table 28 contains historical client statistics report based on the UE session statistics.

TABLE 28 AP Client Statistics Report Attributes

Attribute	Type	Description
Start	Long	Indicates the session creation time.
End	Long	Indicates the session end time.
Client MAC	String	Indicates the Mac address of the client.
Client IP Address	String	Indicates the IP address of the client.
Core Type	String	Indicates the core network tunnel type.
MVNO Name	String	Indicates the mobile virtual network operator name.
AP MAC	String	Indicates the Client AP MAC.
SSID	String	Indicates the SSID
Bytes from Client	Long	Indicates the number of bytes received from the client.
Bytes to Client	Long	Indicates the number of bytes sent to the client.
Packets from Client	Long	Indicates the number of packets received from the client.
Packets to Client	Long	Indicates the number of packets sent to the client.
Dropped Packets from Client	Long	Indicates the number of packets dropped from the client.
Dropped Packets to Client	Long	Indicates the number of packets dropped to the client.

Ruckus AP Tunnel Stats

Viewing Statistics for Ruckus GRE Tunnels

The web interface displays the table and its corresponding graph chart. The two representations are synchronized and controlled by the search criteria. For performance reasons, the total counters per DP or per AP for each bin may be pre-calculated.

To view the Ruckus GRE Tunnel Statistics:

1. From the left pane, select **Report > Ruckus AP Tunnel Stats**. The Ruckus GRE tab appears by default.
2. Update the parameters as explained in [Table 29](#).
3. Click:
 - **Load Data**— To view the report in the workspace.

- **Export CSV**— To open or save the report in CSV file format.

TABLE 29 Ruckus GRE Report Parameters

Field	Description	Your Action
Time Period	Indicate the time period for which you want to view the report.	Move the slider to set the duration.
Data Plane	Indicates the Data Plane.	Select the Data Plane.
AP MAC or IP Address	Indicates the MAC of the Access Point or IP Address.	Enter the AP MAC or IP address.
Zone Name	Specifies the zone for which you want to view the report.	Enter the zone name or select the zone from the list.

Table 30 contains the report based on the statistics for Ruckus GRE. Each entry contains the 15 minutes cumulative data.

TABLE 30 Ruckus GRE report attributes

Attribute	Type	Description
Time	Long	Bin ID, which is stamped at a 15 minute interval. For example, 10:00, 10:15.
TXBytes	Long	Indicates the number of bytes sent.
RXBytes	Long	Indicates the number of bytes received.
TXPkts	Long	Indicates the number of packets sent.
RXPkts	Long	Indicates the number of packets received.
Dropped Packets	Long	Indicates the number of packets dropped.

Viewing Statistics for SoftGRE Tunnels

The web interface displays the table and its corresponding graph chart. The two representations are synchronized and controlled by the search criteria. For performance reasons, the total counters per DP or per AP for each bin may be pre-calculated.

To view the SoftGRE Tunnel Statistics:

1. From the left pane, select **Report > Ruckus AP Tunnel Stats**. The Ruckus GRE tab appears by default.
2. Select **SoftGRE**. Update the parameters as explained in Table 31.
3. Click:
 - **Load Data**— To view the report in the workspace.
 - **Export CSV**— To open or save the report in CSV file format.

TABLE 31 SoftGRE Report Parameters

Field	Description	Your Action
Time Period	Indicate the time period for which you want to view the report.	Move the slider to set the duration.
Zone Name	Specifies the zone for which you want to view the report.	Select the required zone.
Gateway Address	Specifies the gateway address	Enter the gateway address.
AP MAC or IP Address	Indicates the MAC of the Access Point or IP Address.	Enter the AP MAC or IP address.

Table 32 contains the report based on the statistics for SoftGRE. Each entry contains the 15 minutes cumulative data.

TABLE 32 SoftGRE Report Attributes

Attribute	Type	Description
Time	Long	Bin ID, which is stamped at a 15 minute interval. For example, 10:00, 10:15.
TXBytes	Long	Indicates the number of bytes sent.
RXBytes	Long	Indicates the number of bytes received.
TXPkts	Long	Indicates the number of packets sent.
RXPkts	Long	Indicates the number of packets received.
RX Dropped Packets	Long	Indicates the number of packets dropped.
TX Dropped Packets	Long	Indicates the number of packets dropped.
TX Error Packets	Long	Indicates the number of packets with a header error.
RX Error Packets	Long	Indicates the number of packets with a header error.

Viewing Statistics for SoftGRE IPsec Tunnels

The web interface displays the table and its corresponding graph chart. The two representations are synchronized and controlled by the search criteria. For performance reasons, total counters per DP or per AP for each bin may be pre-calculated.

To view the SoftGRE IPsec Tunnel Statistics:

1. From the left pane, select **Report > Ruckus AP Tunnel Stats**. The Ruckus GRE tab appears by default.
2. Select **SoftGRE + IPsec**. Update the parameters as explained in [Table 33](#).
3. Click:
 - **Load Data**— To view the report in the workspace.
 - **Export CSV**—To open or save the report in CSV file format.

TABLE 33 SoftGRE + IPsec Report Parameters

Field	Description	Your Action
Time Period	Indicate the time period for which you want to view the report.	Move the slider to set the duration.
Zone Name	Specifies the zone for which you want to view the report.	Select the required zone.
Gateway Address	Specifies the gateway address	Enter the gateway address.
AP MAC or IP Address	Indicates the MAC of the Access Point or IP Address.	Enter the AP MAC or IP address.

[Table 34](#) contains the report based on the statistics for access point IPsec. Each entry contains the 15 minutes cumulative data.

TABLE 34 SoftGRE + IPsecReport Attributes

Attribute	Type	Description
Time	Long	Bin ID, which is stamped at a 15 minute interval. For example, 10:00, 10:15.
TXBytes	Long	Indicates the number of bytes sent.
RXBytes	Long	Indicates the number of bytes received.
TXPkts	Long	Indicates the number of packets sent.
RXPkts	Long	Indicates the number of packets received.
TX Dropped Packets	Long	Indicates the number of packets dropped.

TABLE 34 SoftGRE + IPsecReport Attributes (continued)

Attribute	Type	Description
RX Dropped Packets	Long	Indicates the number of packets dropped.

Core Network Tunnel Stats

Viewing Statistics for SoftGRE Core Network Tunnel

To view Stats for SoftGRE Core Network Tunnel:

1. From the left pane, select **Report > Core Network Tunnel Stats**. The SoftGRE page appears.
2. Update the parameters as explained in [Table 35](#).
3. Click:
 - **Load Data**— To view the report in the workspace.
 - **Export CSV**—To open or save the report in CSV file format.

TABLE 35 SoftGRE Core Network Tunnel Parameters

Field	Description	Your Action
Time Period	Indicate the time period for which you want to view the report.	Move the slider to set the duration.
Data Plane	Indicates the Data Plane.	Select the Data Plane.
Gateway IP Address	Indicates the gateway IP Address.	Enter the gateway IP address.
MVNO Name	Indicates the mobile virtual network operator name.	Choose the MVNO name.

[Table 36](#) contains the report based on the statistics for SoftGRE core network tunnel.

TABLE 36 SoftGRE Core Network Tunnel Attributes

Attribute	Type	Description
Time	Long	Bin ID, which is stamped at a 15 minute interval. For example, 10:00, 10:15.
TX Bytes	Long	Indicates the number of bytes sent.
RX Bytes	Long	Indicates the number of bytes received.
TX Packets	Long	Indicates the number of packets sent.
RX Packets	Long	Indicates the number of packets received.
Dropped Packets	Long	Indicates the number of packets dropped.

Troubleshooting

- Troubleshooting Client Connections.....267
- Troubleshooting through Spectrum Analysis..... 268

Troubleshooting Client Connections

This feature allows network administrators to connect to client devices and analyze network connection issues in real-time.

The network administrator types the MAC address of the client device and starts various services to identify the connectivity issue. The APs assigned to the client device relay data frames from the device to the controller which the administrator analysis to determine which stage of the connection is causing problems.

1. Go to **Troubleshooting**.

The **Troubleshooting** page appears.

FIGURE 124 Troubleshooting - Client Connections

Troubleshooting

1 Type: Client Connection

2 Client MAC: 18:AF:61:60:49:0F

3 Select APs: Select Total APs: 1

4 Connectivity Trace Start Stop Clear

Access Points hearing client's probe requests:

Name	Radio	Client SNR(dBm)	Latency(ms)	Connection Failure(%)	Airtime Utilization(%)
✓ RuckusAP (e0:10:7f:23:da:b0)	5GHz (149)	42	8192	0	45

AP: RuckusAP (e0:10:7f:23:da:b0) SSID: eng-ste.chu-psk3 Radio: 5GHz Time: 10:15:29

- ✓ 802.11 Authentication Request
- ✓ 802.11 Authentication Response
- ✓ 802.11 Association Request
- ✓ 802.11 Association Response
- ✓ 4-Way Handshake - Frame 1
- ✓ 4-Way Handshake - Frame 2
- ✓ 4-Way Handshake - Frame 3
- ✓ 4-Way Handshake - Frame 4
- ✓ DHCP Discover

2. In Type, select **Client Connection** from the drop-down menu.
3. In Client MAC, type the MAC address of the client device which is facing connectivity issues.
4. In Select APs, click **Select**.

The **Select APs** page appears. Select an AP to communicate between the client and controller and then click **OK**.

5. In Connectivity Trace, click **Start**.

The controller configures the APs to receive data frame from the target client so that the APs can relay relevant frames that match the client filter to the controller.

The APs that receive probe requests from the target client are listed in a table along with the APs operating channel and the RSSI at which the client's frames were received. This stage of the connection identifies whether there are acceptable APs for the client to connect to.

Following are the details displayed in the table:

- AP Name and MAC Address.
- Radio: Identifies the 2.4 or 5 GHz radio of the AP and the channel number the radio is operating on.
- Client SNR: This is the signal-to-noise ratio received in dB.
- Latency: Time delay in connecting the AP to the client.
- Connection Failures: Displays the percentage of AP-client connection attempts that failed.
- Airtime Utilization: Percentage of the air time that was used by the client to transfer data.

AT this stage, the tool displays the statuses `Client is in a discovery state and not currently connected`(when the tool starts/when the client is already connected to an AP) and `Client is attempting a new connection`(when the target client sends an 802.11 authentication request frame to an AP to initiate a connection.).

By using the list of APs that communicated with the client, you will be able to identify if the client chose the best AP based on signal quality and other health metrics.

When the client sends an 802.11 authentication request frame, a flow diagram depicting different stages of the AP-client connection is initiated. This sends a trigger frame to the AP and it is highlighted from the list for reporting APs.

The *Flow ladder* in the diagram shows the step-by-step exchange of information between devices during the connection process. As the steps are completed, colored arrows are displayed based on whether the step depicts a warnings (yellow) or event (for example, red for failure). Typical warning scenarios include time delays or when a client negotiates and EAP type that's not supported. Failure conditions are also highlighted as red arrows typically when the connection itself fails.

6. Click **Stop** to terminate connection between the AP and client.

NOTE

The following authentication types are supported:

- Open
- PSK (WPA2-Personal)
- 802.1X (PEAP, TTLS, TLS, SIM)
- WISPr

Troubleshooting through Spectrum Analysis

Interference between wireless devices is seen to increase dramatically due to the increase in the number of device used, and the availability of only three non-interfering channels in 802.11. This reduces the performance of the wireless network, therefore, it is important to monitor the spectrum usage in a particular area and efficiently allocate the spectrum as needed to wireless devices.

In addition, spectrum analysis provides the flexibility to troubleshoot issues remotely, identify sources of interferences within the network and allow administrators access to the RF health of the network environment.

APs which are put in spectrum-mode transmit data to the controller, which in turn displays the data in spectrum-mode for analysis.

1. Go to **Troubleshooting**.

The **Troubleshooting** page appears.

FIGURE 125 Troubleshooting - Spectrum Analysis

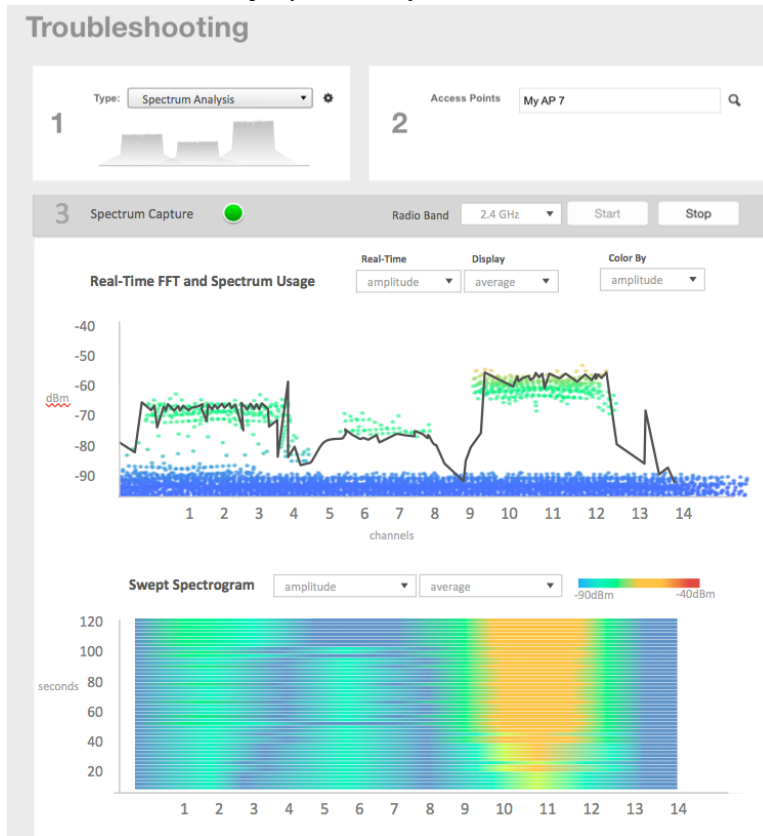

2. In Type, select **Spectrum Analysis** from the drop-down menu.
3. In AP MAC Address, select the AP that needs to be in the spectrum analysis-mode.

Troubleshooting

Troubleshooting through Spectrum Analysis

4. In Spectrum Capture, select the radio frequency values (2.4GHz or 5GHz) for the analysis from the **Radio** option.

The 2.4GHz band spans from 2400 - 2480 GHz and 5GHz band spans from 5.15 - 5.875 GHz.

You can select and view the spectrum analysis trends in these graphs:

- **Spectrum Usage:** This chart uses a color-based view to show collections of data points over time. As more data samples are measured at a specific frequency and amplitude coordinate, the color shown at that coordinate will change. If you choose to view colors by amplitude, the warm colors depict higher amplitude and cool colors lower amplitudes. If you view the colors by density, the warm colors depict a high number of samples at a given coordinate and cool colors show low number of samples at a given coordinate.
- **Real-Time FFT :** This chart is a second-by-second (2sec) update of measured data across the band. If you view by Amplitude (signal strength), then the chart displays both average and maximum amplitudes of energy measured across the band for that sample period. If you view by Utilization (duty cycle), then the chart displays the percentage (%) of time at which the frequency is utilized at an amplitude above N. The amplitude threshold is configurable but the default is -85dBm.
- **Swept Spectrogram:** This chart displays a waterfall of color over time, where each horizontal line in the waterfall represents one sample period (e.g. 2 seconds), and the full waterfall display spans 2 minutes of time (60 sample bins of 2sec each). There are two display options for the spectrogram chart:
 - **Amplitude:** Shows both average and maximum amplitude of energy measured across the band for that sample period.
 - **Utilization:** Shows the percentage of time at which the frequency is utilized at an amplitude above N. The amplitude threshold is configurable but the default is -85dBm.

5. After you select the parameters that you want to use to view the graphs, click **Start**.

6. Click **Stop** to terminate viewing spectrum analysis trends.

Administering the Controller

- Managing Administrator and Roles.....271
- Backing Up and Restoring Clusters.....275
- Upgrading the Controller.....286
- Managing Licenses.....290
- ZoneDirector to SmartZone Migration.....293
- Monitoring Administrator Activities.....294
- Managing Mobile Virtual Network Operator (MVNO) Accounts.....294

Managing Administrator and Roles

The controller must be able to manage various administrators and roles that are created within the network in order to assign tasks and functions, and to authenticate users.

Creating User Groups

Creating user groups and configuring their access permissions, resources and administrator accounts allows administrators to manage a large number of users.

1. Go to **Administration > Admins and Roles**.
2. Select the **Groups** tab.
3. Click **Create** after selecting the system domain.
The **Create User Group** page appears.
4. Configure the following:
 1. Permission
 - a. Name: Type the name of the user group you want to create.
 - b. Description: Type a short description for the user group you plan to create.
 - c. Permission: Select one of the access permission for the user group, from the drop-down menu. You can also grant admin permission to generate guest passes.
 - d. Click **Next**.
 2. Resource: From Select Resources, add the resources you want to assign to this user group.
 3. Click **Next**.
 4. Domain: Select the domain from the list of domains to which this user group will be associated.
 5. Click **Next**.
 6. Administrator: Select the users available in the list and add them under Selected User. You can also create Administrator accounts for the group from this page.
 7. Click **Next**.
 8. Review: Verify the user group's configuration that you have selected.
 9. Click **OK** to confirm.

You have created the user groups.

NOTE

You can also edit and delete the group configuration by selecting the options **Configure**, and **Delete** respectively, from the **Groups** tab.

Creating Administrator Accounts

The controller supports the creation of additional administrator accounts. This allows you to share or delegate management and monitoring functions with other members of your organization.

1. Go to **Administration > Admins and Roles**.
2. Select the **Administrators** tab.
3. Click **Create**.

The **Create Administrator Account** page appears.

FIGURE 126 Creating an Administrator Account

Create Administrator Account

* Account Name:

Real Name:

* Password:

* Confirm Password:

Phone:

Email:

Job Title:

OK **Cancel**

4. Configure the following:
 1. Account Name: Type the name that this administrator will use to log on to the controller.
 2. Real Name: Type the actual name (for example, John Smith) of the administrator.
 3. Password: Type the password that this administrator will use (in conjunction with the Account Name) to log on to the controller.
 4. Confirm Password: Type the same password as above.
 5. Phone: Type the phone number of this administrator.
 6. Email: Type the email address of this administrator.
 7. Job Title: Type the job title or position of this administrator in your organization.
 8. Click **OK**.

You have created the administrator account.

NOTE

You can also edit and delete the admin account by selecting the options **Configure**, and **Delete** respectively, from the **Administrator** tab.

Creating a RADIUS Server for Administrator Authentication

You can add RADIUS servers that you want to use for authorizing and authenticating administrators.

1. Go to **Administration > Admins and Roles**.
2. Select the **AAA** tab.
3. Click **Create**.

The **Create Administrator RADIUS Server** page appears.

FIGURE 127 Creating an Administrator RADIUS Server

The screenshot shows a web-based configuration form titled "Create Administrator RADIUS Server". The form contains the following fields and options:

- Name:** A text input field.
- Type:** Radio buttons for **RADIUS** (selected) and **TACACS+**.
- Realm:** A text input field with a note below it: "Multiple realms supported. Use a comma (,) to separate realms (for example, home1,home2)."
- Backup RADIUS:** A checkbox labeled "Enable Secondary Server" which is currently unchecked.
- IP Address:** A text input field.
- Port:** A text input field containing the value "1812".
- Shared Secret:** A text input field.
- Confirm Secret:** A text input field.

At the bottom of the form are two buttons: **OK** and **Cancel**.

4. Configure the following:
 1. Name: Type a name for the RADIUS server.
 2. Type: Select the type of RADIUS server that you are using. Options include:
 - RADIUS: Click this option to use a Remote Authentication Dial-In User Service (RADIUS) server on the network for authenticating controller administrators.
 - TACACS+: Click this option to use a Terminal Access Controller Access-Control System Plus (TACACS+) server on the network for authentication controller administrators.
 3. Realm: Type the realm (or realms) to which the RADIUS server belongs. If the RADIUS server belongs to multiple realms, use a comma (,) to separate the realm names.
 4. Backup RADIUS: Select the Enable Secondary Server to back up the RADIUS server configuration.
 - a. Primary Server: Type the IP address, port, shared secret for the primary server that needs to be backed up.
 - b. Secondary Server: Type the IP address, port, shared secret for the secondary server to which the back must be done.
 - c. Failover Policy at NAS:
 - Request Timeout: Type the timeout period (in seconds) after which an expected RADIUS response message is considered to have failed.
 - Max Number of Retries: Type the number of failed connection attempts after which the controller will fail over to the backup RADIUS server.
 - Reconnect Primary: Type the number of minutes after which the controller will attempt to reconnect to the primary RADIUS server after failover to the backup server.
 5. IP Address: Type the IP address of the RADIUS server.
 6. Port: Type the UDP port that the RADIUS server is using. The default port is 1812.
 7. Shared Secret: Type the shared secret.
 8. Confirm Secret: Retype the same secret in.
 9. Click **OK**.

You have completed adding a RADIUS server for authenticating administrators.

NOTE

You can also edit, clone and delete the server by selecting the options **Configure**, **Clone** and **Delete** respectively, from the **Administrator** tab.

Enabling the Access Control List

You can control access to management interfaces from CLI or SSH.

1. Go to **Administration > Admins and Roles**.
2. Select the **Access Control List** tab.
3. Select **Enable**.

4. Click **Create**.

The **Management Interface Access Control Rule** page appears.

FIGURE 128 Management Interface Access Control Rule

Management Interface Access Control Rule

The screenshot shows a configuration form for a Management Interface Access Control Rule. It includes the following fields and options:

- Name:** A text input field with an asterisk indicating it is required.
- Description:** A text input field.
- Type:** Three radio button options: **Single IP** (selected), **IP Range**, and **Subnet**.
- Single IP:** A sub-section containing an **IP Address:** text input field with an asterisk.

At the bottom right of the form are two buttons: **OK** and **Cancel**.

5. Configure the following:
 1. **Name:** Type the name that rule you want to create to access the management interface.
 2. **Description:** Type a short description for the rule.
 3. **Type:** Select one of the following
 - **Single IP:** Type the IP address of the interface that can be accessed per this rule.
 - **IP Range:** Type the range of IP address that will be allowed access.
 4. **Subnet:** Type the network address and subnet mask address of the interface that will be allowed access.
 5. Click **OK**.

You have created the access control list rule.

NOTE

You can also edit and delete the list by selecting the options **Configure** and **Delete** respectively, from the **Access Control List** tab.

Backing Up and Restoring Clusters

Back up the controller cluster periodically to ensure that you can restore the control plane, data plane, and AP firmware versions as well as the system configuration in the cluster if a system failure occurs.

Creating a Cluster Backup

Backing up the cluster (includes OS, configuration, database and firmware) periodically enables you to restore it in the event of an emergency. Ruckus Wireless also recommends that you back up the cluster before you upgrade the controller software.

1. Go to **Administration > Backup and Restore**.
2. Select the **Cluster** tab.

Administering the Controller

Backing Up and Restoring Clusters

3. In Cluster Backup and Restore, click **Backup Entire Cluster** to backup both nodes in a cluster.

The following confirmation message appears: `Are you sure you want to back up the cluster?`

4. Click **Yes**.

The following message appears: `The cluster is in maintenance mode. Please wait a few minutes.`

When the cluster backup process is complete, a new entry appears in the **Cluster Backups History** section with a **Created On** value that is approximate to the time when you started the cluster backup process.

Restoring a Cluster Backup

You must be able to restore a cluster to its previous version in the case of a failure.

1. Go to **Administration > Backup and Restore**.
2. Select the **Cluster** tab.
3. In Cluster Backup History, select the cluster and click **Restore**.

The following confirmation message appears:

`Are you sure you want to restore the cluster?`

4. Click **Yes**.

The cluster restore process may take several minutes to complete. When the restore process is complete, the controller logs you off the web interface automatically.

ATTENTION

Do not refresh the controller web interface while the restore process is in progress. Wait for the restore process to complete successfully.

5. Log on to the controller web interface.

If the web interface displays the message `Cluster is out of service. Please try again in a few minutes` appears after you log on to the controller web interface, wait for about three minutes. The dashboard will appear shortly. The message appears because the controller is still initializing its processes.

6. Go to **Administration > Upgrade**, and then check the **Current System Information** section and verify that all nodes in the cluster have been restored to the previous version and are all in service.
7. Go to **Diagnostics > Application Logs**, and then under **Application Logs & Status** check the **Health Status** column and verify that all of the controller processes are online.

You have completed restoring the cluster backup.

Backing Up and Restoring the Controller's Network Configuration from an FTP Server

In addition to backing up and restoring the controller's network configuration from its own database, the controller supports backup and restore of its network configuration from an FTP server using the CLI.

This section describes the requirements for backing up and restoring the controller's network configuration from an FTP server, the information that is included in the backup file, and how to perform the backup and restore process.

To back up and restore the controller's network configuration from an FTP server, the controller must have already been set up and in service. In case of a multi-node cluster, all the nodes in the cluster must be in service.

The following table lists the network configuration that is backed up from the control and data planes when you perform a backup procedure to an FTP server.

TABLE 37 Information that is backed up to the FTP server

Control Plane	Data Plane
<ul style="list-style-type: none"> Control interface Cluster interface Management interface Static routes User-defined interfaces 	<ul style="list-style-type: none"> Primary interface Static routes Internal subnet prefix

Backing Up to an FTP Server

Follow these steps to back up the controller network configuration to an FTP server.

1. Log on to the controller from the controller's command line interface (CLI). For more information, see the corresponding *Command Line Interface Reference Guide* for your controller platform.
2. At the prompt, enter **en** to enable privileged mode.

```
cb172651> en
Password: *****
```

FIGURE 129 Enable privileged mode

3. Enter **-** to display the statuses of the node and the cluster.

Before continuing to the next step, verify that both the node and the cluster are in service.

FIGURE 130 Verify that both the node and the cluster are in service

```
cb172651# show cluster-state
Current Node Status : In service
Cluster Status      : In service
Cluster Operation   : None
System Mode         : None
```

4. Enter backup network to back up the controller network configuration, including the control plane and data plane information.
The controller creates a backup of its network configuration on its database.

FIGURE 131 Run backup network

```
#####  
#      Welcome to SCG      #  
#####  
Password:  
Please wait. CLI initializing...  
  
Welcome to the Ruckus SmartCell Gateway 200 Command Line Interface  
Version: 2.5.0.0.402  
  
cb172651> en  
Password: *****  
  
cb172651# backup network  
Do you want to backup network configurations (or input 'no' to cancel)? [yes/no] yes  
Starting to backup network configurations...  
Successful operation
```

5. Enter show backup-network to view a list of backup files that have been created.
Verify that the **Created On** column displays an entry that has a time stamp that is approximate to the time you started the backup.

FIGURE 132 Enter the show backup-network command

```
cb172651# show backup-network  
No.    Created on                Patch Version             File Size  
-----  
1      2013-10-23 11:01:14 GMT   2.5.0.0.402              1.2K  
2      2013-10-24 02:40:22 GMT   2.5.0.0.402              1.2K
```

6. Enter copy backup-network {ftp-url}, where {ftp-url} (remove the braces) is the URL or IP address of the FTP server to which you want to back up the cluster configuration.
The CLI prompts you to choose the number that corresponds to the backup file that you want to export to the FTP server.

- Enter the number of the backup file that you want to export to the FTP server.

The controller encrypts the backup file, and then exports it to the FTP server. When the export process is complete, the following message appears on the CLI:

Succeed to copy to remote FTP server Successful operation

FIGURE 133 Succeed to copy to remote FTP server indicates that you have exported the backup file to the FTP server successfully

```
cb172651# copy backup-network ftp://david-ko:AAAAa123@10.2.2.162
No.    Created on          Patch Version        File Size
-----
  1    2013-10-23 11:01:14 GMT  2.5.0.0.402         1.2K
  2    2013-10-24 02:40:22 GMT  2.5.0.0.402         1.2K

Please choose a backup to send to remote FTP server or 'No' to cancel: 2
Starting to copy the chosen backup to remote FTP server...
Starting to encrypt backup file...
Succeed to copy to remote FTP server
Successful operation
```

- Using an FTP client, log on to the FTP server, and then verify that the backup file exists.

The file format of the backup file is `network_<YYYYMMDDHHmmss>_<controller-version>.bak`.

For example, if you created the backup file on October 24th 2013 at 02:40:22 and the controller version is 2.5.0.0.402, you should see a file named `network_20131024024022_2.5.0.0.402.bak` on the FTP server.

You have completed backing up the controller to an FTP server.

Restoring from an FTP Server

Before you continue, take note of the following limitations with restoring a backup file of the controller network configuration from an FTP server:

- Only release 2.1 and later support restoring from an FTP server.
- In this current release, restoring the entire cluster from an FTP server is unsupported. The restore process must be performed on one node at a time.
- Restoring from an FTP server can only be performed using the CLI.



CAUTION

Restoring a backup file to the controller requires restarting all of the controller services.

Follow these steps to restore a backup file of the controller's network configuration that you previously uploaded to an FTP back to the controller.

- Log on to the controller from the CLI. For more information, see the corresponding *Command Line Interface Reference Guide* for your controller platform.
- At the prompt, enter `en` to enable privileged mode.

FIGURE 134 Enable privileged mode

```
cb172651> en
Password: *****
```

3. Enter `show cluster-state` to display the statuses of the node and the cluster.
Before continuing to the next step, verify that both the node and the cluster are in service.

FIGURE 135 Verify that both the node and the cluster are in service

```
cb172651# show cluster-state
Current Node Status : In service
Cluster Status      : In service
Cluster Operation   : None
System Mode         : None
```

4. Enter the following command to log on to the FTP server and check for available backup files that can be copied to the controller:
`copy <ftp-url> backup-network`
5. If multiple backup files exist on the FTP server, the **CLI** prompts you to select the number that corresponds to the file that you want to copy back to the controller.
If a single backup file exists, the **CLI** prompts you to confirm that you want to copy the existing backup file to the controller.
When the controller finishes copying the selected backup file from the FTP server back to the controller, the following message appears: `Succeed to copy the chosen file from the remote FTP server`
6. Enter `show backup-network` to verify that the backup file was copied back to the controller successfully.

FIGURE 136 Verify that the backup file was copied to the controller successfully

```
cb172651# copy ftp://david-ko:AAAAaa123@10.2.2.162 backup-network
Only one NetworkBackup file (network_20131024024022_2.5.0.0.402.bak) is found. Do you want to copy (or input 'no' to cancel)? [yes/no] yes
Starting to copy the chosen NetworkBackup file (network_20131024024022_2.5.0.0.402.bak) from remote FTP server...
Succeed to copy the chosen file from remote FTP server

cb172651# show backup-network
No.   Created on          Patch Version      File Size
-----
1     2013-10-24 02:40:22 GMT  2.5.0.0.402      1.2K
```

7. Run `restore network` to start restoring the contents of the backup file to the current controller.
The **CLI** displays a list of backup files, and then prompts you to select the backup file that you want to restore to the controller.

8. Enter the number that corresponds to the backup file that you want to restore.

FIGURE 137 Enter the number that corresponds to the backup file that you want to restore

```

cbl72651# restore network
-----
No.   Created on          Patch Version      File Size
-----
1     2013-10-24 02:40:22 GMT  2.5.0.0.402      1.2K
-----

Please choose a backup to restore or 'No' to cancel: 1
The matched network setting for current system serial number is found from the chosen backup as below:

[Control Plane Interfaces]
Interface  IP Mode  IP Address      Subnet Mask      Gateway
-----
Control    Dhcp
Cluster    Dhcp
Managemen  Dhcp
t

Default Gateway Interface : Management
Primary DNS Server       : 172.17.17.16
Secondary DNS Server     :
Internal Subnet Prefix   : 10.254.1

[Control Plane User Defined Interfaces]
Name      IP Address      Subnet Mask      Gateway          VLAN  Interface  Service
-----
v100     172.17.26.103   255.255.255.0   172.17.26.1     100   Control    Hotspot
v102     172.17.26.102   255.255.255.0   172.17.26.1     102   Control    Hotspot
v101     172.17.26.101   255.255.255.0   172.17.26.1     101   Managemen  Hotspot
t

Please confirm this network setting, and this action will restart all services that will cause current SSH connection closed. Do you want to continue (or input 'no' to cancel)? [yes/no] yes
Not all services are healthy. Do you want to continue (or input 'no' to cancel)? [yes/no] yes
Process had been started before and running...
Starting to stop all SCG services...

```

The CLI displays the network configuration that the selected backup file contains.

If the serial number of the current controller matches the serial number contained in one of the backup files, the CLI automatically selects the backup file to restore and displays the network configuration that it contains.

9. Type **yes** to confirm that you want to restore the selected backup file. The controller starts the restore process and performs the following steps:
 - a) Stop all services.
 - b) Back up the current network configuration.

This will enable the controller to roll back to the current configuration, in case there is an issue with the restore process.
 - c) Clean up the current network configuration.

The controller deletes its previous network configuration, including static routes, name server, user defined interfaces, etc.

10. Restore the network configuration contained in the selected backup file.

Administering the Controller

Backing Up and Restoring Clusters

11. Restart all services.

When the restore process is complete, the following message appears on the CLI: All services are up!

FIGURE 138 The controller performs several steps to restore the backup file

```
cb172b51# restore network
Process had been started before and running...
Starting to stop all SCG services...
Checking action...Done!
Checking type...Done!
Checking creator...Done!
Checking reason...Done!
service stop flag file already exists, skip create it
07:20:24.342 [main] INFO c.ruckuswireless.wsg_cluster.Cluster - Load cluster environment file [/opt/ruckuswireless/wsg/conf/configurableSetting.properties]
wait for (CaptivePortal,Cassandra,Communicator,Configurer,EventReader,Greyhound,Memcached,Northbound,Scheduler,SubscriberManagement) Down!
wait for (Cassandra,Communicator,Configurer,Memcached) Down!
wait for (Cassandra,Configurer,Memcached) Down!
wait for (Cassandra,Configurer,Memcached) Down!
wait for (Cassandra,Configurer,Memcached) Down!
wait for (Cassandra,Configurer,Memcached) Down!
wait for (Cassandra,Configurer,Memcached) Down!
wait for (Configurer) Down!
All services are down!
Stop service SCG done!
Starting to restore current system network setting...
Starting to backup current network settings for rollback
Starting to restore network configuration
Starting to delete the routes of control plane
Starting to delete the user interfaces of control plane
Starting to update the IP settings of control plane
Starting to update the DNS of control plane
Starting to update the internal subnet of control plane
Restarting control plane network
Starting to update the user interfaces of control plane
Restarting control plane network
Succeed to restore network configuration
Starting to start all SCG services...
Checking action...Done!
Checking type...Done!
Checking creator...Done!
Checking reason...Done!
service start flag file already exists, skip create it
wait for (CaptivePortal,Cassandra,Communicator,EventReader,Greyhound,Memcached,Monitor,Northbound,Scheduler,SubscriberManagement,SubscriberPortal,Web) Up!
wait for (CaptivePortal,Communicator,EventReader,Greyhound,Memcached,Monitor,Northbound,Scheduler,SubscriberManagement,SubscriberPortal,Web) Up!
wait for (CaptivePortal,Communicator,EventReader,Greyhound,Memcached,Monitor,Northbound,Scheduler,SubscriberManagement,SubscriberPortal,Web) Up!
wait for (Communicator,EventReader,Greyhound,Monitor,Northbound,Scheduler,SubscriberManagement) Up!
wait for (Monitor) Up!
wait for (Monitor) Up!
wait for (Monitor) Up!
All services are up!
```

12. Do the following to verify that the restore process was completed successfully:
 - a) Run show cluster-state to verify that the node and the cluster are back in service.
 - b) Run show interface to verify that all of the network configuration settings have been restored.

FIGURE 139 Verify that the node and cluster are back in service and that the network configuration has been restored successfully

```
cb172651# show cluster-state
Current Node Status : In service
Cluster Status      : In service
Cluster Operation   : None
System Mode         : None

cb172651# show interface
Interfaces
-----
Interface   : Control
IP Mode     : Dhcp
IP Address  : 10.2.7.155
Subnet Mask : 255.255.0.0
Gateway    : 10.2.0.1

Interface   : Cluster
IP Mode     : Dhcp
IP Address  : 10.2.2.215
Subnet Mask : 255.255.0.0
Gateway    : 10.2.0.1

Interface   : Management
IP Mode     : Dhcp
IP Address  : 172.17.26.51
Subnet Mask : 255.255.254.0
Gateway    : 172.17.26.1

Default Gateway Interface : Management
Primary DNS Server       : 172.17.17.16
Secondary DNS Server     :

User Defined Interfaces
-----
IP Address      : 172.17.26.101
Subnet Mask     : 255.255.255.0
Gateway        : 172.17.26.1
VLAN           : 101
Physical Interface : Management
Service        : Hotspot

IP Address      : 172.17.26.103
Subnet Mask     : 255.255.255.0
Gateway        :
VLAN           : 100
Physical Interface : Control
```

You have completed importing and applying the network configuration backup from the FTP server to the controller.

Backing up Cluster Configuration

Ruckus Wireless® strongly recommends that you back up the controller database periodically. This will help ensure that you can restore the system configuration settings easily if the database becomes corrupted for any reason.

The following are backed up in the system configuration backup file:

TABLE 38 Contents of a cluster configuration backup file

Configuration Data	Administration Data	Report Data	Identity Data
AP zones	Cluster backup	Saved reports	Created profiles
Third-party AP zones	System configuration backups	Historical client statistics	Generated guest passes
Services and profiles	Upgrade settings and history	Network tunnel statistics	
Packages	Uploaded system diagnostic scripts		
System settings	Installed licenses		
Management domains			
Administrator accounts			
MVNO accounts			

A system configuration backup does not include control plane settings, data plane settings, and user-defined interface settings.

1. Go to **Administration > Backup and Restore**.
2. Select the **Configuration** tab.
3. In System Configuration Backup History, click **Backup**.

The following confirmation message appears: Are you sure you want to back up the controller's configuration?

4. Click **Yes**.

A progress bar appears as the controller creates a backup of its database. When the backup process is complete, the progress bar disappears, and the backup file appears under the **System Configuration Backup History** section.

Scheduling a Configuration Backup

1. Go to **Administration > Backup and Restore**.
2. Select the **Configuration** tab.
3. In Schedule Backup, you can configure the controller to backup its configuration automatically based on a schedule you specify.
 1. In Schedule Backup, click **Enable**.
 2. In Interval, set the schedule when the controller will automatically create a backup of its configuration. Options include: Daily, Weekly and Monthly.
 3. Hour: Select the hour of the day when the controller must generate the backup.
 4. Minute: Select the minute of the hour.
 5. Click **OK**.

You have completed configuring the controller to create a backup automatically.

Exporting the Configuration Backup to an FTP Server Automatically

In addition to backing up the configuration file manually, you can configure the controller to export the configuration file to an FTP server automatically whenever you click **Backup**.

Follow these steps to back up the configuration file to an FTP server automatically.

1. Go to **Administration > Backup and Restore**.
2. Select the **Configuration** tab.
3. In Auto Export Backup, you can configure the controller to export the configuration file to an FTP server automatically whenever you back up the configuration file.
 1. In Auto Export Backup, click **Enable**.
 2. FTP Server: Select the FTP server to which you want to export the backup file.
 3. Click **Test**. The controller attempts to establish connection to the FTP server using the user name and password that you supplied. If the connection attempt is successful, a success message is displayed. If the connection attempt is unsuccessful, verify that the FTP server details (including the user name and password) are correct, and then click **Test** again.
 4. Click **OK**.
4. After you verify the controller is able to connect to the FTP server successfully, click **OK** to save the FTP server settings.

You have completed configuring the controller to export the configuration backup file to an FTP server.

Downloading a Copy of the Configuration Backup

After you create a configuration backup, you have the option to download the backup file from the **System Configuration Backups History** section.

1. Go to **Administration > Backup and Restore**.
2. Select the **Configuration** tab.
3. Locate the entry for the backup file that you want to download. If multiple backup files appear on the list, use the date when you created the backup to find the backup entry that you want.
4. Click **Download**.

Your web browser downloads the backup file to its default download folder. NOTE: When your web browser completes downloading the backup file, you may see a notification at the bottom of the page.

5. Check the default download folder for your web browser and look for a file that resembles the following naming convention:
{Cluster Name}_BackupConf_{MMdd}_db_{MM}_{dd}_{HH}_{mm}.bak

For example, if the controller cluster is named Cluster A and you created the configuration backup on September 7 at 11:08 AM, the backup file name will be: **ClusterA_BackupConf_0907_db_09_07_11_08.bak**

You have completed downloading a copy of the configuration backup.

Restoring a System Configuration Backup

In the event of a failure or emergency where you may need to go back to the previous version of a cluster, you will have to restore your system configuration backup and restart the cluster.

1. Go to **Administration > Backup and Restore**.
2. Select the **Configuration** tab.

3. Once you locate the backup file, click **Restore** that is in the same row as the backup file. A confirmation message appears.

NOTE

Take note of the backup version that you are using. At the end of this procedure, you will use the backup version to verify that the restore process was completed successfully.

4. Click **Yes**. The following message appears: `System is restoring. Please wait...` When the restore process is complete, the controller logs you off the web interface automatically.
5. Log on to the controller web interface.
Check the web interface pages and verify that the setting and data contained in the backup file have been restored successfully to the controller.

You have completed restoring a system configuration backup file.

Upgrading the Controller

Ruckus Wireless may periodically release controller software updates that contain new features, enhancements, and fixes for known issues. These software updates may be made available on the Ruckus Wireless support website or released through authorized channels.



CAUTION

Although the software upgrade process has been designed to preserve all controller settings, Ruckus Wireless strongly recommends that you back up the controller cluster before performing an upgrade. Having a cluster backup will ensure that you can easily restore the controller system if the upgrade process fails for any reason.



CAUTION

Ruckus Wireless strongly recommends that you ensure that all interface cables are intact during the upgrade procedure.



CAUTION

Ruckus Wireless strongly recommends that you ensure that the power supply is not disrupted during the upgrade procedure.

If you are managing a SCG200 controller, you can also perform system configuration backup, restore, and upgrade from the controller command line interface.

Performing the Upgrade

Ruckus Wireless® strongly recommends backing up the controller cluster before performing the upgrade. If the upgrade process fails for any reason, you can use the latest backup file to restore the controller cluster.

Before starting this procedure, you should have already obtained a valid controller software upgrade file from Ruckus Wireless® Support or an authorized reseller.

Always back up the controller before attempting a software upgrade. If you are managing a multi-node cluster, back up the entire cluster, and then verify that the backup process completes successfully.

If you have an FTP server, back up the entire cluster and upload the backup files from all the nodes in a cluster to a remote FTP server.

1. Copy the software upgrade file that you received from Ruckus Wireless® to the computer where you are accessing the controller web interface or to any location on the network that is accessible from the web interface.
2. Go to **Administration > Upgrade**.

3. Select the **Upgrade** tab.

In Current System Information, the controller version information displayed.

NOTE

The **Upgrade History** tab displays information about previous cluster upgrades.

4. In Upload, select the **Run Pre-Upgrade Validations** check box to verify if the data migration was successful. This option allows you to verify data migration errors before performing the upgrade.
5. Click **Browse** to select the patch file.
6. Click **Upload** to upload the controller configuration to the one in the patch file.

The controller uploads the file to its database, and then performs file verification. After the file is verified, the **Patch for Pending Upgrade** section is populated with information about the upgrade file. If data migration was unsuccessful, the following error is displayed: `Exception occurred during the validation of data migration. Please apply the system configuration backup and contact system administrator.`

7. You can now:
 - Click **Upgrade** to start the upgrade process without backing up the current controller cluster or its system configuration, or
 - Click **Backup & Upgrade** to back up the controller cluster and system configuration before performing the upgrade.

When the upgrade (or backup-and-upgrade) process is complete, the controller logs you off the web interface automatically. When the controller log on page appears again, you have completed upgrading the controller.

In the **Current System Information** section, check the value for controller version. If the firmware version is newer than the firmware version that controller was using before you started the upgrade process, then the upgrade process was completed successfully.

NOTE

APs periodically send scheduled configuration requests to the controller, including the firmware version. Therefore, when an AP joins a zone for the first time, the firmware version is verified by the controller. If the firmware version is different from that which is configured for the zone, the controller responds with a request to upgrade it, after which the AP initiates a request to upgrade the firmware using HTTP.

Uploading an AP Patch File

New AP models and firmware updates are supported without the need to upgrade the controller image by using the AP patch files supplied by Ruckus Wireless.

1. Go to **Administration > Upgrade**.
2. Select the **AP Patch** tab.
3. In Patch File Upload, click **Browse** to select the patch file (with extension .patch).
4. Click **Open**.
5. Click **Upload**. The upload status bar is displayed, and after the patch file is uploaded, the section is populated with the patch filename, size, firmware version, and supporting AP models.
6. Click **Apply Patch**. The apply patch status bar is displayed.

After the patch file is updated, you will be prompted to log out.

When you login again, the **AP Patch History** section displays information about the patch file such as start time, AP firmware and model.

You have successfully updated the AP models and AP firmware with the patch file, without having to upgrade the controller software.

Verifying the Upgrade

You can verify that the controller upgrade was completed successfully.

1. Go to **Administration > Upgrade**.
2. In the **Current System Information** section, check the value for *Controller Version*. If the firmware version is newer than the firmware version that controller was using before you started the upgrade process, then the upgrade process was completed successfully.

NOTE

APs periodically send scheduled configuration requests to the controller, including the firmware version. Therefore, when an AP joins a zone for the first time, the firmware version is verified by the controller. If the firmware version is different from that which is configured for the zone, the controller responds with a request to upgrade it, after which the AP initiates a request to upgrade the firmware using HTTP.

Rolling Back to a Previous Software Version

There are scenarios in which you may want to roll back the controller software to a previous version.

Here are two:

- You encounter issues during the software upgrade process and the controller cannot be upgraded successfully. In this scenario, you can only perform the software rollback from the CLI using the `restore local` command. If you have a two-node controller cluster, run the `restore local` command on each of the nodes to restore them to the previous software before attempting to upgrade them again.
- You prefer a previous software version to the newer version to which you have upgraded successfully. For example, you feel that the controller does not operate normally after you upgraded to the newer version and you want to restore the previous software version, which was more stable. In this scenario, you can perform the software rollback either from the web interface or the CLI. If you have a two-node controller cluster, you must have cluster backup on both of the nodes.

To ensure that you will be able to roll back to a previous version, Ruckus Wireless® strongly recommends the following before attempting to upgrade the controller software:

- Always back up the controller before attempting a software upgrade. If you are managing a multi-node cluster, back up the entire cluster, and then verify that the backup process completes successfully. See [Creating a Cluster Backup](#) on page 275 for the local backup instructions. If you have a local backup and you want to roll back the controller to a previous software version, follow the same procedure described in [Creating a Cluster Backup](#) on page 275.
- If you have an FTP server, back up the entire cluster and upload the backup files from all the nodes in a cluster to a remote FTP server. See [Backing Up to an FTP Server](#) on page 277 for remote backup instructions and [Restoring from an FTP Server](#) on page 279 for remote restore instructions.

Upgrading the Data Plane

You can view and upgrade the virtual data plane version using patch files. This feature is only applicable for vSZ-H and vSZ-E.

1. Go to **Administration > Upgrade**.

2. Select the **DP Patch** tab.

The **DP Patch** page appears.

FIGURE 140 DP Patch - Virtual Data Plane Upgrade

3. In **Patch File Upload**, click **Browse** to select the patch file (.ximg file).
4. Click **Upload**. The patch files is uploaded.

The controller uploads the file to its database, and then performs file verification. After the file is verified, the **Patch for Pending Upgrade** section is populated with information about the upgrade file.

The following details are displayed:

- Patch File Name: Displays the name of the patch file.
- Patch File Size: Displays the size of the patch file.
- Patch Version: Displays the version of the patch file.

5. In **Data Planes**, identify the virtual data plane you want to upgrade, and then choose a patch file version from **Select upgrade version**.
6. Click **Apply** to apply the patch file version to the virtual data plane.

The following information about the virtual data plane is displayed after the patch file upgrade is completed.

- Name: Displays the name of the virtual data plane.
- DP MAC Address: Displays the MAC IP address of the data plane.
- Firmware: Displays the version of the data plane that has been upgraded.
- Registration State: This field displays whether all licenses pertaining to the data plane are approved.
- Upgrade Status: Displays the completion status of the patch file upgrade for the virtual data plane.

You have successfully upgraded the virtual data plane.

Managing Licenses

Depending on the number of Ruckus Wireless APs that you need to manage with the controller, you may need to upgrade the controller license as your network expands.

The maximum number of access points that the controller can manage is controlled by the license file that came with the controller. If the number of access points on the network exceeds the limit in the license file, you will need to obtain an additional license file and upload it to the controller.

NOTE

For information on obtaining additional license files, contact Ruckus Wireless Support or an authorized Ruckus Wireless reseller.

The maximum number of access points that a license supports depends on its stock-keeping unit (SKU).

Viewing Installed Licenses

You can synchronizing the license data, import a license file into the controller if it is unable to connect to the Ruckus Wireless SmartLicense system and release licenses bound to an offline controller by downloading a copy of the licenses.

1. Go to **Administration > Licenses**.
2. Select the **Installed Licenses** tab.

You can view the following information about the licenses you have uploaded to the controller:

- Name: The name of the node to which the license was uploaded
- Node: Displays the name of the node
- Start Date: The date when the license file was activated.
- End Date: For time-bound licenses, this column shows the date when the license file expires.
- Capacity: The number of units or license seats that the license file provides.
- Description: The type of license.

Importing Installed Licenses

If the controller is disconnected from the Internet or is otherwise unable to communicate with the Ruckus Wireless SmartLicense system (due to firewall policies, etc.), you can manually import a license entitlement file into the controller.

NOTE

The option to import a license file manually into the controller is only available if the controller is using the cloud license server.

1. Obtain the license file. You can do this by logging on to your Ruckus Wireless Support account, going to the license management page, and then downloading the license file (the license file is in .bin format).
2. Log on to the controller web interface, and then go to **Administration > Licenses**.
3. Select the **Installed Licenses** tab.
4. Select the node for which you are uploading the license file and click **Upload**.

The **Upload License** page appears where you must provide the following information:

- Select Controller: Select the node for which you are uploading the license file.
- Select License File: Click **Browse**, locate the license file (.bin file) that you downloaded from your Ruckus Wireless Support account, and then select it.

The page refreshes, and the information displayed changes to reflect the updated information imported from the SmartLicense platform.

Synchronizing Controller with the License Server

By default, the controller automatically synchronizes its license data with the selected license server every 24 hours. If you made changes to the controller licenses (for example, you purchased additional licenses) and you want the controller to download the updated license data immediately, you can trigger a manual synchronization.

1. Log on to the controller web interface, and then go to **Administration > Licenses**.
2. Select the **Installed Licenses** tab.
3. Click **Sync Now**.

When the sync process is complete, the message `Sync license with the license server successful` appears. If the previously saved license data are different the latest license data on the server, the information in the Installed Licenses section refreshes to reflect the latest data.

You have completed manually synchronizing the controller with the license server.

Downloading License Files

If you need to release licenses bound to an offline controller and allow those licenses to be used elsewhere (on a different controller), you can download a copy of the controller licenses. The option to download a copy of the controller licenses is only available if the controller is using the Ruckus Wireless cloud license server.

1. Log on to the controller web interface, and then go to **Administration > Licenses**.
2. Select the **Installed Licenses** tab.
3. Click **Download**.

The **Download License** page appears. In **Select Controller**, select the controller node for which you want to download the license files.

NOTE

You can upload and download license files only if the controller is using the Ruckus Wireless cloud license server.

4. Click **Download**. Your web browser downloads the license files from the controller.
5. When the download is complete, go to the default download folder that you have configured for your web browser, and then verify that the binary copy of the license files (with .bin extension) exists.

You have completed downloading copies of the controller licenses.

BSD 3-Clause for New and Revised Licenses

A permissive license similar to the BSD 2-Clause License, but with a 3rd clause that prohibits others from using the name of the project or its contributors to promote derived products without written consent.

Copyright (c) 2005, Google Inc. All rights reserved.

Redistribution and use in source and binary forms, with or without modification, are permitted provided that the following conditions are met:

- * Redistributions of source code must retain the above copyright notice, this list of conditions and the following disclaimer.
- * Redistributions in binary form must reproduce the above copyright notice, this list of conditions and the following disclaimer in the documentation and/or other materials provided with the distribution.

- * Neither the name of Google Inc. nor the names of its contributors may be used to endorse or promote products derived from this software without specific prior written permission.

ATTENTION

THIS SOFTWARE IS PROVIDED BY THE COPYRIGHT HOLDERS AND CONTRIBUTORS "AS IS" AND ANY EXPRESS OR IMPLIED WARRANTIES, INCLUDING, BUT NOT LIMITED TO, THE IMPLIED WARRANTIES OF MERCHANTABILITY AND FITNESS FOR A PARTICULAR PURPOSE ARE DISCLAIMED. IN NO EVENT SHALL THE COPYRIGHT OWNER OR CONTRIBUTORS BE LIABLE FOR ANY DIRECT, INDIRECT, INCIDENTAL, SPECIAL, EXEMPLARY, OR CONSEQUENTIAL DAMAGES (INCLUDING, BUT NOT LIMITED TO, PROCUREMENT OF SUBSTITUTE GOODS OR SERVICES; LOSS OF USE, DATA, OR PROFITS; OR BUSINESS INTERRUPTION) HOWEVER CAUSED AND ON ANY THEORY OF LIABILITY, WHETHER IN CONTRACT, STRICT LIABILITY, OR TORT (INCLUDING NEGLIGENCE OR OTHERWISE) ARISING IN ANY WAY OUT OF THE USE OF THIS SOFTWARE, EVEN IF ADVISED OF THE POSSIBILITY OF SUCH DAMAGE.

Configuring the License Server

Ruckus Wireless provides two options for managing the licenses that you have purchased for the controller - Cloud License Server and Local License Server (LLS).

Cloud License Server also known as the SmartLicense server, this a cloud-based server that stores all of the licenses and support entitlements that you have purchased for the controller. For information on how to set up and activate your SmartLicense account, see the SmartLicense User Guide.

1. Go to **Administration > Licenses**.
2. Select the **License Server** tab.
The Server details and Synchronization history are displayed.
3. Click **Configure**.
The **License Server Configuration** page appears.
 - Cloud License Server: Select this option to use the Ruckus Wireless SmartLicense server.
 - Local License Server: Select this option to use an LLS that you have set up on the network, and then configure
 - Domain or IP: Type the FQDN or IP address of the LLS.
 - Port: Type the port number. Port range is from 0 to 65535 (default is 3333).
4. Click **OK**.
5. Click **Sync Now** and the controller saves the selected license server configuration, deletes all of its saved license data, and then automatically synchronizing the license information with the selected license server.

You have completed configuring the license server that the controller will use.

Configuring License Bandwidth

You can assign a license bandwidth for a virtual data plane provided it is already approved. Each virtual data plane can be configured with only one bandwidth license. This feature is only applicable to vSZ-H and vSZ-E.

1. Go to **Administration > Licenses**.

2. Select the **License Bandwidth Configuration** tab.
The **License Bandwidth Configuration** page appears.

FIGURE 141 License Bandwidth Configuration

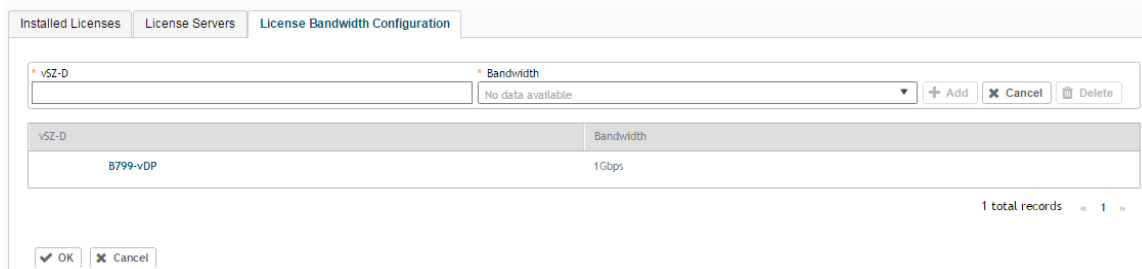

3. In **vSZ-D**, type the name of the virtual data plane.
4. From the **Bandwidth** drop-down menu, select the license bandwidth you want to assign to the virtual data plane.
5. Click **Add**. The vSZ-D with the assigned license bandwidth is displayed.
6. Click **OK**.

You have successfully assigned a license bandwidth to the virtual data plane.

ZoneDirector to SmartZone Migration

SmartZone controllers are better equipped to handle large WiFi deployments such as within campuses and when customers are vastly distributed; therefore, Ruckus Wireless recommends that you migrate existing ZoneDirector deployments to SmartZone controller deployments. You can migrate ZoneDirector AP configuration information to SmartZone controllers from the controller itself, using a migration tool.

The AP models should be supported by the controller.

NOTE

Only ZD versions 9.13, 9.13.1, 9.13.2 and 9.13.3 are supported.

1. Go to **Administration > ZD Migration**.
The **ZoneDirector Migration** page appears.
2. Configure the following:
 1. **ZoneDirector IP Address**: Type the IP address of the ZD that you want to migrate.
 2. **Admin Credentials**: Enter the username and password details to access/login to ZD.
 3. Click **Connect**. Lists of APs connected to the ZD deployment are displayed.
 4. Click **Select AP** to choose the AP information that you want to migrate from ZD.
 5. Click **Migrate** to migrate the AP. The controller imports the ZD configuration and applies it to the selected AP.

The **ZoneDirector Migration Status** section displays the status of the migration. When completed successfully, a success message is displayed. If migration fails, a failure message is displayed and you can attempt the migration process again.

Monitoring Administrator Activities

The controller keeps a record of all actions and configuration changes that administrators perform on the server. This feature enables you and other administrators in the organization to determine what changes were made to the controller and by whom.

1. Go to **Administration > Admin Activities**.
2. Select the **Admin Activities** tab. the **Admin Activities** page displays the administrator actions.

The following information is displayed:

- **Date and Time:** Date and time when the alarm was triggered
- **Administrator:** Name of the administrator who performed the action
- **Managed By:** Displays the system that manages the admin activities.
- **Source IP:** Displays the IP address of the device from which the administrator manages the controller.
- **Browser IP:** IP address of the browser that the administrator used to log on to the controller.
- **Action:** Action performed by the administrator.
- **Resource:** Target of the action performed by the administrator. For example, if the action is Create and the object is Hotspot Service, this means that the administrator created a new hotspot service.
- **Description:** Displays additional details about the action. For example, if the administrator created a new hotspot service, this column may show the following: **Hotspot [company_hotspot]** .



Click  to export the administrator activity list to a CSV file. You can view the default download folder of your web browser to see the CSV file named **clients.csv**. Use a spreadsheet application (for example, Microsoft® Excel®) to view the contents of the CSV file.

Managing Mobile Virtual Network Operator (MVNO) Accounts

A Mobile Virtual Network Operator (MVNO) uses a host carrier network to service its mobile users. An MVNO account is created for each operator and the MVNO page lists the accounts that are created.

1. Go to **Administration > MVNO**.
The **MVNO** page appears displaying information about MVNO accounts created.
2. Click **Create** to create an MVNO account.
The **The Mobile Virtual Network Operator** page appears.

3. Configure the following:
 1. The Mobile Virtual Network Operator Summary
 - a. Domain Name: Type a domain name to which this account will be assigned
 - b. Description: Type a brief description about this domain name.
 2. AP Zones of Mobile Virtual Network Operator: Displays the AP zones that are allocated to this MVNO account
 - a. Click **Add AP Zone**. The **Add AP Zone** page appears.
 - b. AP Zone: Select the AP zone you want to add to the MVNO account from the drop-down menu.
 - c. Click **OK**.

NOTE

You can only select a single AP zone at a time. If you want to grant the MVNO account management privileges to multiple AP zones, select them one at a time.

3. WLAN Services: Configure the WLAN services to which the MVNO account that you are creating will have management privileges.
 - a. Click **Add WLAN**. The **Add WLAN** page appears.
 - b. SSID: Select the WLAN to which the MVNO account will have management privileges.

NOTE

You can only select one WLAN service at a time. If you want to grant the MVNO account management privileges to multiple WLAN service zones, select them one at a time.

- c. Click **OK**.

4. Super Administrator: Configure and define the logon details and management capabilities that will be assigned to the account.
 - a. Account Name: Type the name that this MVNO will use to log on to the controller.
 - b. Real Name: Type the actual name (for example, John Smith) of the MVNO.
 - c. Password: Type the password that this MVNO will use (in conjunction with the Account Name) to log on to the controller.
 - d. Confirm Password: Type the same password as above. f) In Phone, type the phone number of this MVNO.
 - e. Phone: Type the phone number of the administrator.
 - f. Email: Type the email address of this MVNO.
 - g. Job Title: Type the job title or position of this MVNO in his organization.
5. RADIUS Server for Administrator Authorization and Authentication: See [Creating a RADIUS Server for Administrator Authentication](#) on page 273 for more information.

4. Click **OK**.

You have created an MVNO account.

NOTE

You can also edit and delete the account by selecting the options **Configure**, and **Delete** respectively, from the **MVNO** page.

Managing Events and Alarms

- Viewing Events..... 297
- Sending SNMP Traps and Email Notifications for Events..... 297
- Configuring Event Threshold.....298
- Configuring Alarms..... 299

Viewing Events

An event is an occurrence or the detection of certain conditions in and around the network. An AP being rebooted, an AP changing its IP address, and a user updating an AP's configuration are all examples of events.

Go to **Events and Alarms > Events**.

The **Events** page appears displaying the following information:

You can also click the  icon to apply filters, to display events based on time and severity.

- Date and Time: Displays the date and time when the event occurred
- Code: Displays the event code (see the Alarm and Event Reference Guide for your controller platform more information).
- Type: Displays the type of event that occurred (for example, AP configuration updated).
- Severity: Displays the severity level assigned to the events such as Critical, Debug, Informational, Warning, Major etc.
- Activity: Displays additional details about the event, including (if available) the specific access point, control plane, or data plane that triggered the event.

NOTE

Click  to export the event details to a CSV file. Check the default download folder of your web browser and look for a file named *events.csv* and view it using a spreadsheet application (for example, Microsoft Excel®).

Sending SNMP Traps and Email Notifications for Events

By default, the controller saves a record of all events that occur to its database. You can configure the controller to also send SNMP traps and email notifications for specific events whenever they occur.

Verify that global SNMP traps are enabled to ensure that the controller can send SNMP traps for alarms.

You can also manually trigger SNMP traps without generating events using CLI. You can use the **#trigger-trap <event code>** command to trigger traps for respective events with their default attributes.

You can acquire the status of a specific client MAC address by using the query RUCKUS-CTRL-MIB. For more information, see the *SmartZone SNMP MIB Reference Guide*.

1. Go to **Events and Alarms > Events**.

2. Click the **Event Management** tab.

The **Event Management** page appears displaying the following information:

- **Email Notification:** Select the **Enable** check box, and then type an email address or email addresses in the **Mail To** box. If you want to send notifications to multiple recipients, use a comma to separate the email addresses. Then, click **OK**.
- **Events:** View the table and select the events for which you want to send traps or email notifications (or both). Select the **Enable** or **Disable** options from the drop-down menu, and configure the following:
 - **Enable SNMP Notification:** Click this link to enable SNMP trap notifications for all selected events.
 - **Enable Email:** Click this link to enable email notifications for all selected events.
 - **Enable DB Persistence:** Click this link to enable saving of all selected events to the controller database. If an event is already currently enabled, it will stay enabled after you click this link.

Configuring Event Threshold

An event threshold defines a set of conditions related to the controller hardware that need to be met before the controller triggers an event. You can accept the default threshold values or you can update the threshold values to make them more suitable to your deployment or controller environment.

1. Go to **Events and Alarms > Events**.
2. Click the **Event Threshold** tab.

This page displays the list of events with configurable thresholds including the event code, severity level, default value and accepted range, and unit of measurement for each event.

3. Identify the event threshold that you want to configure.
4. Click the event name under the **Name** column.

The threshold value for the event becomes editable. Next to the threshold value, the acceptable range is displayed.

5. Edit the threshold value.
6. Click **OK**.

Configuring Alarms

Alarms are a type of event that typically warrants your attention. Alarms are generated by managed access points and the controller system (control plane and data plane).

Go to **Events and Alarms > Alarms**.

The **Alarms** page appears displaying the following information:

- **Date and Time:** Displays the date and time when the alarm was triggered.
- **Code:** Displays the alarm code (see the Alarm and Reference Guide for your controller platform for more information).
- **Alarm Type:** Displays the type of alarm event that occurred (for example, AP reset to factory settings).
- **Severity:** Displays the severity level assigned to the events such as Critical, Major, Minor and Warning.
- **Status:** Indicates whether the alarm has already been cleared or still outstanding.
- **Activity:** Displays additional details about the alarm, including (if available) the specific access point, control plane, or data plane that triggered the alarm.
- **Acknowledged On:** Displays the date and time when the administrator acknowledged the alarm.
- **Cleared By:** Displays information about who cleared the alarm.
- **Cleared On:** Displays the date and time when the alarm was cleared.
- **Comments:** Displays administrator notes recorded during alarm management.

NOTE



Click  to export the alarms details to a CSV file. Check the default download folder of your web browser and look for a file named *alarms.csv* and view it using a spreadsheet application (for example, Microsoft Excel®).

Clearing Alarms

Clearing an alarm removes the alarm from the list but keeps it on the controller's database.

To clear an alarm:

1. Select the alarm from the list and click **Clear Alarm**. The **Clear Alarm** page appears.
2. Type your comments and select **Apply**.

Acknowledging Alarms

Acknowledging an alarm lets other administrators know that you have examined the alarm. After you acknowledge an alarm, it will remain on the list of alarms and will show the date and time that you acknowledged it.

To acknowledge an alarm:

1. Select the alarm from the list and click **Acknowledge Alarm**.

This message appears:

Are you sure you want to acknowledge the selected alarms?

.

2. Select **Yes**.

Applying Filters

You can view a list of alarms by date, time, severity and status.

1.

Click the  icon.

The **Apply Filters** page appears. Configure the following:

1. Severity: Select the severity level by which you want to filter the list of alarms.
2. Status: Select the status by which you want to filter the list of alarms.
3. Date and Time: Select the alarms by their start and end dates.

2. Click **OK**.

All the alarms that meet the filter criteria are displayed on the **Alarms** page and the display changes to **Filter On**.

You can export the alarms into a CSV file by clicking the  icon.

Diagnostics

- Applying Scripts..... 301
- Applying AP CLI Scripts..... 301
- Viewing and Downloading Logs.....302
- Viewing RADIUS Proxy Settings..... 304
- Viewing RADIUS Server Settings..... 304
- Viewing DHCP Relay Settings.....304

Applying Scripts

New AP models and firmware updates are supported without the need to upgrade the controller image by using AP patch files and diagnostic scripts.

1. Go to **Administration > Diagnostics > Scripts**.
2. Select the **Patch/Diagnostic Scripts** tab.
3. Select the **Upload to current node** check-box.
4. Click **Browse** to select a script that you want to upload to the controller.
5. Click **Upload**.

The script is listed in the **System Uploaded Scripts** section.

If you have uploaded a patch script, it is displayed in the **System Uploaded Patch Scripts** section with the following information:

- Name of the patch file
- Patch file description
- Supported AP firmware version
- AP model number

Click **Delete** to delete scripts.

6. Click **Apply Patch** to apply the patch file to the AP model or firmware as appropriate.

You have successfully applied scripts to the controller AP.

Applying AP CLI Scripts

New AP models and firmware updates are supported without the need to upgrade the controller image by using AP CLI scripts.

1. Go to **Administration > Diagnostics > Scripts**.
2. Select the **AP CLI Scripts** tab.
3. From **Select AP Zone**, choose the AP zone for which you want to apply the script.
4. Click **Browse** to select an AP CLI script that you want to upload.
5. Click **Upload**.

The script is listed in the **Script Execution Summary** section.

Click **Delete** to delete scripts.

6. Click **Execute** to apply the AP CLI script file to the AP zone.

You have successfully applied AP CLI scripts to the controller AP.

Viewing and Downloading Logs

The controller generates logs for all the applications that are running on the server.

1. Go to **Administration > Diagnostics > Application Logs**.

The **Application Logs** page appears.

2. From **Select the Control Plan**, select the control plane for which you want to download logs.
3. Select the **Upload to current node** check-box.
4. You can now opt to select:

Option	Description
Download Logs	To download all logs for the selected application.
Download All Logs	To download all available logs from the controller. Go to your web browsers default download location and verify that the TGZ file was downloaded successfully. You must use your preferred compression/decompression program to extract the log files from the TGZ file. When the log files are extracted (for example, <code>adminweb.log</code> , <code>cassandra.log</code> , <code>communicator.log</code> , etc.), use a text editor to open and view the log contents.
Download Snapshot Logs	To download snapshot logs that contain system and configuration information, such as the AP list, configurations settings, event list, communicator logs, SSH tunnel lists, etc. If you triggered the controller to generate a snapshot from the CLI, you have the option to download snapshot logs from the web interface. Go to your browser's default download folder, and then verify that the snapshot log file or files have been downloaded successfully. Extract the contents of the tar file.

You have successfully completed downloading log files/snapshot logs from the controller.

Available System Logs for SCG200, vSZ-H and SZ300

The controller generates logs for all the applications that are running on the server.

The following table lists the controller applications that are running.

TABLE 39 Controller applications and log types

Application	Description
AIP	Handles the accounting messages for TTG sessions
CaptivePortal	Performs portal redirect for clients and manages the walled garden and blacklist
Cassandra	The controller's database server that stores most of the run-time information and statistical data
CIP	The <code>Charging Interface</code> module, which handles the Ga interface towards CGF server
CNR	An application that obtains TTG configuration updates and applies the settings to related modules
Communicator	Communicates with access points and retrieves statuses, statistics, and configuration updates
Configurer	Performs configuration synchronization and cluster operations (for example, join, remove, upgrade, backup, and restore)
DHCPServer	The DHCP server in the SCG-C TTG module receives DHCP messages from DHCP relay in d-blade

TABLE 39 Controller applications and log types (continued)

Application	Description
DiaAuthProcess	Uses the sTta/Gx interface for authentication through the Diameter Protocol.
Diagnostics	An interface that can be use to upload Ruckus Wireless scripts (.ksp files) for troubleshooting or applying software patches. This interface displays the diagnostic scripts and system patch scripts that are uploaded to a node.
EAuth	Manages the sessions on the SCG-C TTG module
EventReader	Receives event messages from access points and saves the information into the database
Greyhound	The interface between the SCG-C TTG module and the AP interface, used to send and receive proprietary messages for AP association and disassociation
HIP	Module with SIGTRAN stack and interface to operator HLR(s)
LogMgr	Organizes the Application Logs into a common format, segregates them, and copies them into the respective Application log file
MdProxy	MdProxy on AP and SCG connect to AP-MD and SCG-MD respectively. MdProxy on SCG receives messages and retrieves the message header. It also forwards the response to SCG-MD. This message is sent to the MdProxy on AP through AP-MD. MdProxy on the AP removes the MSL header and responds to the connection on which the request was received.
Memcached	The controller's memory cache that stores client authentication information for fast authentication or roaming
MemProxy	Replicates MemCached entries to other cluster nodes
Monitor	Monitors the health of cluster processes and communicates cluster state changes to the cluster node
Mosquitto	A lightweight method used to carry out messaging between LBS and APs
Mqttclient	A lightweight client used to communicated with the MQTT server using methods that block intrusion until an operation completes.
MsgDist	The Message distributor (MD) maintains a list of communication points for both local applications and remote MDs to perform local and remote routing
NC	The Node Controller, which monitors all SCG-C TTG processes
NginX	Is a web server that is used as a reserve proxy server or a HTTP cache
Northbound	As an interface between SP and AAA, it performs UE authentication and handles approval or denial of UEs to AP.
OnlineSignup	A standard and secured method to access devices in a WPA2 hotspot network
PMIPv6d	Handles UE Session Context details for PMIP calls
RadiusProxy	Sets the RADIUS dispatch rules and synchronizes configuration to each cluster node
Scheduler	Performs task scheduling and aggregates statistical data
SNMP	Provides a framework for the monitoring devices on a network. The SNMP manager is the system is used to control and monitor the activities of network hosts using SNMP. As an agent that responds to queries from the SNMP Manager, SNMP Traps with relevant details are sent to the SNMP Manager when configured.
SubscriberManagement	Maintains local user credentials for WISPr authentication.
SubscriberPortal	Internal portal page for WISPr (hotspot)
System	Collects and sends log information from all processes
Web	Runs the controller management web server

Viewing RADIUS Proxy Settings

You must be aware of the RADIUS proxy settings on the controller to monitor the health of the controller.

Go to **Administration > Diagnostics > RADIUS**.

The **Proxy** page appears displaying the RADIUS settings.

FIGURE 142 Diagnostics - RADIUS Proxy

MVNO Account	Control Plane	AAA IP	Created On	Last Modified On	NAS Type	Auth	Accounting	ACCESS Request	ACC
--------------	---------------	--------	------------	------------------	----------	------	------------	----------------	-----

Viewing RADIUS Server Settings

You must be aware of the RADIUS server settings on the controller to monitor the health of the controller.

Go to **Administration > Diagnostics > RADIUS**.

The **Server** page appears displaying the RADIUS settings.

FIGURE 143 Diagnostics - RADIUS Server

MVNO Account	Control Plane	AAA IP	Created On	Last Modified On	NAS Type	Auth Type	Auth (Perm)	Auth (Psd)	Auth
Super	setup-1-C	182.168.11.6	2017/02/07 12:53:24	2017/03/01 15:23:11	Ruckus AP		0/0	0/0	0/0

1 total records << 1 >>

Viewing DHCP Relay Settings

You must be aware of the DHCP relay settings on the controller to monitor the health of the controller.

1. Go to **Administration > Diagnostics > DHCP**.

2. Select the **Relay** tab.

The **DHCP Relay** page appears displaying the settings.

FIGURE 144 Diagnostics - DHCP Relay

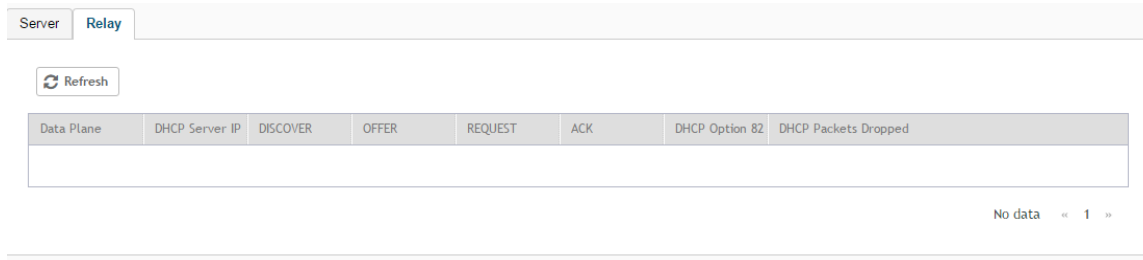

Statistics Files the Controller Exports to an FTP Server

If you added an FTP server to the controller, the controller will export statistics files to that FTP server, either on demand or based on a schedule. This is however only applicable for SCG200, SZ300 and vSZ-H.

NOTE

The feature to export CSV files is only supported in SCG200, SZ300, and vSZ-H platforms.

To enable this feature, go to the controller web UI and select the **Enable uploading statistical data to the FTP server** check-box from **System > General Settings > FTP**.

After the feature is enabled, each controller node sends a zip file to the FTP server via FTP or SFTP, on an hourly basis. The zip file is named as: `<directory_name> + '_' + <scg_node_identifier> + ".zip"`.

Here, `directory_name` is named as `yyyymmddhh` (indicating the beginning of the hour that the data was received). For example, the directory name for the data that comes between 10 and 11 AM of May 26, 2016, is **"2016052610"**.

The zip file contains all the reported data collected within the hour.

The data is divided into tables, and each data table is associated with files. The files are named as follows: `<Table Name> + '_' + <Thread_ID> + '_' + <Sequence_No>.csv`.

Here, `Table Name` is as described in [Table 40](#). `Thread_ID` is an integer, and `Sequence_No` is from 1 to N to limit each file to be capped around 1G bytes.

Each AP sends its statistic counters to the controller, every 180 seconds. The controller stores the data, and exports them as CSV files to the external FTP server, every hour. The controller stores the data for up to 6 hours; if the FTP server is down, the controller resends data for up to 6 hours.

TABLE 40 Exported CSV file table

Table Name	Table Description
APStatus	Root for all Status: Cluster, Domain, Zone info
APStatusSystem	AP Level Info
APStatusRadio	AP Radio Info
APStatusWlan	AP Wlan Info
APStatusTunnel	AP Tunnel Info
APStatusIPSec	AP IPSec Info
APStatusIPSecStats	AP IPSec stats
LanPortStatus	AP Lan Port Status
CertificateReload	AP Certificate Reload Info
CableModemInfo	Cable Modem inside AP
APStatusLBS	Location-Based Service
APStatusBrownout	AP Voltage Brownout Event
APReportStats	Root for all ReportCluster, Domain, Zone Info
APReportBin	Little Bin info
APReportBinRadio	Radio Stats

TABLE 40 Exported CSV file table (continued)

Table Name	Table Description
APReportBinWlan	Wlan Stats
APReportBinClient	Client Stats
APReportBinTunnel	Tunnel Stats
APReportBinIPSec	IPSec Stats
APClientStats	Root for all Client
APClientInfo	Client Stats
APClientRadio	Radio Static Info
APClientWlan	Wlan Static Info
APMeshStats	Root for all Mesh
APMeshDownlink	Mesh Downlink AP
APMeshUplink	Mesh Uplink AP
APMeshNeighbor	AP Mesh Neighbor
ArcMessage	Root for all AVC
FlowMessage	AVC Flow
RogueAPStats	Root for all Rogue
ReportType	Rogue Devices

Ports to Open for AP-SCG/SZ/vSZ/vSZ-D Communication

The table below lists the ports that must be opened in the network firewall to ensure that the SCG/vSZ-D/SZ/vSZ (controller), managed APs, and RADIUS servers can communicate with each other successfully.

TABLE 41 Ports to open for AP-SCG/SZ/vSZ/vSZ-D communication

Port Number	Layer 4 Protocol	From (Sender)	To (Listener)	Configurable from Web Interface?	Purpose
21	TCP	AP	vSZ control plane	Yes	FTP upload of reports, statistics, and configuration backups
22	TCP	<ul style="list-style-type: none"> AP vSZ-D 	vSZ control plane	No	SSH tunnel
49	TCP	TACACS+ server	vSZ control plane	Yes	TACACS+ based authentication of controller administrators
Port 91 (AP firmware version 2.0 to 3.1.x) and 11443 (AP firmware version 3.2 and later)	TCP	AP	vSZ control plane	No	<p>AP firmware upgrade</p> <p>NOTE Starting in release 3.2, the controller uses an HTTPS connection and an encrypted path for the firmware download. The port used for AP firmware downloads has also been changed from port 91 to 11443 to distinguish between the two methods. To ensure that all APs can be upgraded successfully to the new firmware, open both ports 11443 and 91 in the network firewall.</p>
9997	TCP	Client Device	SZ control Plane	No	Internal Subscriber Portal in HTTP protocol
443	TCP	<ul style="list-style-type: none"> AP vSZ-D 	vSZ control plane	No	Access to the SCG/vSZ/SZ control plane over secure HTTPS
6868	TCP	vSZ-D	vSZ	No	Internal communication port
8443	TCP	Any	vSZ management plane	No	Access to the SCG/vSZ/SZ web interface via HTTPS
					<p>NOTE The Public API port has changed from 7443 to 8443.</p>
23232	TCP	AP	SCG (data plane)	No	GRE tunnel

Ports to Open for AP-SCG/SZ/vSZ/vSZ-D Communication

TABLE 41 Ports to open for AP-SCG/SZ/vSZ/vSZ-D communication (continued)

Port Number	Layer 4 Protocol	From (Sender)	To (Listener)	Configurable from Web Interface?	Purpose
23233	UDP and TCP	AP	Data plane	Yes	GRE tunnel (required only when tunnel mode is GRE over UDP) NOTE On the vSZ-D, this port is used for both data and control in both UDP and TCP.
12222/12223	UDP	AP	vSZ control plane	No	LWAPP discovery NOTE If your AP is within the same subnet as the controller, disable nat-ip-translation to establish a connection between the AP and the controller so that AP firmware upgrade progresses. If your AP is on the side of the NAT server and if the NAT server does not support PASV-Mode FTP, enable nat-ip-translation. If the NAT server supports PASV-Mode FTP, then disable nat-ip-translation for AP firmware upgrade to progress
1812/1813	UDP	AP	Radius servers (s)	Yes	AAA authentication and accounting
8022	No (SSH)	Any	Management interface	Yes	When the management ACL is enabled, you must use port 8022 (instead of the default port 22) to log on to the CLI or to use SSH.
8090	TCP	Any	vSZ control plane	No	Allows unauthorized UEs to browse to an HTTP website
8099	TCP	Any	vSZ control plane	No	Allows unauthorized UEs to browse to an HTTPS website
8100	TCP	Any	vSZ control plane	No	Allows unauthorized UEs to browse using a proxy UE
8111	TCP	Any	vSZ control plane	No	Allows authorized UEs to browse using a proxy UE
9080	HTTP	Any	vSZ control plane	No	Northbound Portal Interface for hotspots
9443	HTTPS	Any	vSZ control plane	No	Northbound Portal Interface for hotspots
9998	TCP	Any	vSZ control plane	No	Hotspot WISPr subscriber portal login/logout over HTTPS
3333	TCP	Controller	License server	No	Local license server
3799	UDP	External AAA Server (free Radius)	SZ-RAC	No	Supports Disconnect Message and CoA (Change Of Authorization) which allows dynamic changes to a user session such as disconnecting users and changing authorizations applicable to a user session.
443	HTTPS	Controller	License server	No	Cloud license server

TABLE 41 Ports to open for AP-SCG/SZ/vSZ/vSZ-D communication (continued)

Port Number	Layer 4 Protocol	From (Sender)	To (Listener)	Configurable from Web Interface?	Purpose
9996	TCP	Client	Controller interface	No	HotSpot 2.0 portal for onboarding and remediation
9999	TCP	Client	Controller interface	No	HotSpot 2.0 trust CA verification
8200	TCP	Client	Controller interface	No	HotSpot 2.0 Oauth in HTTP
8222	TCP	Client	Controller interface	No	HotSpot 2.0 Oauth in HTTPS

NOTE

The destination interfaces are meant for three interface deployments. In a single interface deployment, all the destination ports must be forwarded to the combined management/control interface IP address.

NOTE

Communication between APs is not possible across NAT servers.

SoftGRE Support

- Overview of SoftGRE Support..... 313
- Configuring And Monitoring AP Zones.....315
- SoftGRE SNMP MIBs.....316
- SoftGRE Events and Alarms.....317

This appendix describes the SoftGRE support that the controller provides and the supported deployment topology.

Overview of SoftGRE Support

There are numerous equipment vendors serving the service provider market today. Among these vendors, the more prominent ones include Alcatel-Lucent (ALU), Ericsson, NSN, Huawei and Cisco. Most of these vendors support different tunneling and mobility management protocols at their packet gateways.

Since most (if not all) of these equipment vendors do not develop access points themselves, they are publishing SoftGRE specifications to enable access point vendors (such as Ruckus Wireless) to support SoftGRE on their devices.

Supported Deployment Scenario

The controller supports SoftGRE in the deployment scenario wherein the controller functions purely as an AP controller. In this deployment topology, the controller only manages the Ruckus Wireless APs and does not perform other functions. All control paths (RADIUS Authentication/Accounting) and data paths (SoftGRE tunnel) terminate on the third party WLAN gateway.

If 802.1x authentication is used, the RADIUS server will be outside of the SoftGRE tunnel. If open, WISPr-based authentication is used, the portal or redirect function will be on the edge router or northbound of the edge router. The controller does not play any role in the control and data path functions.

FIGURE 145 The controller as a pure AP controller

Direct AP to GW Tunnel Solution

Distributed WAG & Centralized WAC

SCG-200 <-> AP Mgmt & 7750 <-> WAG Authentication & Data Plane AP

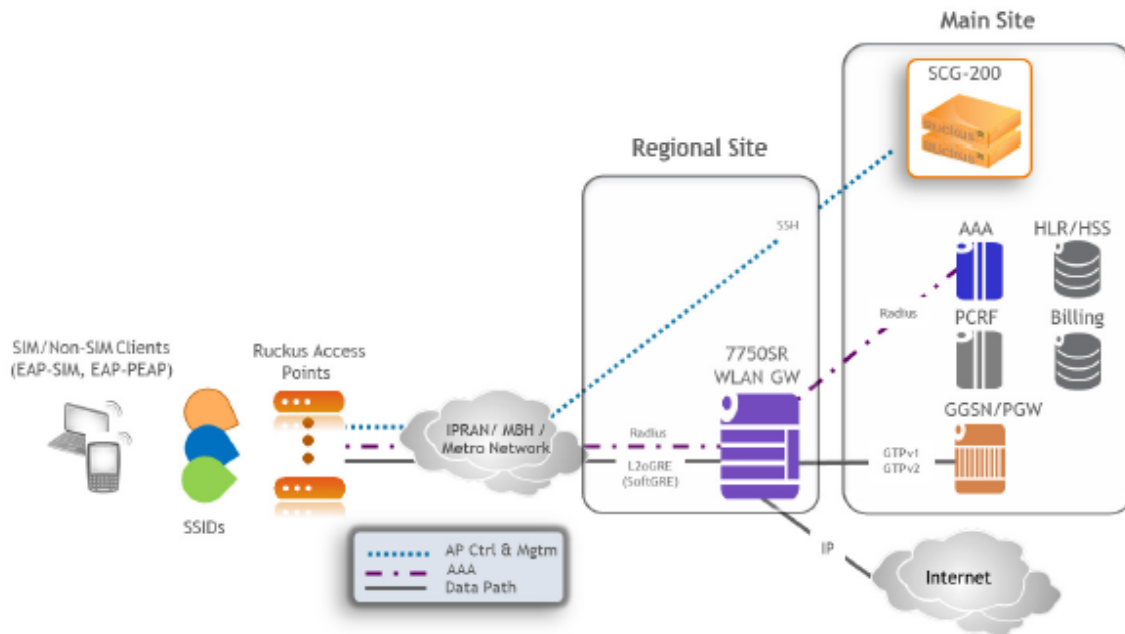

SoftGRE Packet Format

The following figure displays a screen shot of SoftGRE packet capture data.

FIGURE 146 Example of SoftGRE packet format

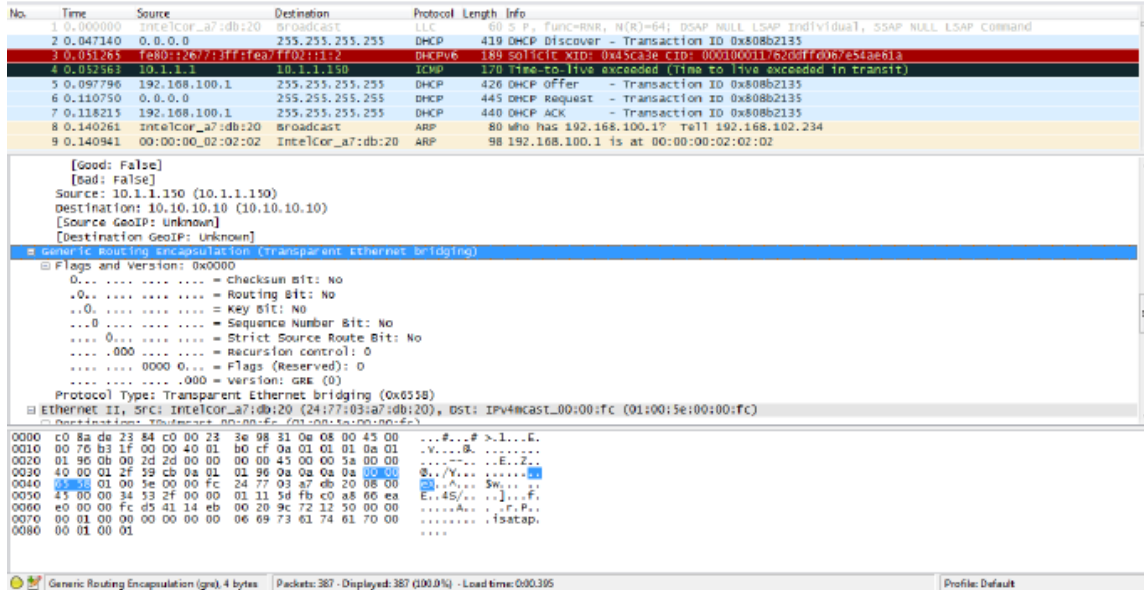

Configuring And Monitoring AP Zones

If no tunneled WLANs exist in the zone, you can change the tunnel type from SoftGRE to GRE or GRE + UDP.

MVNO accounts are currently unsupported by SoftGRE tunnels. If you create an MVNO account and assign an AP zone that is using a SoftGRE tunnel, an error message appears.

1. Follow the steps as described in [Monitoring Domains, Zones, and AP Groups](#) on page 91 to change the tunnel type from SoftGRE.
2. Scroll down to the **AP GRE Tunnel Option** section.
3. In **AP Tunnel Type**, select the tunnel type to which you want to change from SoftGRE.

If you attempt to change the tunnel type when a tunneled WLAN exists within the zone, the following error message appears:

Unable to update the configuration of the AP zone. Reason: It is disallowed to change the tunnel type, because it has tunneled WLAN.

4. Click **OK**.

The zone configuration information is displayed.

FIGURE 147 Monitoring Zone Configuration

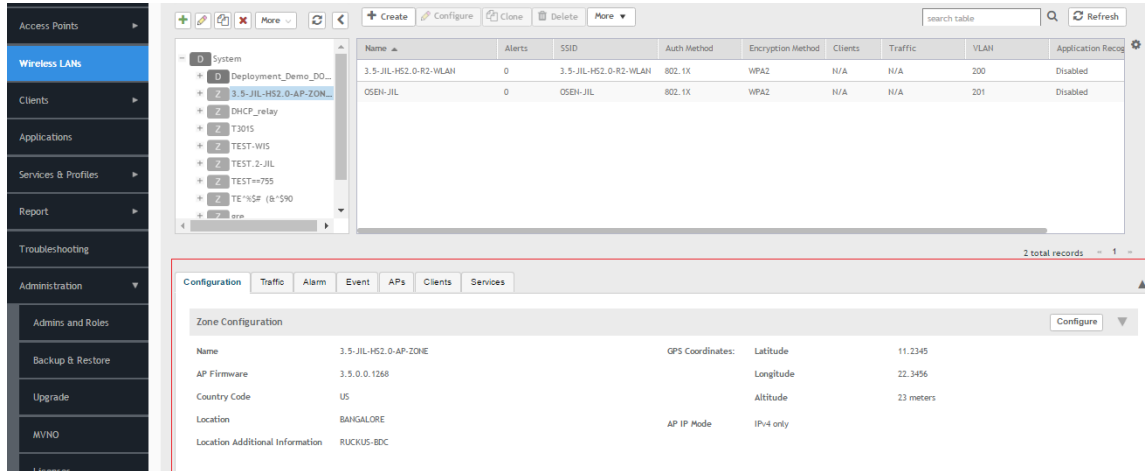

SoftGRE SNMP MIBs

The following table lists the SoftGRE OIDs.

TABLE 42 OIDs related to SoftGRE

Parent Node	Node Name	OID
ruckusWLANAPInfo	ruckusSCGWLANAPMacAddr	1.3.6.1.4.1.25053.1.3.2.1.1.2.3.1.1
	ruckusSCGWLANAPSoftGREServer	1.3.6.1.4.1.25053.1.3.2.1.1.2.3.1.2
	ruckusSCGWLANAPSoftGREGWAddr	1.3.6.1.4.1.25053.1.3.2.1.1.2.3.1.3
	ruckusSCGWLANAPSoftGREActive	1.3.6.1.4.1.25053.1.3.2.1.1.2.3.1.4
	ruckusSCGWLANAPSoftGRETxPkts	1.3.6.1.4.1.25053.1.3.2.1.1.2.3.1.5
	ruckusSCGWLANAPSoftGRETxBytes	1.3.6.1.4.1.25053.1.3.2.1.1.2.3.1.6
	ruckusSCGWLANAPSoftGRERxPkts	1.3.6.1.4.1.25053.1.3.2.1.1.2.3.1.7
	ruckusSCGWLANAPSoftGRERxBytes	1.3.6.1.4.1.25053.1.3.2.1.1.2.3.1.8
	ruckusSCGWLANAPSoftGRETxPktsErr	1.3.6.1.4.1.25053.1.3.2.1.1.2.3.1.9
	ruckusSCGWLANAPSoftGRERxPktsErr	1.3.6.1.4.1.25053.1.3.2.1.1.2.3.1.10
	ruckusSCGWLANAPSoftGRETxPktsDropped	1.3.6.1.4.1.25053.1.3.2.1.1.2.3.1.11
	ruckusSCGWLANAPSoftGRERxPktsDropped	1.3.6.1.4.1.25053.1.3.2.1.1.2.3.1.12
	ruckusSCGWLANAPSoftGRETxPktsFrag	1.3.6.1.4.1.25053.1.3.2.1.1.2.3.1.13
	ruckusSCGWLANAPSoftGREICMPTotal	1.3.6.1.4.1.25053.1.3.2.1.1.2.3.1.14
	ruckusSCGWLANAPSoftGREICMPNoReply	1.3.6.1.4.1.25053.1.3.2.1.1.2.3.1.15
	ruckusSCGWLANAPSoftGREDisconnect	1.3.6.1.4.1.25053.1.3.2.1.1.2.3.1.16

SoftGRE Events and Alarms

If there is no downstream traffic in the tunnel, APs that belong to the zone configured for SoftGRE send out-of-band ICMP keep-alive messages (interval is configurable) to the active third party WLAN gateway. If an AP does not receive a response from the active WLAN gateway, it triggers an alarm and it automatically creates a SoftGRE tunnel to the standby WLAN gateway.

If the AP does not receive a response from the standby WLAN gateway either, the AP disconnects all tunneled WLAN services. It continues to send keep-alive messages to both the active WLAN gateway (primary GRE remote peer) and standby WLAN gateway (secondary GRE remote peer). If it receives a response from either WLAN gateway, the AP restores all tunneled WLAN services automatically.

There are four types of events that APs send to the controller:

- Failover from primary GRE remote peer to secondary GRE remote peer
- Failover from secondary GRE remote peer to primary GRE remote peer.
- Tunnel disconnected because both primary and secondary GRE remote peers are unreachable
- Tunnel restored because either primary or secondary GRE remote peer is reachable

For the list of alarms and events related to SoftGRE that APs generate, refer to [SoftGRE Events](#) on page 317 and [SoftGRE Alarms](#) on page 318.

SoftGRE Events

SoftGRE related events that APs send to the controller.

Following are the events related to SoftGRE that AP generates.

apSoftGRE Tunnel FailoverPtoS AP [{apname@apMac}] fails over from primaryGRE [{address}] to secondaryGRE [{address}].

Code: 611

Severity:

Attributes:

- "apMac"="xx:xx:xx:xx:xx:xx"
- "primaryGRE"="xxx.xxx.xxx.xxx"
- "secondaryGRE"="xxx.xxx.xxx.xxx"

apSoftGRE Tunnel FailoverStoP AP [{apname@apMac}] fails over from secondaryGRE [{address}] to primaryGRE [{address}].

loverStoP

Code: 612

Severity: Warning

Attributes:

- "apMac"="xx:xx:xx:xx:xx:xx"
- "secondaryGRE"="xxx.xxx.xxx.xxx"
- "primaryGRE"="xxx,xxx.xxx.xxx"

apSoftGRE Gateway Reachable AP [{apname@apMac}] is able to reach [{softgreGW}] [{softgreGWAddress}] successfully.

Reachable

Code: 613

Severity: Informational

Attributes:

- "apMac"="xx:xx:xx:xx:xx:xx"
- "softgreGW"="primaryGRE"
- "softgreGWAddress" = "xxx.xxx.xxx.xxx"

apSoftGRE Gateway NotReachable AP [{apname@apMac}] is able to reach [{softgreGW}] [{softgreGWAddress}] successfully.

NotReachable

Code: 614

Severity: Critical

Attributes:

- apMac="xx:xx:xx:xx:xx:xx"
- "softGREGatewayList"="xxx.xxx.xxx.xxx, yyy,yyy.yyy.yyy"

SoftGRE Alarms

SoftGRE related alarms that APs send to the controller.

Following are the SoftGRE related alarms:

apSoftGRE Tunnel Fail AP[{apname@apMac}] fails over from primaryGRE[{address}] to secondaryGRE[{address}]

loverPtoS

Code: 611

Default to Trap: true

Severity: major

Attributes:

- "apMac"="xx:xx:xx:xx:xx:xx"
- "primaryGRE"="xxx.xxx.xxx.xxx"
- "secondaryGRE"="xxx.xxx.xxx.xxx"

apSoftGRE Tunnel Fail AP[{apname@apMac}] fails over from secondaryGRE[{address}] to primaryGRE[{address}]

loverStoP

Code: 612

Default to Trap: true

Severity: major

Attributes:

- "apMac"="xx:xx:xx:xx:xx:xx"
- "secondaryGRE"="xxx.xxx.xxx.xxx"
- "primaryGRE"="xxx,xxx.xxx.xxx"

apSoftGRE Gateway AP [{apname@apMac}] is able to reach [{softgreGW}] [{softgreGWAddress}] successfully

Reachable

Code: 613

Default to Trap: true

Severity: informational

Attributes:

- "apMac"="xx:xx:xx:xx:xx:xx"
- "softgreGW"="primaryGRE"
- "softgreGWAddress"="xxx.xxx.xxx.xxx"

apSoftGRE Gateway AP [{apname@apMac}] is unable to reach the following gateways: [{gateway list}]

NotReachable

Code: 614

Default to Trap: true

Severity: major

Attributes:

- "apMac"="xx:xx:xx:xx:xx:xx"
- "softGREGatewayList"="xxx.xxx.xxx.xxx, yyy,yyy.yyy.yyy"

Replacing Hardware Components

- [Installing or Replacing Hard Disk Drives.....319](#)

This appendix describes how to replace hardware components (including hard disk drives, power supply units, and system fans) on the controller.

This section only describes replacing the hardware components for SCG200.

Installing or Replacing Hard Disk Drives

You can install up to six hot-swappable SAS or SATA hard disk drives on the controller. The drives go into carriers that connect to the SAS/SATA backplane board once the carriers with drives attached are inserted back into the drive bays. The controller ships with six drive carriers.



CAUTION

If you install fewer than six hard disk drives, the unused drive bays must contain the empty carriers that ship with the server to maintain proper cooling.

Ordering a Replacement Hard Disk

To order a replacement hard disk for the controller, contact your Ruckus Wireless sales representative and place an order for FRU part number 902-0188-0000 (Hard Drive, 600GB, 10K RPM, 64MB Cache 2.5 SAS 6Gb/s, Internal).



CAUTION

Use only FRU part number 902-0188-0000 as replacement hard disk for the controller. Using other unsupported hard disks will render the controller hardware warranty void.

Removing the Front Bezel

You must remove the front bezel to add or replace a hard drive in one of the drive bays. It is not necessary to remove the front chassis cover or to power down the system. The hard drives are hot-swappable.

Follow these steps to remove the front bezel of the controller.

You need to remove the front bezel for tasks such as:

- Installing or removing hard disk drives or an SD flash card
- Observing the individual hard disk drive activity/fault indicators
- Replacing the control panel LED/switch board

The server does not have to be powered down just to remove the front bezel.

1. Loosen the captive bezel retention screw on the right side of the bezel (see A in [Figure 148](#)).
2. Rotate the bezel to the left to free it from the pins on the front panel (see B in [Figure 148](#)), and then remove it.

FIGURE 148 Removing the front bezel

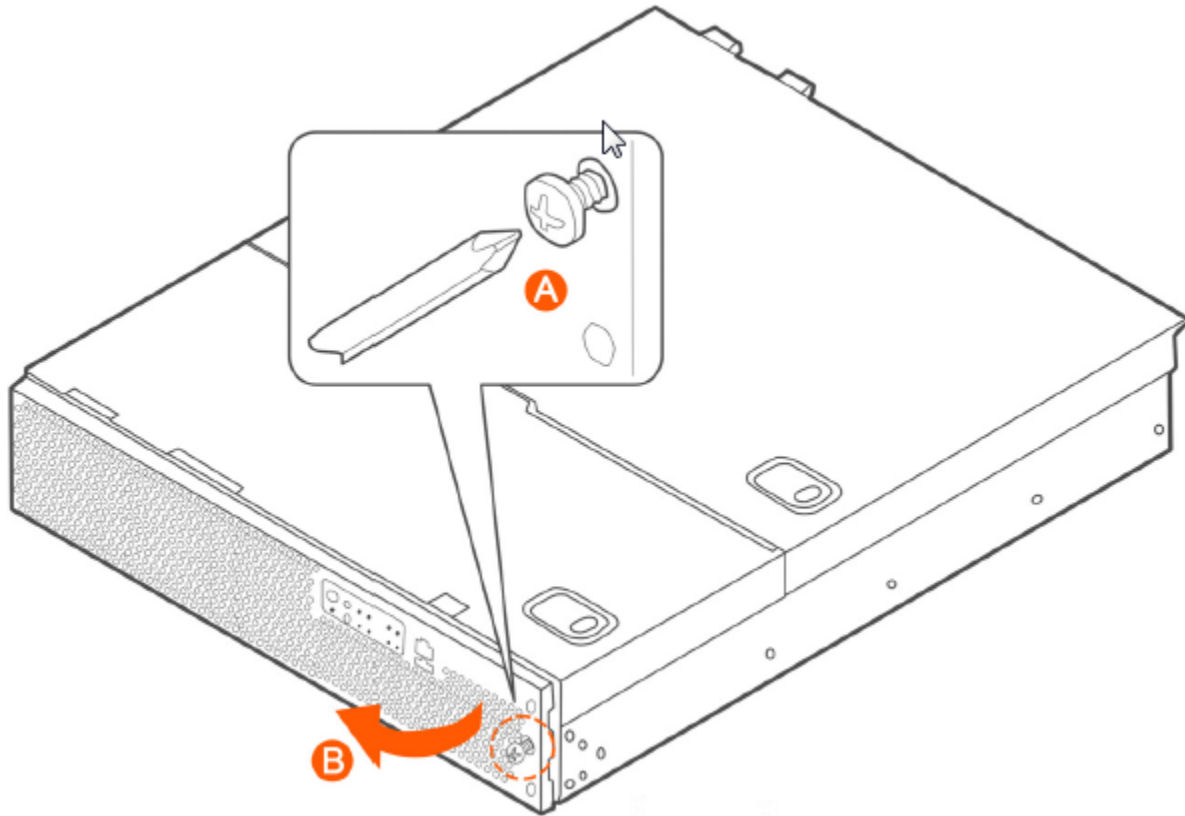

Removing an HDD Carrier from the Chassis

Follow these steps to remove a hard disk drive carrier from the chassis.

1. Remove the front bezel (see [Removing the Front Bezel](#) on page 319).

2. Select the drive bay where you want to install or replace the drive.

Drive bay 0 must be used first, then drive bay 1 and so on. The drive bay numbers are printed on the front panel below the drive bays.

3. Remove the drive carrier by pressing the green button to open the lever.

(See A in [Figure 149](#)).

4. Pull the drive carrier out of the chassis.

FIGURE 149 Removing the drive carrier

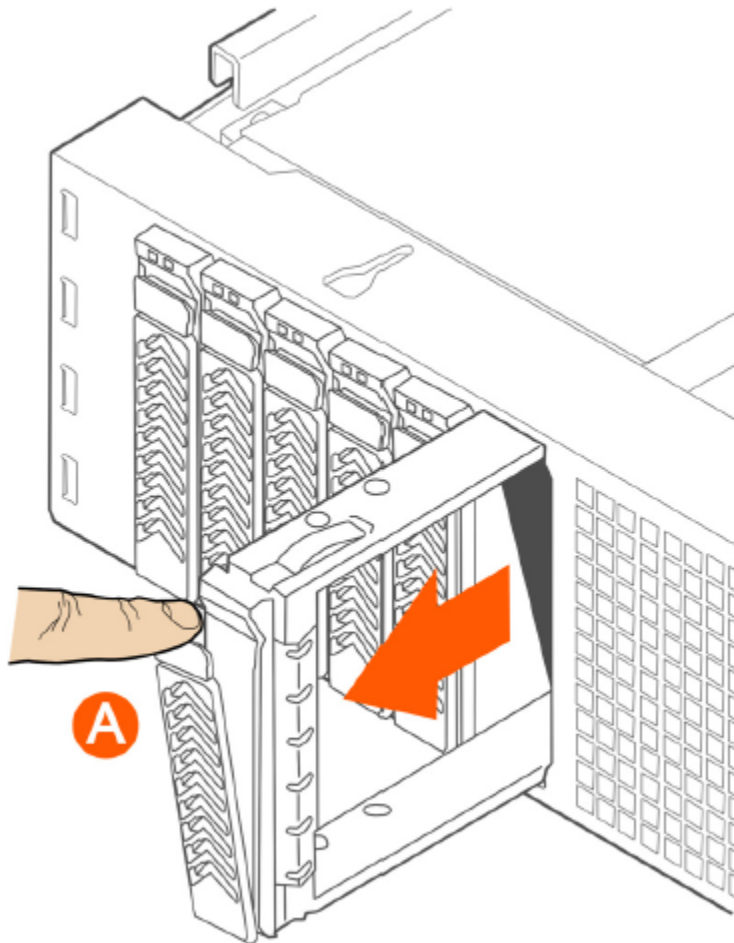

Installing a Hard Drive in a Carrier

Follow these steps to install a hard drive in a drive carrier.

1. If a drive is already installed (that is, if you are replacing the drive), remove it by unfastening the four screws that attach the drive to the drive carrier (see A in [Figure 150](#)). Set the screws aside for use with the new drive.

2. Lift the drive out of the carrier (see B in Figure 150).

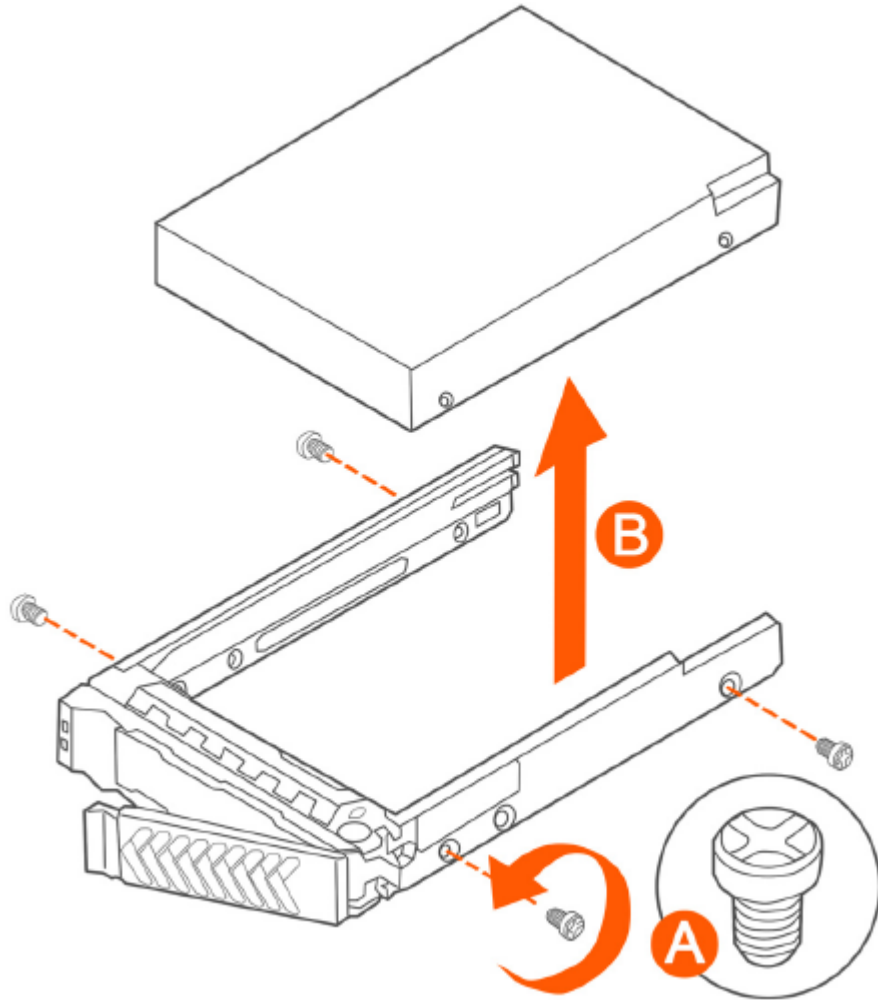

FIGURE 150 Removing the hard drive

3. Install the new drive in the drive carrier (see A in Figure 151), and then secure the drive with the four screws that come with the carrier (see B).

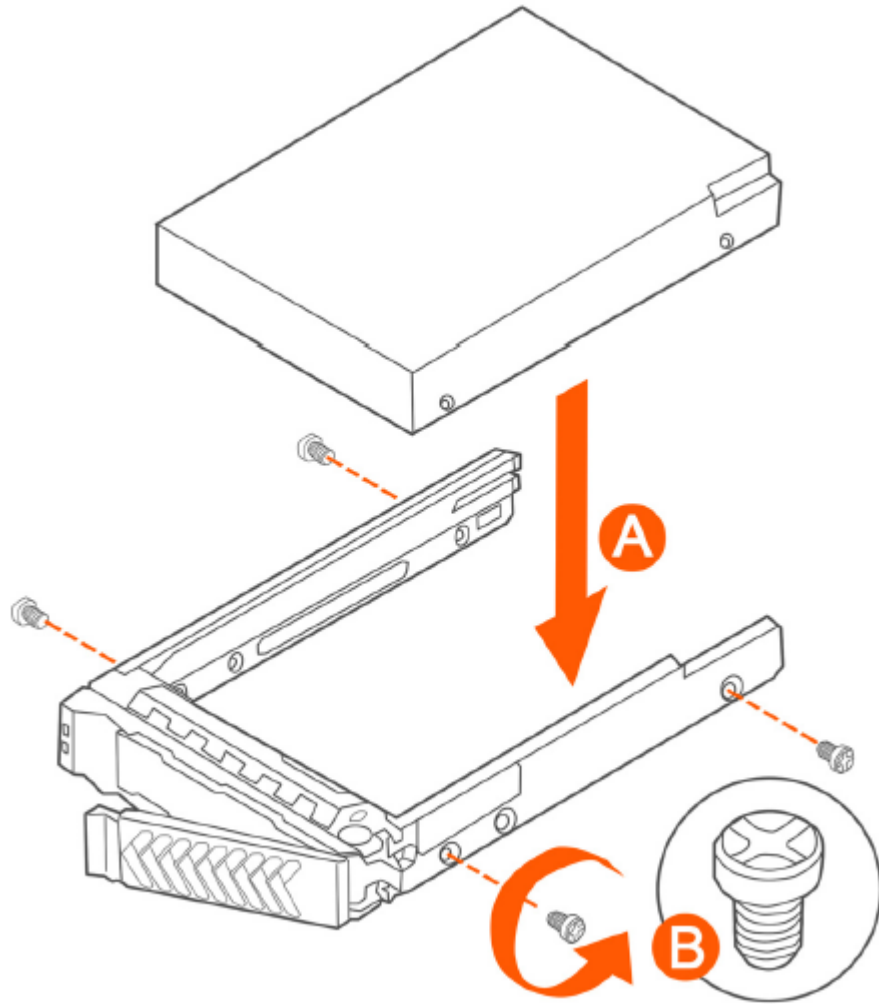

FIGURE 151 Installing the hard drive

4. With the drive carrier locking lever fully open, push the hard drive carrier into the drive bay in the chassis until it stops (see A in Figure 152).

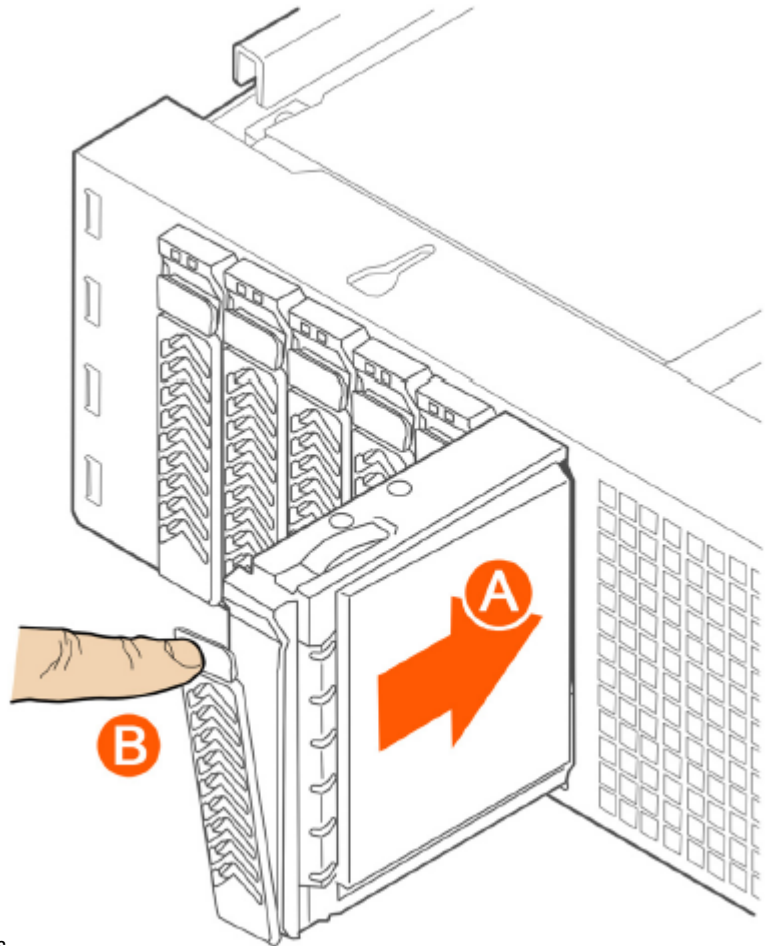

FIGURE 152 Inserting the carrier back into the chassis

5. Press the locking lever until it snaps shut and secures the drive in the bay.

You have completed installing or replacing the hard drive onto the controller.

NOTE

The new hard drive will synchronize automatically with the existing RAID array. During the synchronization process, the HDD LED on the controller will blink amber and green alternately. When the process is complete, the HDD LED will turn off.

Reinstalling the Front Bezel

Follow these steps to reinstall the front bezel on the controller.

1. Insert the tabs on the left side of the bezel into the slots on the front panel of the chassis.
2. Move the bezel toward the right of the front panel and align it on the front panel pins.
3. Snap the bezel into place and tighten the retention screw to secure it.

Replacing PSUs

The controller includes two redundant, hot-swappable power supply units (2 AC PSUs or 2 DC PSUs). No chassis components need to be removed to add or replace a PSU.

Follow these steps to remove and replace a PSU.

1. Identify the faulty PSU by looking at the PSU status LED (red indicates PSU failure, green indicates normal operation).
2. Press and hold the green safety lock downward while grasping the PSU handle.
3. Pull outward on the handle, sliding the PSU all the way out of the rear of the machine.
4. Insert the new PSU into the slot and, while holding the green safety lock, slide the PSU into the slot until it locks in place.

The PSU status LED turns green, indicating that the PSU is operating normally.

NOTE

If you are installing a DC power supply, there are two threaded studs for chassis enclosure grounding. A 90° standard barrel, two-hole, compression terminal lug with 5/8-inch pitch suitable for a #14-10 AWG conductor must be used for proper safety grounding. A crimping tool may be needed to secure the terminal lug to the grounding cable.

FIGURE 153 Replacing a PSU

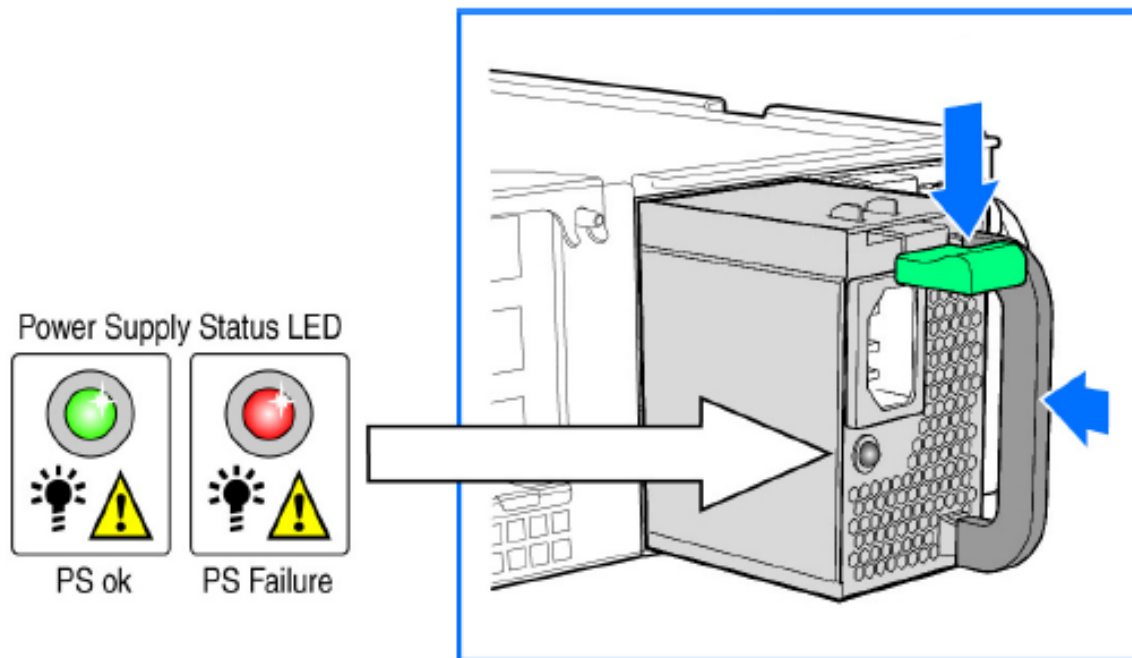

Replacing System Fans

The controller includes six redundant, hot-swappable system fans (four 80mm fans and two 60mm fans). There are also two fans located inside the power supply units. Redundancy for the two PSU fans is only achieved when both PSUs are installed.

If any of the system fans requires replacement, the replacement procedure is identical.

Electrostatic discharge (ESD) can damage internal components such as printed circuit boards and other parts. Ruckus Wireless recommends that you only perform this procedure with adequate ESD protection. At a minimum, wear an anti-static wrist strap attached to the ESD ground strap attachment on the front panel of the chassis.

Replacing Hardware Components

Installing or Replacing Hard Disk Drives

Follow these steps to replace a system fan.

1. Open the front chassis cover of the controller. It may be necessary to extend the controller into a maintenance position.
2. Identify the faulty fan. Each fan has a "service required" LED that turns amber when the fan is malfunctioning.
3. Remove the faulty fan by grasping both sides of the fan assembly, using the plastic finger guard on the left side and pulling the fan out of the metal fan enclosure.
4. Slide the replacement fan into the same metal fan enclosure. Use the edges of the metal enclosure to align the fan properly and ensure the power connector is seated properly in the header on the side of the enclosure.
5. Apply firm pressure to fully seat the fan.
6. Verify that the (service required) LED on the top of the fan is not lit.

7. Close the front chassis cover and return the controller to its normal position in the rack, if necessary.

FIGURE 154 Replacing a system fan

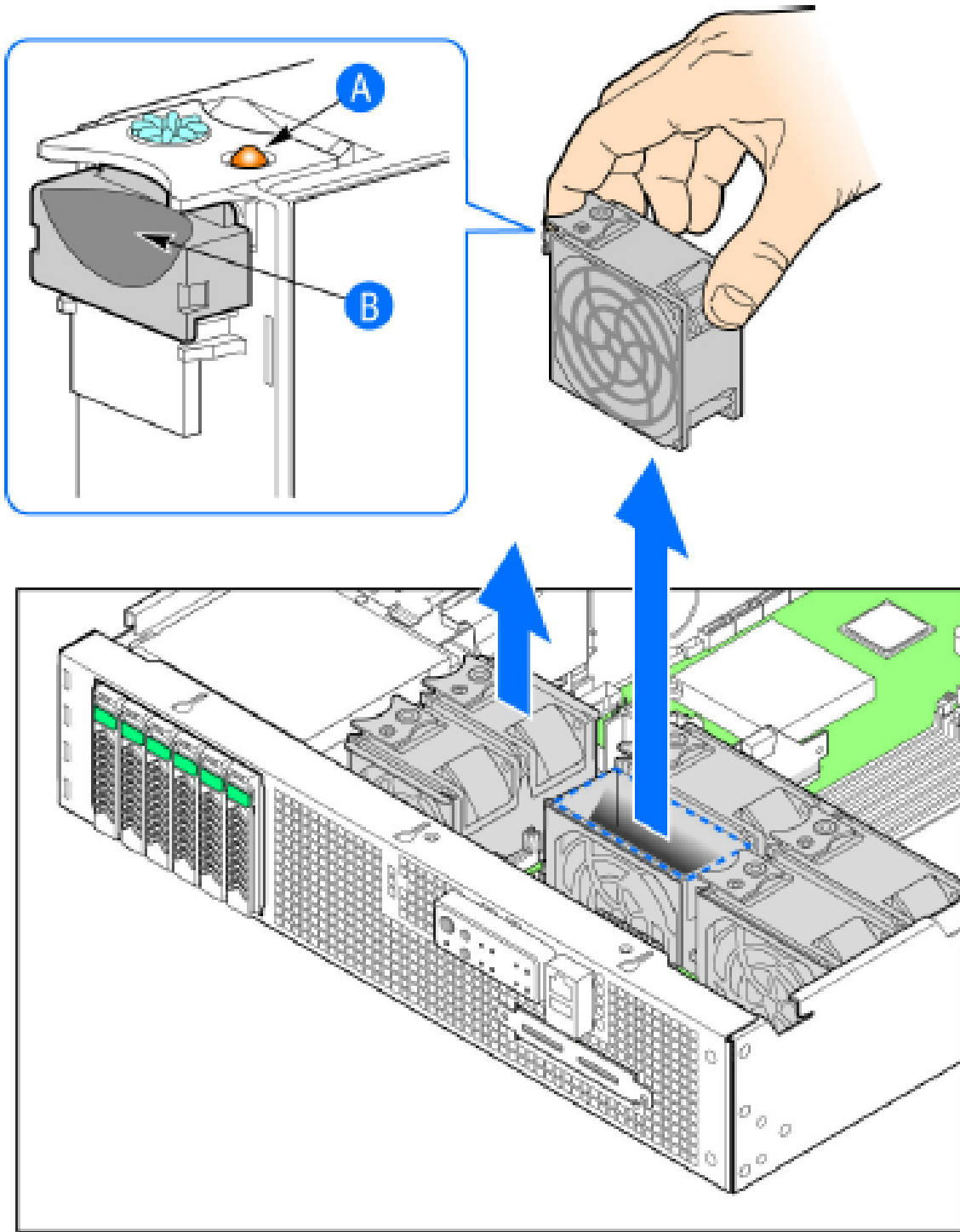

Replacing a Controller Node

- [Introduction.....](#) 329
- [Backing Up and Resorting the Cluster.....](#) 329
- [Backing Up and Restoring Configuration.....](#) 335

Introduction

NOTE

The information in this section only applies to the SCG-200.

This section describes how to back up cluster and configuration data and replace a controller node.

The following are required to perform the procedures described in this guide.

1. A remote FTP server with at least 50GB of free disk space. You must create an FTP account (user name and password) before starting these procedures.
2. If you are restoring to a multi node cluster environment, all backup files must be taken around the same time. If the backup files are out-of-sync, the restore process may be unsuccessful.

Backing Up and Resorting the Cluster

Cluster backup creates a backup of the entire cluster.

Take note of the following before performing a cluster backup.

- The cluster backup file is typically very large (larger than 1GB).
- Cluster backup cannot be completed successfully if any one of the nodes has less than 50GB of disk space after the backup process.

Step 1: Backing Up the Cluster from the Web Interface

For information on how to back up the cluster from the controller web interface, see [Creating a Cluster Backup](#) on page 275.

Step 2: Back Up the Cluster from the Controller CLI

Cluster backup creates a backup of the entire cluster.

Follow the steps to back up the cluster from the controller CLI.

1. Log on to the controller CLI as a system administrator.
2. Run the **enable** command to enable privileged mode on the CLI.

```
ruckus> enable
Password: *****
ruckus#
```

Replacing a Controller Node

Backing Up and Resorting the Cluster

3. Run the **show diskinfo** command to determine the current disk size of the node.

To complete the cluster backup successfully, the /mnt directory must have at least 50GB (53,687,091,200 in 1K-blocks) of free disk space.

```
ruckus# show diskinfo
Filesystem      1K-blocks      Used Available Use% Mounted on
rootfs          4128448        315520  3603216   9% /
/dev/root       4128448        315520  3603216   9% /
/dev/sda1       2064208         97208  1862144   5% /boot
/dev/mapper/vg00-lv00
41276736 5646756 33533240 15% /mnt
tmpfs           1048576         696    1047880   1% /tmp
tmpfs           3066864         0     3066864   0% /dev/shm
```

4. Run the **backup** command to start the backing up the current cluster.

```
ruckus# backup
Do you want to backup system in this context (yes/no)? yes
Backup process starts.
Backup process has been scheduled to run. You can check backup version using 'show backup'.
```

5. Run the **show backup** command to verify that the cluster backup file has been created successfully.

Step 3: Transfer the Cluster Backup File to an FTP Server

1. Log on to the controller **CLI** as a system administrator.
2. Enable privileged mode on the **CLI**.

```
ruckus> enable
Password: *****
ruckus#
```

3. Run the **copy backup** command to copy the cluster backup file to an FTP server as shown in the figure.

FIGURE 155 Command to copy the cluster backup file

```
NMS33# copy backup
tftp      Transfer by TFTP
<ftp-url> FTP directory URL, Format: ftp://<username>:<password>@<ftp-host>[/<dir-path>]

NMS33# copy backup ftp://bala:ruckus@172.19.7.23
Please note that event, alarm and statistic data will not be saved in the exported backup file.

  No.   Created on                Patch Version                File Size
-----
  1     2015-11-04 05:54:11 GMT      3.4.0.0.108                  937.5MB
  2     2015-11-16 05:32:53 GMT      3.4.0.0.223                  1.2GB

Please choose a backup to send to remote FTP server or 'No' to cancel: 1
Starting to copy the chosen backup to remote FTP server...
Starting to encrypt backup file...
Succeed to copy to remote FTP server
Successful operation

NMS33# █
```

NOTE

The names of the backup files are automatically assigned by the controller based on the timestamp when the backup file was generated and the controller release version. To make it easy for you to identify the backup files, Ruckus Wireless strongly recommends moving each node's backup file to its own directory on the FTP server (for example, `//ftp/node1`) after the backup process is completed.

Step 4: Restoring the Cluster Backup to the Controller

The procedure for restoring the cluster backup to the controller depends on the controller environment – whether it is a single node environment or a multi-node environment.

Restoring to a Single Node Environment

The procedure for restoring the cluster backup to the controller depends on the controller environment – whether it is a single node environment or a multi-node environment.

Follow these steps to restore a cluster backup to a single node environment.

1. Prepare the new controller to which you will restore the cluster backup.
 - a) Either obtain a new controller or factory reset an existing controller.
 - b) Log on to the controller as a system administrator.
 - c) Run the setup command to configure the controller's network settings.

```
ruckus> setup
#####
Start SCG setup process:
#####
:
:
Setup configuration of ethers...
Network would be restarted. You could connect to SCG back by using Management port (10.2.2.35)!!
Enter "restart network" to continue... restart network
```

2. Transfer the backup file from the FTP server to the controller.
 - a) Log on to the controller **CLI** as a system administrator.
 - b) Run the **enable** command to enable privileged mode on the **CLI**.

```
ruckus> enable
Password: *****
ruckus#
```

- c) Run the **copy <ftp-url> backup** command to transfer the backup file from the FTP server to the controller.

```
ruckus# copy <ftp-url> backup
```

NOTE

If there is only one backup file on the FTP server, the system will automatically transfer this file to the controller. If there are multiple files, it will show the list of all available files and you will be prompted to select the file that you want to transfer.

3. Run the **restore local** command to restore the backup file to the controller.

```
ruckus# restore local
This action will REBOOT the system. Do you want to only restore this SCG node (yes/no)? yes
idx version date
-----
1 1.1.1.0.93 2013-02-01 03:09:27 GMT
2 1.1.1.0.93 2013-02-03 07:21:24 GMT
Please choose a backup version to restore (ex: 1, 2, ...): 2
You have completed restoring the backup file to a single node.
```

Restoring to a Multi-Node Environment

If you are restoring to a multi-node cluster, you can either replace only one node in the (still-healthy) cluster or replace multiple nodes in the cluster.

Replacing a Single Node in a Cluster

Follow these steps to replace a single node in a cluster backup.

1. If the node that you want to replace is still functioning, follow these steps to remove the node.
 - a) Choose a controller that will remain in the cluster.
 - b) Log on to that controller's web interface as an administrator.
 - c) Go to **System > Cluster**.
 - d) Locate the node that you want to replace in the cluster planes.
 - e) Click **Delete** to remove the node from the cluster.
2. If the node that you want to replace is out of service, you will need to shut it down before you can replace it. Follow these steps.
 - a) On the node that you want to replace, log on to the **CLI** as a system administrator.
 - b) Run the **enable** command to enable privileged mode on the **CLI**.

```
ruckus> enable
Password: *****
ruckus#
```

- c) (Optional) Back up the current controller system.
See [Step 2: Back Up the Cluster from the Controller CLI](#) on page 329.
- d) On the node that you want to replace, run the **shutdown** command.

```
ruckus# shutdown
```

- e) Log on to the controller web interface as a system administrator.
- f) Go to **System > Cluster**.
- g) Locate the node that you want to replace in the cluster planes.
- h) Click **Delete** to remove the node from the cluster.
- i) Set up the node as a new controller, and then join the existing cluster. For step by step instructions, see the *SmartCell Gateway 200 Getting Started Guide*.

Replacing Multiple Nodes in a Cluster

If the cluster itself is not healthy anymore or if multiple nodes need to be replaced, you must restore backup files taken around the same time to all of the nodes in the cluster.

Follow these steps to restore backups to multiple nodes in a cluster.



CAUTION

Backup files must be taken around the same time. If the backup file of one node is out of sync from the others, the restore process will be unsuccessful.

When restoring to multiple nodes, it is critical that you perform the restore process on all nodes at the same time.

Use the restore local command to restore the cluster from the backup file as you cannot restore the cluster by using a backup file from another cluster.

1. Log on to the CLI as a system administrator.
2. Run the **enable** command to enable privileged mode on the CLI.

```
ruckus> enable
Password: *****
ruckus#
```

3. Run the **remote restore** command to transfer the backup file from the FTP server to the controller.

```
ruckus# remote restore <ftp-username> <ftp-password> <ftp-server-address> <ftp-server-port>
<directory>
idx version date
-----
1 1.1.0.0.207 2012-10-16 06:46:07 GMT
2 1.1.0.0.209 2012-10-17 05:20:51 GMT
Please choose a backup version to get from remote FTP: 2
Remote restore process starts
Remote restore process completed
```

The ftp-server-port is optional.

NOTE

If there is only one backup file on the FTP server, the system will automatically transfer this file to the controller. If there are multiple files, it will show the list of all available files and you will be prompted to select the file that you want to transfer. If the backup files are in the root directory, use "/" in *{directory}*. If the backup files are in a subdirectory, use "{subdir}/{subdir}" to indicate the subdirectory in which the system should check.

4. After all backup files for all nodes have been transferred from the FTP server to the controller, run the **restore local** command to restore the backup file to the controller.

```
ruckus# restore local
This action will REBOOT the system. Do you want to only restore this SCG node (yes/no)? yes
idx version date
-----
1 1.1.1.0.93 2013-02-01 03:09:27 GMT
2 1.1.1.0.93 2013-02-03 07:21:24 GMT
Please choose a backup version to restore (ex: 1, 2, ...): 2
```

5. Verify that the following message appears on each node:

```
Remote restore process completed
```

This indicates that the node is ready for the restore process.

6. Once all nodes are ready for the restore process, run the restore command for all nodes at the same time.

Backing Up and Restoring Configuration

Configuration backup creates a backup of all existing configuration information on the controller. In addition to backing up a different set of information, configuration backup is different from cluster backup in a few ways:

- The configuration backup file is smaller, compared to the cluster backup file.
- The controller can be configured to back up its configuration to an external FTP server automatically.
- Configuration backup does not back up any statistical files or general system configuration.

Backed Up Configuration Information

The following list show which configuration information will be backing up.

- AP zones
- AP zone global configuration
- Zone templates
- WLAN templates
- AP registration rules
- Access point information
- General system settings
- Web certificate
- SNMP agent
- Alarm to SNMP agent
- Cluster planes
- Management interface ACL
- Domain information
- User credentials and information
- Mobile Virtual Network Operators (MVNO) information

Backing Up Configuration

There are two methods you can use to back up the controller configuration:

Backing Up Configuration from the Web Interface

1. For information on how to back up the controller configuration to an external FTP server automatically, see [Backing up Cluster Configuration](#) on page 284.
2. In **Auto Export Backup**, click **Enable**.
3. In **FTP Server**, select the FTP server to which you want to export the backup file.
4. Click **Test**. The controller attempts to establish connection to the FTP server using the user name and password that you supplied. If the connection attempt is successful, the following message appears: `FTP server connection established successfully`.
If the connection attempt is unsuccessful, verify that the FTP server details (including the user name and password) are correct, and then click **Test** again.

5. After you verify the controller is able to connect to the FTP server successfully, click **OK** to save the FTP server settings.

Backing Up Configuration from the CLI

There are two methods you can use to back up the controller configuration either using the web interface or CLI (Command Line Interface).

Follow these steps to back up the controller configuration from the **CLI**.

1. Log on to the controller **CLI** as a system administrator.
2. Run the **enable** command to enable privileged mode on the **CLI**.

```
ruckus> enable
Password: *****
ruckus#
```

3. Run the **backup config** command to start backing up and transferring the node configuration to an FTP server.

```
ruckus# backup config <ftp-username> <ftp-password> <ftp-server-address> <ftp-server-port>
Do you want to backup configuration (yes/no)? yes
Backup Configuration process starts
Backup Configuration process has been scheduled to run. You can check backup version using 'show
backup-config'
```

4. Run the **show backup-config** command to verify that the backup file has been created.

You have completed backing up the controller node to an external FTP server.

Restoring Configuration

Restoring Configuration to a Single Node Environment

Restoring the configured backup in a single node environment.

Follow the steps below to restore configuration to a single node environment.

1. Prepare the new controller to which you will restore the cluster backup.
 - a) Either obtain a new controller or factory reset an existing controller.
 - b) Log on to the controller as a system administrator.
 - c) Run the **setup** command to configure the controller's network settings.

```
ruckus> setup
#####
Start SCG setup process:
#####
:
:
Setup configuration of ethers...
Network would be restarted. You could connect to SCG back by using Management port (10.2.2.35)!!
Enter "restart network" to continue... restart network
```

- d) Complete the controller setup process from the **CLI**.
2. After you complete the controller setup, log on to the controller web interface as a system administrator.
 3. Go to **Administration > Backup and Restore**.
 4. Click the **Configuration** tab.
 5. Click **Upload**.
 6. Browse to the location (either on the local computer or on the network) of the configuration backup file that you want to restore.

7. Select the configuration backup file, and then click **Upload**.

When the upload process is complete, the backup file appears in the **Configuration** section.

8. Restore the configuration backup file to the node, either using the web interface or the **CLI**.
9. To use the web interface:
 - a) On the web interface, go to **Administration > Backup and Restore**.
 - b) In the **Configuration** tab, locate the configuration backup file that you want to restore, and then click **Restore**.
 - c) Follow the prompts (if any) to complete the restore process.
10. To use the **CLI**:
 - a) Log on to the **CLI** as a system administrator.
 - b) Run the **restore config** command.

```
ruckus# restore config
This action will REBOOT the system. Do you want to only restore this SCG node (yes/no)? yes
idx version date
-----
1 1.1.1.0.93 2013-02-01 03:09:27 GMT
2 1.1.1.0.93 2013-02-03 07:21:24 GMT
Please choose a backup version to restore (ex: 1, 2, ...): 2
```

- c) Follow the prompts (if any) to complete the restore process.

You have completed restoring the configuration to a single node controller.

Restoring Configuration to Multi Node Environment

If you are restoring to a multi node cluster, you can either replace only one node in the (still-healthy) cluster or replace multiple nodes in the cluster.

Restoring Configuration to a Single Node in a Cluster

Follow these steps to replace the configuration of a single node in a cluster.

1. If the node that you want to replace is still functioning, follow these steps to remove the node.
 - a) Choose a controller that will remain in the cluster.
 - b) Log on to that controller's web interface as an administrator.
 - c) Go to **System > Cluster**.
 - d) Locate the node that you want to replace.
 - e) Click **Delete** to remove the node from the cluster.

Replacing a Controller Node

Backing Up and Restoring Configuration

2. If the node that you want to replace is out of service, you will need to shut down the node before you can replace it. Follow these steps.

- a) On the node that you want to replace, log on to the **CLI** as a system administrator.
- b) Run the **enable** command to enable privileged mode on the **CLI**.

```
ruckus> enable
Password: *****
ruckus#
```

- c) (Optional) Back up the current controller system.
See [Step 2: Back Up the Cluster from the Controller CLI](#) on page 329.
- d) On the node that you want to replace, run the **shutdown** command.

```
ruckus# shutdown
```
- e) Log on to the controller web interface as a system administrator.
- f) Go to **System > Cluster**.
- g) Locate the node that you want to replace,
- h) Click **Delete** to remove the node from the cluster.
- i) Set up the node as a new controller, and then join the existing cluster. For step by step instructions, see the *SmartCell 200 Getting Started Guide*.

You have completed restoring configuration to a single node in the cluster.

Restoring Configuration to Multiple Nodes in a Cluster

If the cluster itself is not healthy anymore or if multiple nodes need to be replaced, you must factory reset all remaining nodes to ensure that configuration restore to the cluster will be successful.

Follow the steps to restore the configuration to multiple nodes in a cluster.

1. Prepare the new controller nodes and factory reset all of the existing nodes in the cluster.
2. Complete the setup procedure for one of the controller nodes.

For instructions, see the *SmartCell Gateway 200 Getting Started Guide* for this release.

3. After you complete the setup of one node, log on to the web interface of that node as a system administrator.
4. Go to **Administration > Backup and Restore**.
5. In the **Configuration** tab, click **Upload**.
6. Locate the configuration backup file that you want to restore.
7. Click **Upload**.

After the configuration file is uploaded successfully, it appears in the **Configuration** section.

8. Restore the configuration backup to the node either using the web interface or the CLI.
9. To use the web interface:
 - a) Go to **Administration > Backup and Restore** page.
 - b) In the **Configuration** tab, locate the configuration backup file that you want to restore.
 - c) Click **Restore**.
 - d) Follow the prompts (if any) to complete the restore process.

10. To use the **CLI**:

- a) Log on to the **CLI** of the node as a system administrator.
- b) Run the **restore config** command.

```
ruckus# restore config
This action will REBOOT the system. Do you want to only restore this SCG node (yes/no)? yes
idx version date
-----
1 1.1.1.0.93 2013-02-01 03:09:27 GMT
2 1.1.1.0.93 2013-02-03 07:21:24 GMT
Please choose a backup version to restore (ex: 1, 2, ...): 2
```

- c) When the configuration restore process on this node is complete, set up the next node and configure it to join the existing cluster.

You have completed restoring configuration backup to multiple nodes in a cluster.

SCG SSID Syntax

- SSIDs Supported in Release 1.1.x.....341
- SSIDs Supported in Release 2.1.x.....341
- SSIDs Supported in Release 2.5.x.....342
- SSIDs Supported in Release 3.0 and Above.....342
- ZoneDirector SSID Syntax.....343
- ZoneFlex AP SSID Syntax.....344

The following sections describe the supported SSID syntax in the following SCG release versions:

SSIDs Supported in Release 1.1.x

Release 1.1.x supports a specific set of SSID syntaxes, which may be different from the syntaxes supported in other releases.

The following table describes the SSID syntaxes that are supported in release 1.1.x.

TABLE 43 Supported SSID syntaxes in 1.1.x

Web Interface	Length	Between 1 and 32 characters, including characters from printable characters (ASCII characters space (32) to ~ (126))
	Supported Characters	<ul style="list-style-type: none"> • A-Z • a-z • 0-9 • _space_!"#\$%&'()*+,-./ • ;:<=?@ • [^_` • {}
CLI	Length	Unsupported
	Supported Characters	Unsupported

SSIDs Supported in Release 2.1.x

Release 2.1.x supports a specific set of SSID syntaxes, which may be different from the syntaxes supported in other releases.

The following table describes the SSID syntaxes that are supported in release 2.1.x.

TABLE 44 Supported SSID syntaxes in 2.1.x

Web Interface	Length	Between 1 and 32 characters, including characters from printable characters (ASCII characters space (32) to ~ (126))
	Supported Characters	<ul style="list-style-type: none"> • A-Z • a-z • 0-9 • _space_!"#\$%&'()*+,-./ • ;:<=?@

SCG SSID Syntax

SSIDs Supported in Release 2.5.x

TABLE 44 Supported SSID syntaxes in 2.1.x (continued)

		<ul style="list-style-type: none">• [] ^ _ `• { }
CLI	Length	Between 2 and 32 characters
	Supported Characters	All characters, but the space character cannot be the first or last character in the SSID

SSIDs Supported in Release 2.5.x

Release 2.5.x supports a specific set of SSID syntaxes, which may be different from the syntaxes supported in other releases.

The following table describes the SSID syntaxes that are supported in release 2.5.x.

TABLE 45 Supported SSID syntax in 2.5.x

Web Interface	Length	Between 1 and 32 characters, including characters from printable characters (ASCII characters space (32) to ~ (126))
	Supported Characters	<ul style="list-style-type: none">• A-Z• a-z• 0-9• _space_! "#\$%&'()*+,-./• ;<=?@• [] ^ _ `• { }
CLI	Length	Between 2 and 32 characters
	Supported Characters	All characters

SSIDs Supported in Release 3.0 and Above

Release 3.0 and above supports a specific set of SSID syntaxes, which may be different from the syntaxes supported in other releases.

The following table describes the SSID syntaxes that are supported in release 3.0 and above.

TABLE 46 Supported SSID syntax in 3.0 and above

Web Interface and CLI	Length	Between 2 to 32 characters are supported
	Characters	Unsupported: ` and \$(Space is allowed, but it must include at least one non-space character (" abc" is valid, however only space such as " " is invalid). NOTE One Chinese word is regarded as three special characters.

ZoneDirector SSID Syntax

The following sections describe the supported SSID syntax in the following SCG release version:

SSIDs Supported in Releases 9.8 and 9.7

ZoneFlex releases 9.8 and 9.7 support a specific set of SSID syntaxes, which may be different from the syntaxes supported in other releases.

TABLE 47 Supported SSID syntaxes in ZoneFlex 9.8 and 9.7

Web Interface	Length	Between one and 32 characters
	Supported Characters	All printable ASCII characters from space (32) to ~(126)
	Exceptions	The space character (32) cannot be the first or last character in the SSID. Otherwise, the following error message appears: can only contain between 1 and 32 characters, including characters from ! (char 33) to ~ (char 126).
CLI	Length	Between one and 32 characters
	Supported Characters	All printable ASCII characters from space (32) to ~(126)
	Exceptions	The space character (32) can be placed anywhere in the SSID (including the beginning or end) provided that it enclosed by a double quotation mark.

Supported SSIDs in ZoneFlex Release 9.6

ZoneFlex release 9.6 supports a specific set of SSID syntaxes, which may be different from the syntaxes supported in other releases.

TABLE 48 Supported SSID syntaxes in ZoneFlex 9.6

Web Interface	Length	Between two and 32 characters
	Supported Characters	All printable ASCII characters from space (32) to ~(126)
	Exceptions	The space character (32) cannot be the first or last character in the SSID. Otherwise, the following error message appears: can only contain between 1 and 32 characters, including characters from ! (char 33) to ~ (char 126).
CLI	Length	Between two and 32 characters
	Supported Characters	All printable ASCII characters from space (32) to ~ (126)
	Exceptions	The space character (32) can be placed anywhere in the SSID (including the beginning or end) provided that it enclosed in a double quotation mark (for example, "Ruckus Wireless SSID").

ZoneFlex AP SSID Syntax

The following sections describe the supported SSID syntax in the following ZoneFlex AP release versions:

Supported SSIDs in Releases 9.8, 9.7, and 9.6

ZoneFlex release 9.8, 9.7, and 9.6 support a specific set of SSID syntaxes, which may be different from the syntaxes supported in other releases.

TABLE 49 Supported SSID syntaxes in ZoneFlex AP 9.8, 9.7, and 9.6

Web Interface	Length	Between one and 32 characters
	Supported Characters	All printable ASCII characters from space (32) to ~ (126)
CLI	Length	Between one and 32 characters
	Supported Characters	All printable ASCII characters from space (32) to ~ (126)
	Exceptions	The space character (32) can be placed anywhere in the SSID (including the beginning or end) provided that it enclosed in a double quotation mark (for example, "Ruckus Wireless SSID"). If the space character is not enclosed in a double quotation mark, the space character and any characters after that will be ignored. For example, if you run the command "set ssid wlan0 ruckus-ap 123" , the controller CLI will run the command as "set ssid wlan0 ruckus-ap 123" .



Copyright © 2006-2017. Ruckus Wireless, Inc.
350 West Java Dr. Sunnyvale, CA 94089. USA
www.ruckuswireless.com